

# Owner's Manual

## NetDirector® Rack-Mount Console KVM Switch with IP Access

Models: B030-008-17-IP, B030-DP08-17DIP, B030-DP16-17DIP

### WARRANTY REGISTRATION

Register your product today and be automatically entered to win an ISOBAR® surge protector in our monthly drawing!

[tripplite.com/warranty](https://www.tripplite.com/warranty)



1111 W. 35th Street, Chicago, IL 60609 USA • [tripplite.com/support](https://www.tripplite.com/support)

Copyright © 2022 Tripp Lite. All rights reserved.

# Table of Contents

<b>1. FCC Information</b>	<b>4</b>	<b>11. KVM Web Interface</b>	<b>32</b>
<b>2. User Notice</b>	<b>4</b>	<b>11.1 Web Interface Main Page</b>	<b>32</b>
<b>3. Package Contents</b>	<b>4</b>	11.1.1 Tab Bar	33
<b>4. Features</b>	<b>5</b>	<b>11.2 Port Access</b>	<b>33</b>
<b>5. System Requirements</b>	<b>6</b>	11.2.1 Connections	33
5.1 Built-in LCD Console	6	11.2.2 Port Selection List	35
5.2 Optional External Console	6	11.2.3 Port Naming	35
5.3 Computers	6	<b>11.3 Web Interface Icons and Controls</b>	<b>36</b>
5.4 Operating Systems	6	<b>11.4 Interactive Display Panel</b>	<b>36</b>
5.5 Components	6	11.4.1 Device Level	36
<b>6. Important Safety Instructions</b>	<b>8</b>	11.4.2 Port Level	37
6.1 General Safety Instructions	8	<b>11.5 History</b>	<b>37</b>
6.2 Rack-Mounting Safety Instructions	9	<b>11.6 Favorites</b>	<b>38</b>
<b>7. Installation</b>	<b>10</b>	<b>11.7 User Preferences</b>	<b>40</b>
7.1 Standard Rack Mounting	10	<b>11.8 Sessions</b>	<b>41</b>
7.2 2-Post Rack Mounting	10	<b>11.9 Access</b>	<b>41</b>
7.3 Grounding	10	<b>11.10 Port Configuration</b>	<b>42</b>
7.4 KVM Switch Installation	10	<b>11.11 Associated Link</b>	<b>44</b>
7.5 Opening/Closing the Console	11	<b>11.12 User Management</b>	<b>44</b>
7.5.1 Opening Separately	11	11.12.1 Device Assignment	47
7.5.2 Opening Together	12	11.12.2 Device Management	47
7.5.3 Opening Precautions	13	11.12.3 Device Information	48
7.5.4 Closing the Console	14	<b>11.13 Operating Mode</b>	<b>49</b>
7.6 Network Setup – IP Address Configuration	16	<b>12. Network Settings</b>	<b>50</b>
7.6.1 Local Console	16	<b>12.1 Advanced Network Management Settings (ANMS)</b>	<b>52</b>
7.6.2 IP Installer	17	12.1.1 RADIUS Settings	54
7.6.3 Browser	17	12.1.2 Configuring RADIUS Authentication	54
<b>8. Basic Operation</b>	<b>19</b>	<b>12.2 LDAP / LDAPS Authentication and Authorization Settings</b>	<b>62</b>
8.1 LCD OSD Configuration	19	12.2.1 LDAP Configuration — Active Directory	62
8.1.1 LCD Buttons	19	12.2.2 Extend and Update the Active Directory Schema	63
8.1.2 Adjustment Settings	19	<b>12.3 OpenLDAP Server Installation</b>	<b>68</b>
8.1.3 Hot Plugging	19	12.3.1 OpenLDAP Server Configuration	68
8.1.4 Powering Off and Restarting	19	12.3.2 Starting the OpenLDAP Server	69
8.1.5 USB Peripheral Devices	19	12.3.3 Customizing the OpenLDAP Schema	70
<b>9. KVM Operation</b>	<b>20</b>	<b>12.4 LDAP DIT Design and LDIF File</b>	<b>70</b>
9.1 Local Console	20	12.4.1 LDAP Data Structure	70
9.1.1 Local Console Login	20	12.4.2 DIT Creation	71
9.1.2 Local Console OSD Hotkey Sequence	20	12.4.3 Using the New Schema	72
9.1.3 OSD Main Menu	20	<b>13. Security</b>	<b>73</b>
9.1.4 OSD Navigation	21	<b>13.1 Login Failures</b>	<b>73</b>
9.1.5 OSD Functions	21	<b>13.2 Filtering</b>	<b>73</b>
<b>10. Logging In to the KVM over IP</b>	<b>28</b>	13.2.1 IP Filtering	74
10.1 Web Browser	28	<b>13.3 Login String</b>	<b>74</b>
10.2 AP Windows Client Login	28	<b>13.4 MAC Filtering</b>	<b>75</b>
10.3 AP Java Client Login	31	<b>13.5 Account Policy</b>	<b>75</b>
		<b>13.6 Mode</b>	<b>76</b>
		<b>13.7 Private Certificate</b>	<b>76</b>
		<b>14. Date/Time</b>	<b>77</b>
		14.1 Time Zone	77
		14.2 Network Time	77
		<b>15. Log</b>	<b>78</b>

# Table of Contents

<b>16. Maintenance</b> .....	<b>80</b>	<b>19. Auto Scan Mode</b> .....	<b>100</b>
<b>16.1 Upgrade Main Firmware</b> .....	<b>80</b>	<b>19.1 Setting the Scan Interval</b> .....	<b>100</b>
16.1.1 Main Firmware Upgrade Recovery.....	80	<b>19.2 Initiating Auto Scan</b> .....	<b>100</b>
<b>16.2 Update Display Info</b> .....	<b>81</b>	<b>19.3 Pausing Auto Scan</b> .....	<b>100</b>
<b>16.3 Backup/Restore</b> .....	<b>81</b>	<b>19.4 Exiting Auto Scan</b> .....	<b>100</b>
<b>16.4 Ping</b> .....	<b>82</b>	<b>20. Appendix</b> .....	<b>101</b>
<b>16.5 System Operation</b> .....	<b>83</b>	<b>20.1 Keyboard Emulation</b> .....	<b>101</b>
<b>16.6 Download</b> .....	<b>83</b>	20.1.1 Mac Keyboard.....	101
<b>17. Log Server</b> .....	<b>84</b>	20.1.2 Sun Keyboard .....	101
<b>17.1 Installation</b> .....	<b>84</b>	<b>20.2 Troubleshooting</b> .....	<b>102</b>
<b>17.2 Opening the Log Server</b> .....	<b>84</b>	20.2.1 General Operation .....	102
<b>17.3 Menu Bar</b> .....	<b>84</b>	20.2.2 Administration.....	103
17.3.1 Configure.....	85	20.2.3 Mouse .....	103
17.3.2 Edit.....	85	20.2.4 AP Windows Client.....	103
17.3.3 Delete.....	85	20.2.5 WinClient ActiveX Viewer .....	104
<b>17.4 Events</b> .....	<b>86</b>	20.2.6 Panel Array Mode .....	104
17.4.1 Search .....	86	20.2.7 Java Applet and AP Java Client.....	104
<b>17.5 Maintenance</b> .....	<b>87</b>	20.2.8 Log Server .....	105
<b>17.6 Options</b> .....	<b>87</b>	20.2.9 Sun Systems .....	105
17.6.1 Network Retry .....	87	<b>20.3 Specifications</b> .....	<b>106</b>
<b>17.7 Help</b> .....	<b>87</b>	<b>20.4 OSD Factory Default Settings</b> .....	<b>106</b>
17.7.1 Contents .....	87	<b>21. Warranty and Product Registration</b> .....	<b>107</b>
17.7.2 About Log Server.....	87		
<b>17.8 Log Server Main Screen</b> .....	<b>88</b>		
<b>18. Remote Session Operation</b> .....	<b>89</b>		
<b>18.1 Control Panel</b> .....	<b>90</b>		
<b>18.2 Remote Session Toolbar</b> .....	<b>97</b>		
18.2.1 Remote Session Toolbar Icons .....	97		
18.2.2 Remote Session Toolbar Hotkeys.....	98		
<b>18.3 Panel Array Mode</b> .....	<b>98</b>		
18.3.1 Panel Array Toolbar Icons.....	99		

## 1. FCC Information

This device complies with part 15 of the FCC Rules. Operation is subject to the following two conditions: (1) This device may not cause harmful interference, and (2) this device must accept any interference received, including interference that may cause undesired operation.

**Note:** This equipment has been tested and found to comply with the limits for a Class A digital device, pursuant to part 15 of the FCC Rules. These limits are designed to provide reasonable protection against harmful interference when the equipment is operated in a commercial environment. This equipment generates, uses, and can radiate radio frequency energy and, if not installed and used in accordance with the instruction manual, may cause harmful interference to radio communications. Operation of this equipment in a residential area is likely to cause harmful interference in which case the user will be required to correct the interference at his own expense. The user must use shielded cables and connectors with this equipment. Any changes or modifications to this equipment not expressly approved by Tripp Lite could void the user's authority to operate this equipment.

## 2. User Notice

All information, documentation, and specifications contained in this manual are subject to change without prior notification by the manufacturer. The manufacturer makes no representations or warranties, either expressed or implied, with respect to the contents hereof and specifically disclaims any warranties as to merchantability or fitness for any particular purpose. Any of the manufacturer's software described in this manual is sold or licensed "as is." Should the programs prove defective following their purchase, the buyer (and not the manufacturer, its distributor, or its dealer), assumes the entire cost of all necessary servicing, repair and any incidental or consequential damages resulting from any defect in the software.

The manufacturer of this system is not responsible for any radio and/or TV interference caused by unauthorized modifications to this device. It is the responsibility of the user to correct such interference.

The manufacturer is not responsible for any damage incurred in the operation of this system if the correct operational voltage setting was not selected prior to operation. **VERIFY THAT THE VOLTAGE SETTING IS CORRECT BEFORE USE.**

## 3. Package Contents

- NetDirector B030-Series Rack-Mount Console KVM Switch with IP Access
- (x2) High-Speed HDMI Cables - 6 ft., or (x2) DisplayPort Cables - 6 ft. (depending on model purchased)
- (x2) USB 2.0 A/B Cables – 6 ft.
- IEC C13 to NEMA 5-15P Power Cord
- Grounding Wire
- Quick Start Guide
- CD with Owner's Manual

Check to ensure all components are present and in good order. If anything is missing, or was damaged in shipping, contact your dealer.

Read this manual thoroughly and follow the installation and operation procedures carefully to prevent any damage to the switch or to any other devices on the installation.

### Optional Accessories

- N201-Series Cat6 Gigabit Snagless Patch Cables
- P006-Series IEC C13 to NEMA 5-15P Power Cords
- P580-Series DisplayPort Cables with Latches (M/M)
- P569-Series High-Speed HDMI Cables, 4K, (M/M)
- P782-XXX-DH\* HDMI/DVI + USB KVM Cable Kits (for model B030-008-17-IP only)

\*XXX refers to the length, with cables available in 6 ft. (006), 10 ft. (010) and 15 ft. (015) lengths

## 4. Features

- Rack-Mount Console KVM Switch with built-in IP Access in a dual-rail housing with top and bottom clearance for integrated operation in 1U of rack space.
- KVM console combines a 17.3" LCD monitor, keyboard, and touchpad.
- Model B030-008-17-IP: connect an external DVI monitor or computer using HDMI to DVI adapter cables.
- Models B030-DP08-17DIP / B030-DP16-17DIP: connect an external DisplayPort monitor using DisplayPort cables.
- Multi-platform support; compatible with Windows®, Mac®, Linux® and Sun.
- Dual-Rail – LCD Monitor module can slide independently of the keyboard/touchpad module.
- A single console controls up to 8 or 16 computers.
- Remotely access computers via LAN, WAN, or the internet – control your installation when and where you want.
- 10/100/1000 network port.
- Grayscale option to improve transfer speed in low bandwidth situations.
- User-selectable network transfer rate.
- Optional external console ports located on the rear of the device – manage computers in the LCD KVM switch from an external console (monitor, USB keyboard, USB mouse).
- Features a USB 1.1 hub port on the front of the console for the connection of a USB peripheral device such as a flash drive or external mouse.
- Console lock – enables the console modules to remain securely locked away in position when not in use.
- Browser-based User Interface supported
- Browser access can be disabled – AP Windows and Java Clients are available for non-browser IP access to the KVM.
- Graphical OSD and graphical toolbars for convenient, user-friendly operation.
- Up to 64 user accounts – up to 32 concurrent remote logins.
- Message board feature allows logged-in users to communicate with one another and a remote user to take exclusive control of the KVM functions.
- Panel Array Mode – view all ports at the same time in a grid format.
- Broadcast Mode support – Keyboard commands can be broadcast to all available computers in the installation.
- Three user account types: Super Administrator, Administrator, and User.
- Supports SSL 128-bit data encryption and RSA 1024-bit certificates to secure user browser logins.
- Flexible encryption design allows users to choose any combination of 56-bit DES, 168-bit 3DES, 256-bit AES, 128-bit RC4, or Random for independent KB/Mouse, video and virtual media data encryption.
- Remote authentication support: RADIUS, LDAP, LDAPS and MS Active Directory.
- Flash firmware upgradable over a network connection.
- Ports can be set to Exclusive, Occupy and Share.
- Network Interfaces: TCP/IP, HTTP, HTTPS, UDP, RADIUS, DHCP, SSL, ARP, DNS, 10Base-T/100Base-TX, Auto Sense, and Ping.
- Supports video resolutions up to 1920 x 1080 @ 60 Hz.
- DDC emulation – video settings of attached computers are automatically adjusted for optimal output to the monitor.
- HDCP support (local monitor and external console port only).
- Includes an advanced FPGA graphics processor for improved video quality.
- UltraSync for USB mice ensures local and remote mouse movement are the same, eliminating the need to constantly re-sync the two movements.
- Both IPv4 and IPv6 are supported.
- BIOS level access.
- Includes Automated Certificate Signing Request (CSR) creation utility and third party CA certificate authentication.
- Multi-language support; remote onscreen diagnostics can be displayed in English, Spanish, French, German, Russian, Italian, Japanese, Korean, traditional Chinese and simplified Chinese.
- Remote access interface on-screen keyboard offers multi-language support.
- Supports exit Macros.
- Windows-based log server.

## 5. System Requirements

### 5.1 Built-in LCD Console

The integrated LCD monitor's maximum resolution is 1920 x 1080 @60 Hz. Ensure all resolution settings of the connected computers do not exceed the LCD monitor's maximum resolution.

### 5.2 Optional External Console

- Model B030-008-17-IP: A DVI (user-supplied adapter required) or HDMI monitor capable of displaying the highest resolutions provided by any computer in the installation.
- Models B030-DPXX-17DIP: A DisplayPort monitor capable of displaying the highest resolutions provided by any computer in the installation.
- USB keyboard and mouse.

### 5.3 Computers

The following equipment must be installed on each computer:

- A DVI, HDMI or DisplayPort video graphics card.
- USB mouse and keyboard ports.

### 5.4 Operating Systems

OS	Supported Versions
Windows	NT and higher
Mac	OS 9.0 and higher
Linux RedHat	9.0 and higher
Linux SuSE	10 and higher
Linux Mandriva (Mandrake)	9.0 and higher
UNIX AIX	4.3 and higher
UNIX FreeBSD	5.5 and higher
UNIX Sun	Solaris 8 and higher
Novell Netware	5.0 and higher
DOS	6.2 and higher

### 5.5 Components

Front View

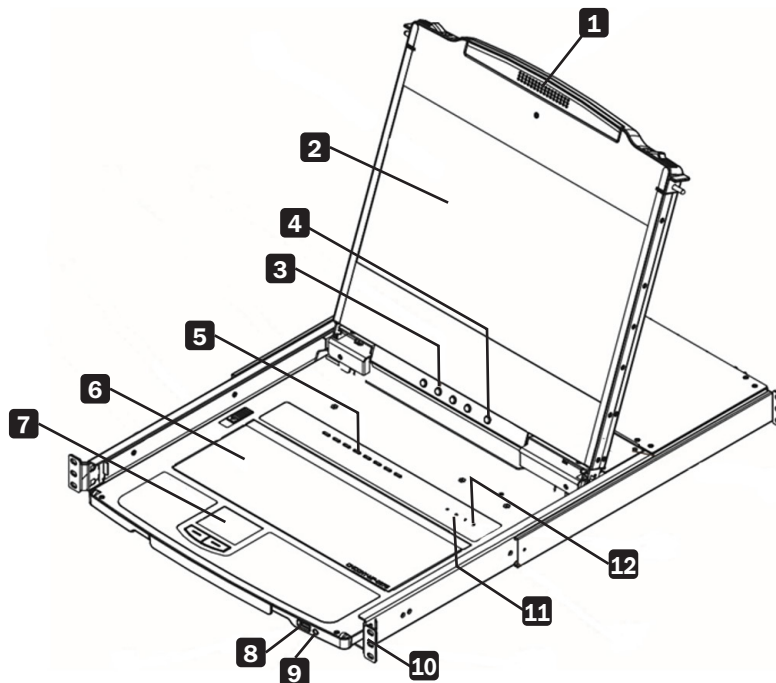

## 5. System Requirements

No.	Component	Description
1	Handle	Pull to slide the KVM module out; push to slide it in.
2	LCD Module	After sliding out the KVM module, flip up the cover to access the LCD monitor.
3	LCD Controls	The buttons to control the position and picture settings of the LCD monitor are located here.
4	LCD On / Off Button	Push this button to turn the LCD monitor on and off. The button illuminates when the LCD monitor is off. <b>Note:</b> The light indicates that only the monitor is off, not the attached KVM switch.
5	Port Selection Buttons and LED	To access a port, press its corresponding selection button. Indicator LEDs are built into the switches, with an Online LED to indicate that the computer attached to its corresponding port is up and running, and a Selection LED light to indicate which port has the KVM focus. <ul style="list-style-type: none"> <li>• Press buttons 1 and 2 at the same time for 5 seconds to perform a keyboard/mouse reset.</li> <li>• Press buttons 7 and 8 at the same time for 2 seconds to initiate an Auto Scan.</li> </ul>
6	Keyboard Module	Standard 99-key keyboard.
7	Touchpad	Standard mouse touchpad.
8	USB Port	The USB 1.1 hub port connects a USB peripheral device (flash drive, CD-ROM drive, etc.) to the console or a USB mouse for users who prefer to use an external mouse.
9	Power LED	Illuminates blue to indicate the device is receiving power.
10	Rack Mounting Tabs	Rack mounting tabs are located at each corner of the device.
11	Lock LEDs	The Num Lock, Caps Lock, Scroll Lock LEDs are located here.
12	Reset Switch	Located to the right of the Lock LEDs. Press this recessed switch using a thin object to perform a system reset.

### Rear View

**Note:** B030-008-17-IP is shown below. B030-DP08-17DIP is identical, except the video input port 3 is DisplayPort. B030-DP16-17DIP is identical, except the video input port 3 is DisplayPort and there are 16 ports 4.

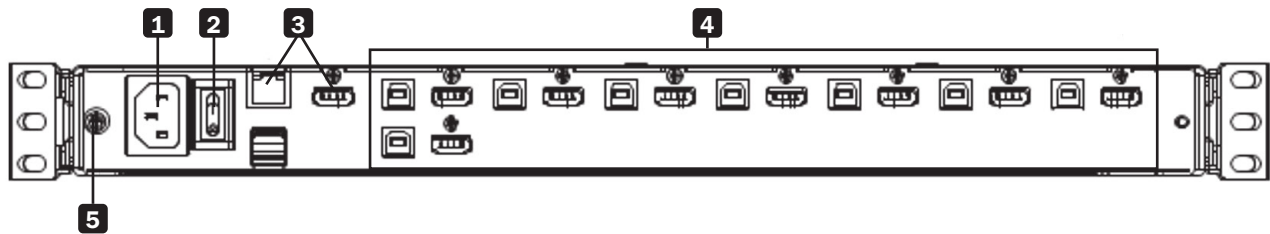

No.	Component	Description
1	Power Socket	This is a standard 3 prong C14 AC power connector. The power cord from an AC source plugs in here.
2	Power Switch	This is a standard rocker switch that powers the device on and off.
3	External Console Section	Supports an independent, external KVM console for flexibility and convenience. The external console's USB keyboard and mouse, monitor and audio cables plug in here.
4	KVM Port Section	Connects the device's ports to computers/servers using HDMI/DisplayPort and USB cables. (see <b>Optional Accessories</b> in section 3 for the KVM cable kit model)
5	Grounding Terminal	The included grounding wire attaches here.

## 6. Important Safety Instructions

### 6.1 General Safety Instructions

- Read all of these instructions and save them for future reference.
- Follow all warnings and instructions marked on the device.
- Do not place the device on any unstable surface. If the device falls, serious damage will result.
- Do not use the device near water.
- Do not place the device near or over, radiators or heat registers.
- The device cabinet is provided with slots and openings to allow for adequate ventilation. To ensure reliable operation and protect against overheating, these openings should never be blocked or covered.
- The device should never be placed on a soft surface such as a bed, sofa or rug. Doing so will block the device's ventilation openings. Moreover, the device should not be placed in a built-in enclosure unless adequate ventilation has been provided.
- Never spill liquid of any type on the device.
- Unplug the device from the wall outlet before cleaning. Use a damp cloth for cleaning. Do not use liquid or aerosol cleaners.
- The device should be operated from the power source indicated on the marking label. If uncertain of the power available, consult your dealer or local power company.
- The device is designed for IT power distribution systems up to 230V phase-to-phase voltage.
- As an added safety feature, the device is equipped with a 3-wire grounding type plug. If unable to insert the plug into the outlet, contact an electrician to replace the obsolete outlet. Do not attempt to plug into a two-prong ungrounded outlet. Always follow local/national wiring codes.
- Do not allow anything to rest on the power cord or cables. Route the power cord and cables to avoid them being stepped on or tripped over.
- If an extension cord is used with this device, ensure the total ampere ratings of all products used on the extension cord do not exceed its rated ampere rating. Also ensure all products plugged into the wall outlet does not exceed a total of 15 amperes.
- Consideration should be given to the connection of equipment and the supply circuit, as well as what effect overloading the supply circuit might have on overcurrent protection and supply wiring.
- To help protect the system from unexpected transient increases and decreases in electrical power, use a Tripp Lite Surge Protector, Line Conditioner, or Uninterruptible Power Supply (UPS).
- Position system cables and power cables carefully so nothing rests on any cables.
- When connecting or disconnecting power to hot pluggable power supplies, observe the following guidelines:
  - Install the power supply before connecting the power cable to the power supply.
  - Unplug the power cable before removing the power supply.
  - If the system has multiple sources of power, disconnect power from the system by unplugging all power cables from the power supplies.
- Never push objects of any kind into or through cabinet slots. They may touch dangerous voltage points or short out parts resulting in a risk of fire or electrical shock.
- Do not attempt to service the device; refer all servicing to qualified service personnel.
- If the following conditions occur, unplug the device from the wall outlet and bring it to qualified service personnel for repair:
  - The power cord or plug has become damaged or frayed.
  - Liquid has been spilled into the device.
  - The device has been exposed to rain or water.
  - The device has been dropped, or the cabinet has been damaged.
  - The device exhibits a distinct change in performance, indicating a need for service.
  - The device does not operate normally when the operating instructions are followed.
- Only adjust controls covered in the operating instructions. Improper adjustment of other controls may result in damage that will require extensive work by a qualified technician to repair.
- Use of this equipment in life support applications where failure of this equipment can reasonably be expected to cause the failure of the life support equipment or to significantly affect its safety or effectiveness is not recommended. Do not use this equipment in the presence of a flammable anesthetic mixture with air, oxygen or nitrous oxide.



## 6. Important Safety Instructions

### 6.2 Rack-Mounting Safety Instructions

- The ambient operating temperature in the rack may be an issue and is dependent upon the rack load and ventilation. When installing in a closed or multi-device rack assembly, ensure the temperature will not exceed the maximum rated ambient temperature.
- Before installing the rack, ensure the stabilizers are secured to the rack, extended to the floor and the full weight of the rack rests on the floor. Install front and side stabilizers on a single rack or front stabilizers for joined multiple racks before working on the rack.
- Always load the rack from the bottom up with the heaviest item loaded into the rack first.
- When loading the rack, avoid creating a hazardous condition due to uneven loading.
- Ensure the rack is level and stable before extending a device from the rack.
- Use caution when pressing the rail release latches or sliding a device into or out of a rack; slide rails can pinch your fingers.
- After a device is inserted into the rack, carefully extend the rail into a locking position, then slide the device into the rack.
- Do not overload the AC supply branch circuit that provides power to the rack. The total rack load should not exceed 80 percent of the branch circuit rating.
- Ensure that proper airflow is provided to devices in the rack.
- Do not step on or stand on any device when servicing other devices in a rack.
- Do not connect the RJ11 connector marked “Upgrade” to a public telecommunication network.
- **Caution!** Slide/Rail (LCD KVM) mounted equipment is not to be used as a shelf or work space.



**CAUTION!**  
Slide/rail-mounted  
equipment is not to be  
used as a shelf  
or a workspace.

## 7. Installation

The Console KVM Switch is designed for mounting in a 1U rack system. A rack-mounting kit is included for quick installation. The various mounting options are explained in the following subsections. The installation instructions depict model B030-008-17-IP, but all steps are the same for all models.

### 7.1 Standard Rack Mounting

The standard rack mounting brackets that come attached to the console KVM switch allow the device to be installed in a standard 1U rack by a single individual.

1. Slide out the rear mounting brackets from the console and mount both brackets (separate from the console) to the inside rear of a standard 1U rack system using user-supplied screws.
2. Gently slide the console into the two rear-mounted brackets in the rack and secure the console in place with user-supplied screws.

### 7.2 2-Post Rack Mounting

The console KVM switch can also be mounted in a 2-post rack installation using the optional 2-Post Rack Mount Kit (model #: B019-000). The mounting hardware allows for the console to be opened with the drawer in any position. Heavy-duty 14-gauge steel provides stability and prevents the console frame from twisting. See the B019-000 instructional manual for detailed mounting instructions.

### 7.3 Grounding

To prevent damage to the installation, it is important that all devices are properly grounded. Use the included green-yellow ground wire (min. 0.5 mm<sup>2</sup>, min. 20 AWG) to ground the KVM switch by connecting one end of the wire to the grounding terminal on the device and the other end of the wire to a suitable grounded cabinet.

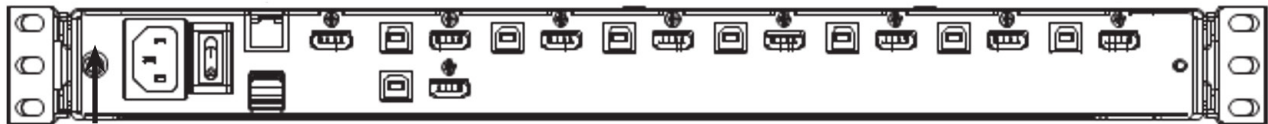

### 7.4 KVM Switch Installation

To set up the console KVM switch, refer to the following steps and installation diagram.

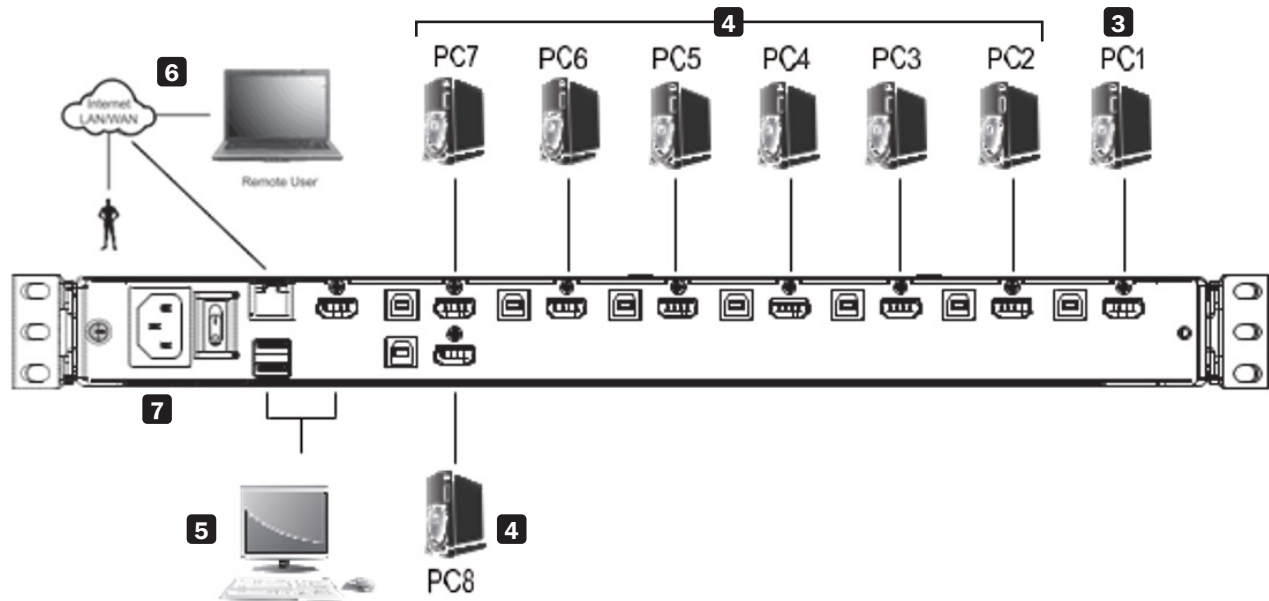

- 1 Power off all computers that will connect to the KVM switch.
- 2 Connect a USB cable from a USB CPU port on the KVM to the USB port on a computer.
- 3 Connect the HDMI CPU port on the KVM to the HDMI or DVI\* port on a computer.
- 4 Repeat steps 2 and 3 for each additional computer you are connecting to the KVM.

## 7. Installation

- 5 (Optional)** Add an external console to the KVM by connecting an HDMI or DVI\* monitor and USB keyboard and mouse to the console ports on the back of the device.
- 6** Connect the LAN port on the back of the device to the network using Cat5e/6 cable.
- 7** Plug the included power cord into a Tripp Lite Surge Protector, Power Distribution Device (PDU), Uninterruptible Power Supply (UPS) or AC wall outlet.
- 8** Power the connected computers.
- 9** Power the KVM device.

\*Using an HDMI to DVI adapter cable, such as Tripp Lite's P566-Series cables.

### 7.5 Opening / Closing the Console

The console consists of two modules: an LCD module located under the top cover and a keyboard / touchpad module below the LCD module. The modules can slide together or independently of one another. This allows the LCD to be available for viewing while the keyboard / touchpad module is not in use.

#### 7.5.1 Opening Separately

1. Release the console by sliding the front panel toward the center. Then engage the catches and pull the top panel 1-2 inches toward you. Once the console has been released, release the catches.

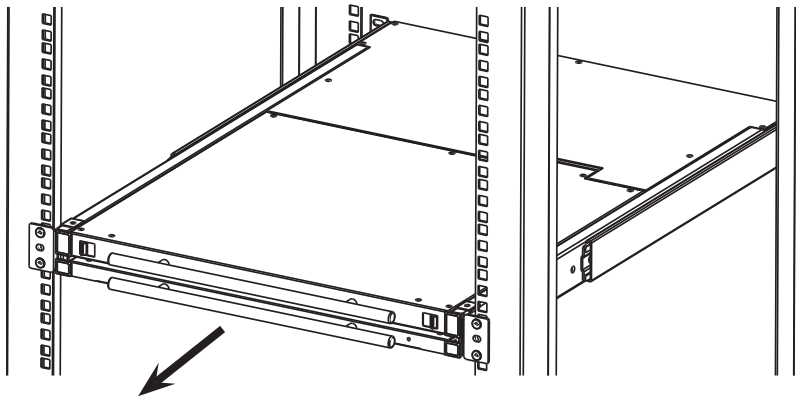

2. Pull the top panel all the way out until it clicks into place.

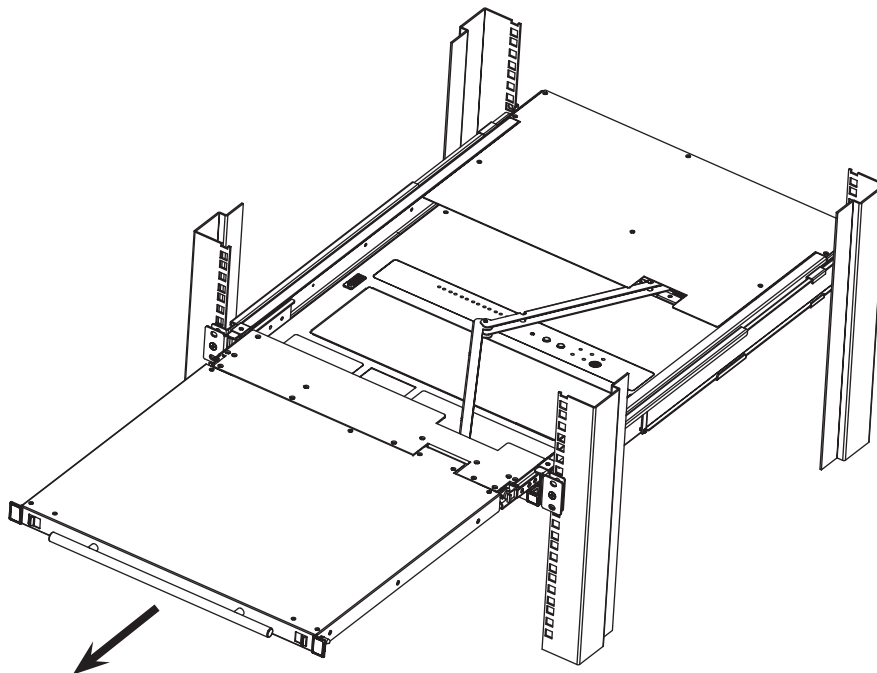

## 7. Installation

3. Rotate the top panel all the way back to expose the LCD screen.

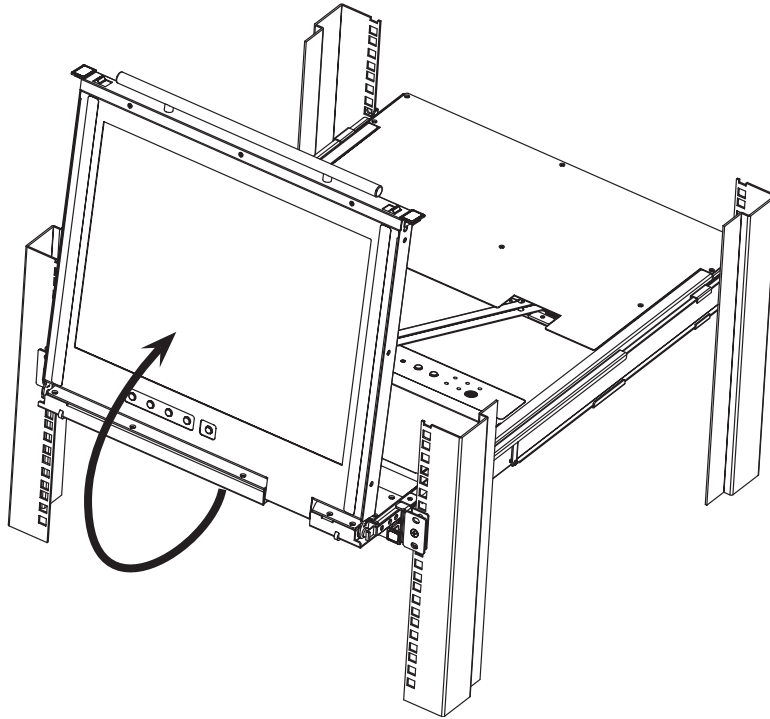

4. Reach underneath and pull out the keyboard module until it clicks into place.

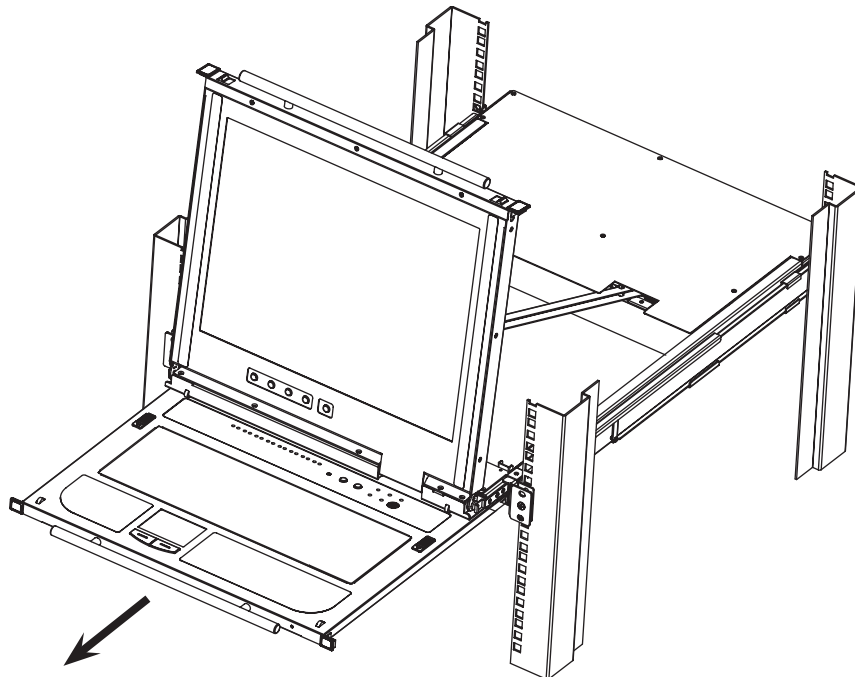

### 7.5.2 Opening Together

Refer to the diagrams in the Opening Separately section as you do the following:

1. Engage the release catches and pull the top and bottom panels out until the keyboard module clicks into place. Once the console has been released, release the catches.
2. Pull the top panel out until it clicks into place.
3. Rotate the top panel all the way back to expose the LCD screen.

## 7. Installation

### 7.5.3 Opening Precautions

The maximum load bearing capacity of the keyboard module is 65 lb. Failure to heed the instructions below can result in damage to the keyboard module.

#### ***CORRECT***

Rest your hands and arms lightly on the keyboard module as you work.

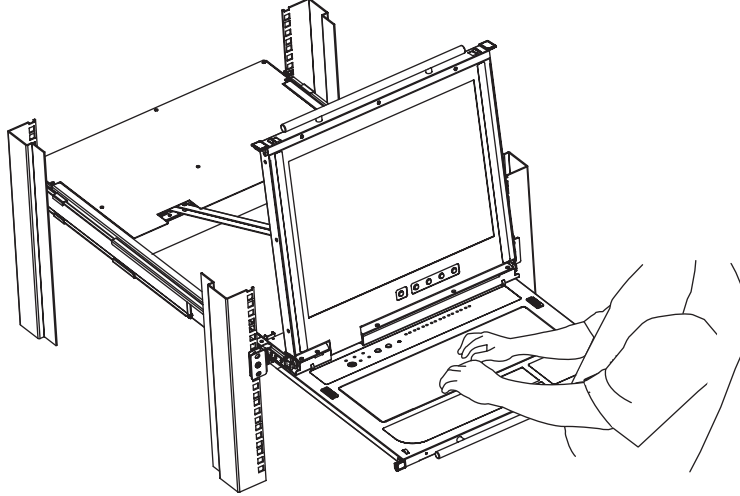

#### ***INCORRECT!***

- DO NOT apply body weight on the keyboard module.
- DO NOT place heavy objects on the keyboard module.

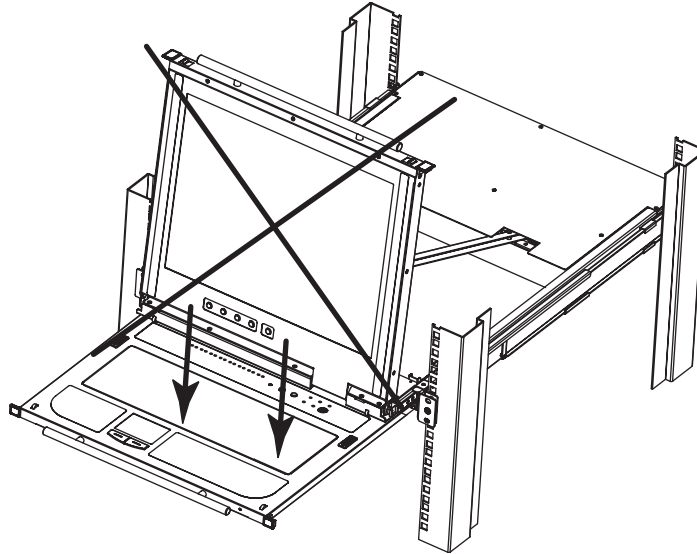

## 7. Installation

### 7.5.4 Closing the Console

1. Engage the release catches located on either side of the keyboard to release the keyboard module, then slide in the module slightly.

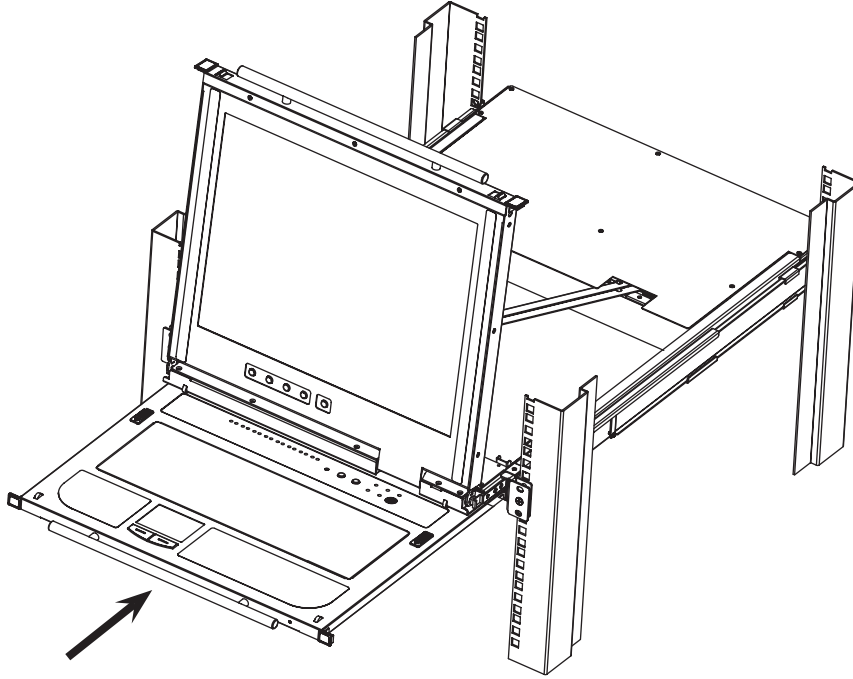

2. Release the catches. Using the front handle, push the keyboard module all the way in.

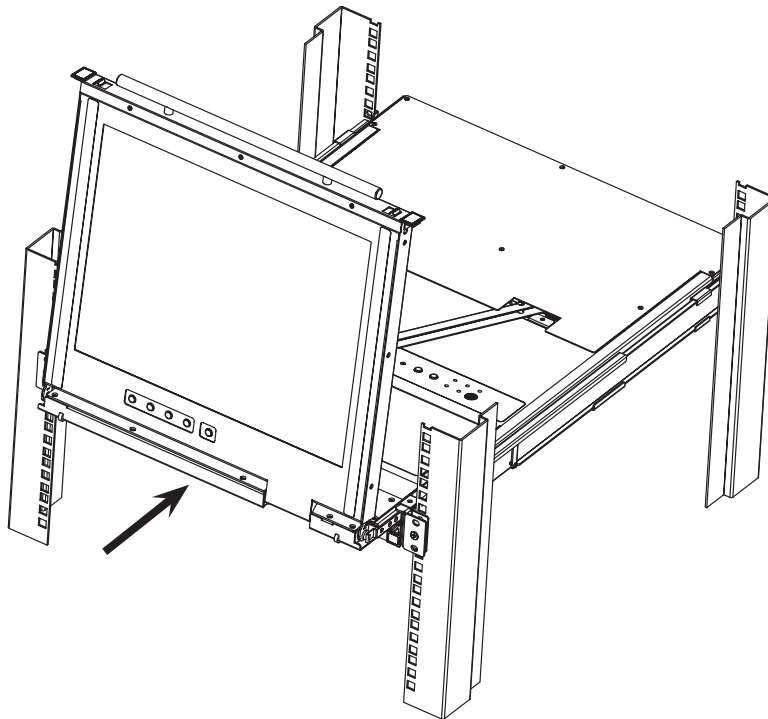

## 7. Installation

3. Rotate the LCD module all the way down, then engage the rear catches to release the LCD module.

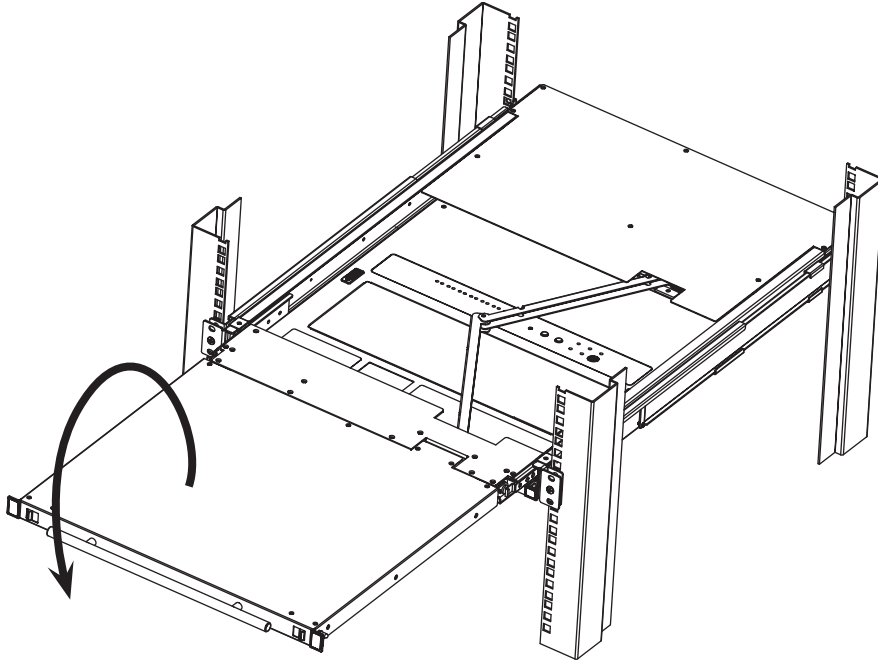

4. Using the front handle, push the module all the way in.

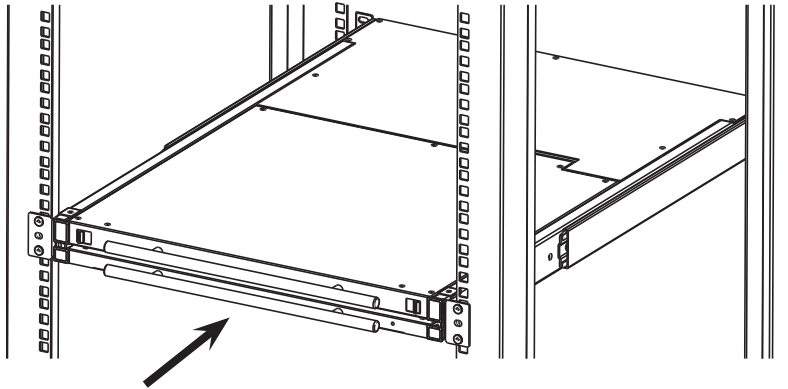

# 7. Installation

## 7.6 Network Setup – IP Address Configuration

By default, the KVM will automatically have an IP address assigned via DHCP server. To configure a fixed IP address, you will need to access the KVM switch in one of three ways: Local Console, IP Installer or Browser.

### 7.6.1 Local Console

**Note:** The local console OSD only allows IPv4 network settings configuration. For IPv6, access the Web Management Interface.

1. When accessing the console KVM switch for the first time, a prompt will appear asking for a username and password. The default Username is **administrator**, and the default Password is **password**. For security purposes, changing the username and password is strongly recommended. Once the default username and password are entered, the OSD Main page will appear.
2. Press the [F4] key to open the OSD ADM page.
3. In the OSD ADM page, highlight SET IP ADDRESS and press [Enter]. The following screen appears.



4. By default, the *Obtain an IP address automatically (DHCP)* option is selected. To manually assign an IP address, check the radio button next to the *Use the following IP address* option.
5. You can then navigate to the *IP Address*, *Subnet Mask* and *Default Gateway* fields by entering the settings suitable for your network. Upon changing the KVM's IP Address settings, the Reset on Exit function of the F4: ADM menu will be automatically activated. Upon logging out, the new settings will be saved for use going forward. If you go into the F4: ADM menu and clear the Reset on Exit check mark before logging out, the changed settings will be ignored and the original IP Address settings will remain in effect.

**Note:** Although the changed IP settings are ignored, they still remain in the network settings fields. The next time a page is opened, the Reset on Exit box will automatically be enabled. When the switch resets, the new IP settings will become the ones used by the switch. To avoid this problem, go back to the network settings page and ensure the desired IP settings appear in the fields.



# 7. Installation

## 7.6.2 IP Installer

Computers running Windows can use the IP Installer utility found in the included CD-ROM to assign an IP address to the KVM.

**Notes:**

- The IP Installer Settings section located in the KVM's Web Management Interface network page must be enabled in order to use the IP Installer to assign an IP address. This setting is enabled by default.
- The local console OSD only configures IPv4 network settings. For IPv6, access the Web Management Interface.

1. Save the IP Installer.exe file from the CD to a desired location on a computer that is on the same network as the KVM switch.
2. Locate the recently saved IP Installer.exe file and double-click on its icon. A screen similar to the one below will appear.

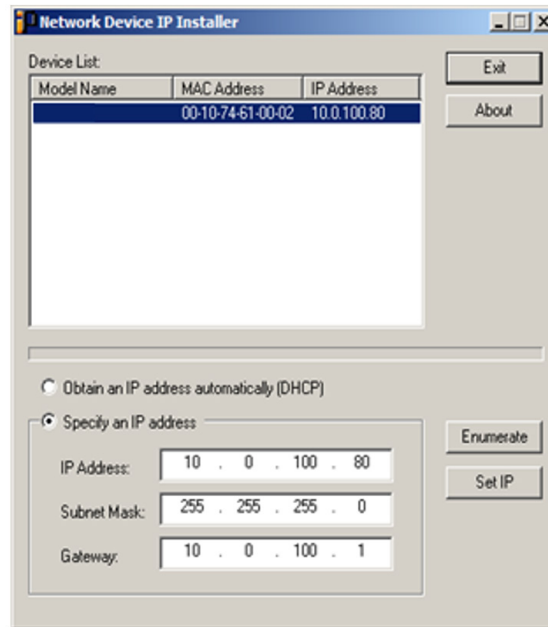

3. The IP Installer searches the network and displays all B030-008-17-IP switches found in the device list. If your device does not appear in the list, click the **Enumerate** button to refresh the device list. If more than one of the same KVM switch models appears in the list, locate the desired device using the MAC address found on the bottom of the console KVM. Once your device is located in the list, highlight it.
4. From here you can choose between the following two options: 1. Obtain an IP address automatically (DHCP), or 2. Specify an IP address. If you choose to assign your own address, fill in the IP Address, Subnet Mask, and Gateway fields with information appropriate to your network. Click on the **Set IP** button to apply the new network settings to the selected KVM switch.
5. After the new IP address shows up in the device list, click the **Exit** button to exit the IP Installer.

## 7.6.3 Browser

By default, the KVM switch will have an IP Address automatically assigned via DHCP server. If the KVM Switch is on a network that does not have a DHCP server to automatically assign an IP address, it boots with a default IP address. The default IPv4 and IPv6 addresses can be found on the sticker located on the bottom of the KVM.

1. For a computer/server on the same network as your console KVM switch, set the computer/server's IP address to 192.168.0.XXX, where XXX represents any number or numbers **except** the KVM's default address.
2. Using this computer/server, access the KVM switch via the default address. A screen will appear asking to provide a username and password.

**Note:** If first prompted by a screen stating the website's security certificate cannot be trusted, click on the link to proceed anyway; the certificate can be trusted.

## 7. Installation

- If accessing the KVM for the first time, enter the username **administrator** and the password **password**. For security purposes, changing the username and password is strongly recommended. Once the default username and password are entered, the web management interface will appear with the following page displayed:



- Click on the **Device Management** icon at the top of the page, then click on the **Network** tab. The Network page will appear.

The screenshot shows the Network configuration page in the KVM web management interface. The page is titled 'IP Installer' and has a 'View Only' button. The configuration is divided into several sections:

- Service Ports:** Program: 9000, HTTP: 80, HTTPS: 443.
- IPv4 Settings:** IP Address:  Obtain IP address automatically [DHCP],  Set IP address manually [Fixed IP]. Fields for IP Address, Subnet Mask, and Default Gateway are all set to 0.0.0.0. DNS Server:  Obtain DNS server address automatically,  Set DNS server address manually. Fields for Preferred DNS server and Alternate DNS server are all set to 0.0.0.0.
- IPv6 Settings:** IP Address:  Obtain IPv6 address automatically [DHCP],  Set IPv6 address manually [Fixed IP]. Fields for IPv6 Address, Subnet Prefix Length (set to 64), and Default Gateway are empty.
- DNS Server:**  Obtain DNS server address automatically,  Set DNS server address manually. Fields for Preferred DNS server and Alternate DNS server are empty.

At the bottom right of the page, there are 'Save' and 'Close' buttons.

- The KVM switch supports both IPv4 and IPv6 addresses. The Network page can set the IP address manually or be automatically assigned via DHCP server. By default, the IP address is set to be automatically assigned via DHCP server. To manually assign an IP address, check the **Set IP address manually** check box in the IPv4 Settings or IPv6 Settings sections, depending on your network.
- When checked, the IP address and DNS server address fields open up. Enter the desired settings in the fields. Once all IP address and DNS server address information is entered, click the **Save** icon at the bottom of the screen. Upon logging out of the KVM (click the **Logout** icon in the upper-right corner of the screen), the KVM will reset itself and the IP address settings just entered will be implemented.

## 8. Basic Operation

### 8.1 LCD OSD Configuration

#### 8.1.1 LCD Buttons

The LCD OSD configures the LCD. Four buttons are used to perform the configuration, as described in the table below:

Button	Function
MENU	<ul style="list-style-type: none"><li>When the LCD OSD Menu function has not been entered, pressing this button initiates the Menu function and the Main Menu.</li><li>When the LCD OSD Menu function has been entered and has reached a setting choice with the navigation buttons, pressing this button initiates the adjustment screen.</li></ul>
▶ ▲	When navigating through the menus, this button moves the page right or up. When making an adjustment, it increases the value.
◀ ▼	When navigating through the menus, this button moves the page left or down. When making an adjustment, it decreases the value.
EXIT	<ul style="list-style-type: none"><li>When the LCD OSD Menu function has not been entered, pressing this button performs an auto adjustment. An auto adjustment automatically configures all the settings for the LCD to what the OSD considers their optimum values to be.</li><li>When you have entered the LCD OSD Menu function, pressing this button exits the current menu and returns you to the previous menu. Use it to leave an adjustment menu when you are satisfied with the adjustments.</li><li>When at the Main Menu, pressing this button exits the LCD OSD.</li></ul>

#### 8.1.2 Adjustment Settings

LED OSD adjustment settings are described in the table below:

Setting	Explanation
Brightness	Adjusts the background black level of the screen image.
Contrast	Adjusts the foreground white level of the screen image.
Phase	If pixel jitter or horizontal line noise is visible on the display, the LCD may have the wrong phase setting. Adjust the phase setting to eliminate these problems.
Clock	If vertical banding is visible on the display, the LCD may have the wrong clock setting. Adjust the clock setting to eliminate vertical banding.
H-Position	Positions the display area on the LCD panel horizontally (moves the display area left or right).
V-Position	Positions the display area on the LCD panel vertically (moves the display area up or down).
Color Temperature	Adjusts the color quality of the display, such as the warmth value and color balance. The Adjust Color selection contains a submenu to fine tune RGB values.
Language	Selects the OSD display menus' language.
OSD Duration	Sets the amount of time the OSD will display on the screen. If there is no input for the amount of time chosen, the OSD display turns off.
Reset	Resets the adjustments on all menus and submenus to factory default settings. <b>Note:</b> The Language setting does not return to the factory default, but remains at the one it is currently set to.

#### 8.1.3 Hot Plugging

The Console KVM Switch supports hot plugging – components can be removed and added to the computer by unplugging their cables from the ports without the need to shut down the KVM.

#### 8.1.4 Powering Off and Restarting

If it becomes necessary to power off the KVM switch, or if the switch loses power and needs to be restarted, wait 10 seconds before powering it back on. The computers should not be affected by this, but should any of them should fail, simply restart the affected computers.

#### 8.1.5 USB Peripheral Devices

The USB 1.1 port on the keyboard module's front panel can connect a USB peripheral device, such as a flash drive, CD-ROM drive or printer. Any computer connected to the device can access the USB peripheral on a one-by-one basis. When switching from one computer to another, the peripheral device automatically disconnects from the original computer and connects to the newly selected computer.

**Note:** When connecting a flash drive or other type of external storage device, always eject the device prior to switching ports.

# 9. KVM Operation

## 9.1 Local Console

### 9.1.1 Local Console Login

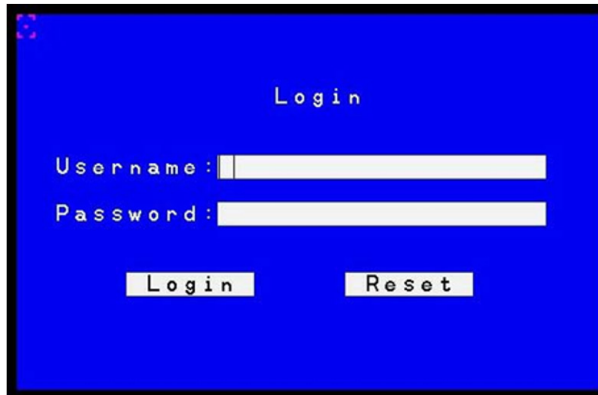

When accessing the console KVM switch for the first time, a prompt will appear asking for a username and password. The default username is **administrator**, and the default password is **password**. For security purposes, changing the username and password on this account is strongly recommended. Once the KVM has been set up and user accounts have been created, the login prompt will appear only when a user logs out of the KVM. After logging in for the first time using the default username and password, the OSD Main Screen will appear in Administrator mode with access to all settings and functions.

### 9.1.2 Local Console OSD Hotkey Sequence

Once logged into the KVM switch and a connected computer, use the local console OSD Hotkey sequence to re-open the OSD Main Menu. The default hotkey sequence is [Scroll Lock, Scroll Lock], but other options include [Ctrl, Ctrl], [Alt] [Alt], [Shift] [Shift] or [Print Screen] [Print Screen].

**Note:** When using the [Scroll Lock, Scroll Lock] OSD Hotkey sequence, hold down the [Fn] key, as the [Scroll Lock] key is part of the [Num Lock] key.

### 9.1.3 OSD Main Menu



<b>1</b>	Connected computers that are powered on and online have a sun symbol in this column.
<b>2</b>	If a port has been given a name, it appears in this column.
<b>3</b>	Click the Power ON box to display only the port information of computers that are both powered on and online.
<b>4</b>	In the Find field, key in the name of a port that you want to find.
<b>5</b>	In the List field, choose to display All computers in the installation or only your Favorites list. <b>Note:</b> The default is All.

## 9. KVM Operation

### 9.1.4 OSD Navigation

- To dismiss the menu and deactivate the OSD, click the **X** in the upper right corner of the OSD window or press [Esc].
- To log out, click the **ZZZ** icon in the upper right corner of the main screen or press [F8].
- To move up or down through the list one line at a time, click the up and down triangle symbols or use the up and down arrow keys. If there are more list entries than appear on the main screen, the screen will scroll.
- To access the computer connected to a port, double-click or move the highlight bar to its location, then press [Enter].
- After executing any action, the cursor will automatically return to the menu one level above.

### 9.1.5 OSD Functions

OSD functions are used to configure and control the OSD. Examples include: rapidly switching to any port, creating a favorites list, creating or editing a port name, or making OSD settings adjustments.

#### To access an OSD function:

1. Click a function key field at the top of the main screen or press a function key on the keyboard.
2. In the submenus, either double-click or move the highlight bar to its location, then press [Enter].
3. Press [Esc] to return to the previous menu level.

#### F1: Help

The only function keys visible on the OSD Main Screen are [F1], [F3], [F4], and [F5]. Using the [F1] HELP function will show other available function keys: [F2], [F7], [F8], [Ctrl]+[T], [Ctrl]+[L], [Ctrl]+[P], [Ctrl]+[F], [Ctrl]+[E], [Ctrl]+[C].



#### F2: Rename Ports Name

To help remember which computer is connected to a particular port, every port can be given a name. This function allows the administrator to create, modify, or delete port names. To edit a port name:

1. Click a port in the list on the OSD Main screen or use the navigation keys to move the highlight bar to its location, then press [F2].
2. Key in the new port name or modify/delete the old one. The maximum number of characters allowed for the port name is 12. Case does not matter; OSD displays the port name in all capitals, no matter how they were keyed in. Legal characters include:
  - All alpha characters: A–Z
  - All numeric characters: 0–9
  - \* ( ) + : - , ? . / and [Space]
3. When finished editing, press [Enter] for the change to take effect. To abort the change, press [Esc].

## 9. KVM Operation

### F3: Set

This function allows the administrator and users to set up their own working environments. A separate profile for each client is stored by the OSD and activated according to the username provided during login. To change a setting:

1. Double-click or move the highlight bar to its location, then press [Enter].
2. After selecting an item, a submenu with additional choices will appear. To make a selection, double-click or move the highlight bar to its location, then press [Enter]. An icon will appear before the selected choice.

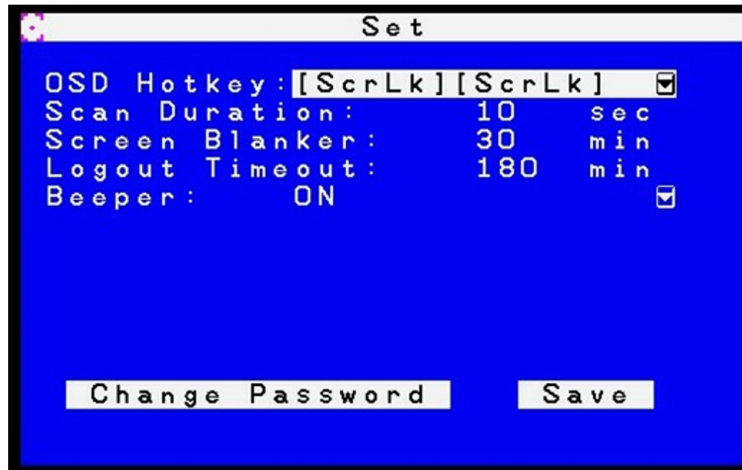

The settings are explained in the following table:

OSD Hotkey	The default setting is [Scroll Lock] [Scroll Lock]. The OSD hotkey can be changed to any of the following combination commands: <ul style="list-style-type: none"> <li>• [Scroll Lock] [Scroll Lock]</li> <li>• [Ctrl] [Ctrl]</li> <li>• [Alt] [Alt]</li> <li>• [Shift] [Shift]</li> <li>• [Print Screen] [Print Screen]</li> </ul>
Scan Duration	Determines how long each port cycles through the selected ports in Auto Scan mode. Key in a value from 1–255 seconds, then press [Enter]. Default is 5 seconds; a setting of 0 disables the SCAN function.
Screen Blanker	If there is no input from the console for the amount of time set here, the screen is blanked. Key in a value from 1–30 minutes, then press [Enter]. The default setting of 0 minutes disables this function.
Logout Timeout	If there is no input from the console for the amount of time set here, the user is automatically logged out. A login is necessary before the console can be accessed again. This enables other users to gain access to the OSD when the original user is no longer accessing them and has forgotten to logout. To set the timeout value, key in a number from 0–180 minutes, then press [Enter]. A setting of 0 disables the Logout Timeout. The default setting is 30 minutes.
Beeper	Options are ON or OFF. When activated, the beeper sounds whenever a port is changed, when activating the Auto Scan function, or when an invalid entry is made in the OSD menu. The default is ON.

## 9. KVM Operation

### F4: ADM

F4 is an administrator-only function. It allows the administrator to configure and control the overall operation of the OSD. To change a setting, double-click or move the highlight bar to its location, then press [Enter].

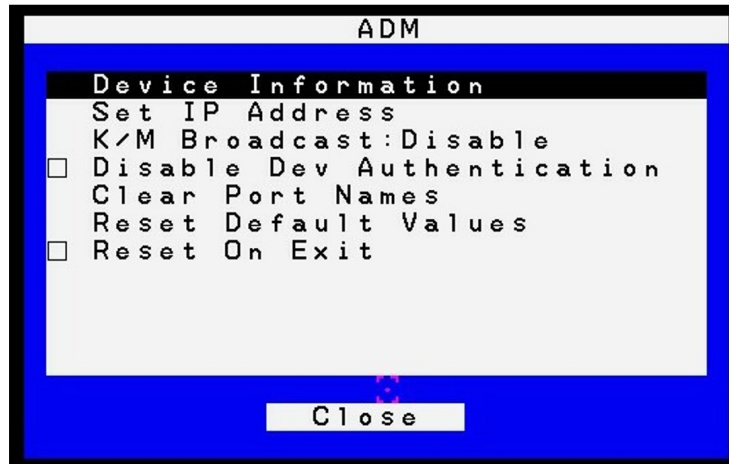

After selecting an item, a submenu with additional choices will appear. Double-click or move the highlight bar to its location, then press [Enter]. An icon will appear before the selected item.

### Device Information

The Device Information page displays the name of the selected device, its firmware version, the FPGA (Field-Programmable-Gate-Array) and information about its network configuration.



## 9. KVM Operation

### Set IP Address

The KVM can have an IP address assigned dynamically (DHCP) or be given a fixed IP address.

- *Obtain an IP address automatically (DHCP)* – This option is selected by default. If the *Use the following IP address* option is selected instead, check the radio button next to the *Obtain an IP address automatically (DHCP)* option to switch.
- *Use the following IP address* – To manually configure the IP address, check the radio button next to the *Use the following IP address* option. Then navigate to the *IP Address*, *Subnet Mask* and *Default Gateway* fields, and enter the settings suitable for your network. Upon changing the IP Address settings of the KVM, the *Reset on Exit* function of the F4: ADM menu will be automatically activated. Upon logging out, the new settings will be saved for future use. By going into the F4: ADM menu and clearing the *Reset on Exit* check mark before logging out, the changed settings will be ignored and the original IP Address settings will remain in effect.

**Note:** Even though the changed IP settings are ignored, they still remain in the network settings fields. In effect, the next time this page is opened, the reset on exit box will automatically be enabled. When the switch resets, the new IP settings that were discarded will be used by the switch. To avoid this problem, go back to the network settings page to ensure the desired IP settings appear in the fields.



### KM Broadcast

Keyboard and Mouse inputs can be sent to all of the connected computers at the same time. This can be useful in situations such as performing a system-wide shutdown, installing or upgrading software, etc. This function is disabled by default.

- If you enable Keyboard Broadcast, your keystrokes will be sent to all connected computers that currently appear in the Sidebar.
- If you enable Mouse Broadcast, your mouse movements and clicks will be sent to all connected computers that currently appear in the Sidebar.

### Disable Dev Authentication

The function disables KVM access by all local user accounts. Users can only login using authentication via RADIUS, LDAP, LDAPS, or MS active Directory.

### Clear Port Names

Use this function to clear all port names.





## 9. KVM Operation

### Reset Default Values

Clicking this button undoes all Customization page changes that have been made to the B030-008-17-IP and returns the parameters to the original factory default settings. The reset values include the following items:

- Security
  - Mode: Enable ICMP, Enable Multiuser Operation, Enable Virtual Media Write Operation, Browser Service
  - Login Failures: Allowed/ Timeout
- Network
  - Network Transfer Rate reset to 99999
- Port Configuration
  - Device Level: Occupy timeout setting
- Operating mode
  - Force All to Grayscale, Enable Client AP device list, Keyboard/Mouse Broadcast, Console Keyboard language
- Port Level
  - Port Properties: Port OS, Access Mode, OS language

### Reset on Exit

The Reset on Exit function resets the KVM upon logout to save changes to the IP Address Settings page. When assigning new IP Address settings, this function will automatically be activated. If you clear the check mark before logging out, the changed settings will be ignored and the original IP Address settings will remain in effect.

**Note:** Even though the changed IP settings are ignored, they still remain in the network settings fields. In effect, the next time this page is opened, the reset on exit box will automatically be enabled. When the switch resets, the new IP settings that were discarded will be used by the switch. To avoid this problem, go back to the network settings page to ensure the desired IP settings appear in the fields.

### F5: SCAN

Clicking on the F5 field at the top of the OSD Main screen or pressing the [F5] key initiates Auto Scan mode. This function automatically switches among the available computers at regular intervals to monitor their activity without the hassle of having to switch manually. To exit Auto Scan mode, press the [Spacebar] or [Esc].

### F7: Close OSD

Clicking the **X** field in the upper-right corner of the OSD Main screen or pressing the [F7] key will exit the OSD display.

### F8: Logout

Clicking the **ZZZ** field in the upper-right corner of the OSD Main screen or pressing [F8] performs a logout of the OSD and clears the console screen. This action differs from simply pressing [Esc] at the main screen to deactivate the OSD; the [F8] key requires logging in again to regain access to the OSD, whereas with [Esc], re-entering the OSD simply requires pressing the OSD hotkey.

#### Notes:

- When re-entering the OSD after logging out, the screen will remain blank except for the OSD main screen. The username and password must be entered before continuing.
- If re-entering the OSD after logging out and immediately using the [Esc] key to deactivate the OSD without having selected a port from the OSD menu, a null port message will display on the screen. The OSD hotkey will open the main OSD screen.

### Ctrl + T: Select Tree List

This function broadens or narrows the number of ports the OSD displays on the main screen.

### Ctrl + L: Select Favorites

Select which favorites to find.

### Ctrl + P: Toggle Powered On

Lists only the ports with connected computers powered on.

### Ctrl + F: Search Port Name

Upon entering a search string and clicking Search, only port names matching the search string will display in the tree.

## 9. KVM Operation

### Ctrl + E: Edit Favorites

To add a Favorites list:

1. Enter the new Favorites list name in the Name highlight bar.
2. Click Add to add a list in the left menu box.
3. To add a port, move the highlight bar to choose a Favorite list and press [Enter] or [Space], or double-click on a port to select. Click the Update option to save changes or highlight using up/down keys and press [Enter].

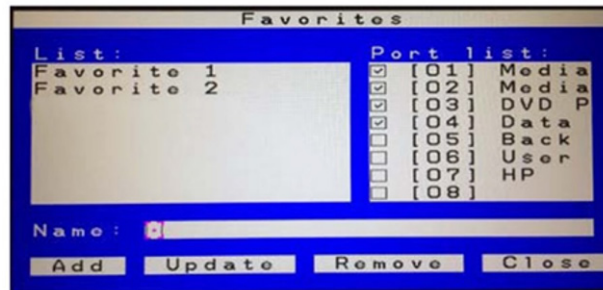

### Ctrl + C: Port properties

The Port Properties page sets the Access Mode, Ports OS, and OS Language for each port.



Access Mode

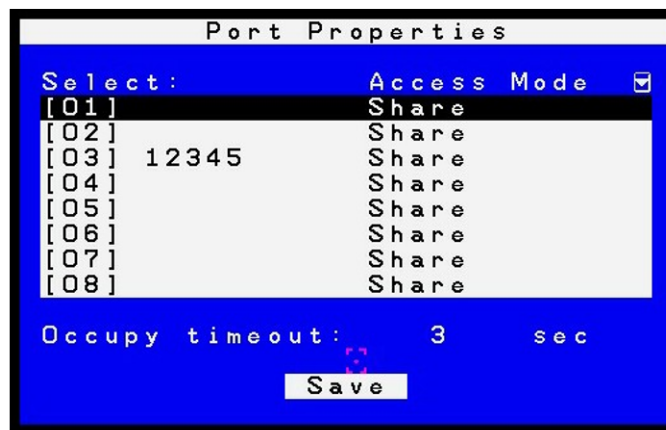

Access Mode determines how the port is to be accessed when multiple users have logged on, as follows:

- Exclusive: The first user to switch to the port has exclusive control over that port. No other users can view the port. The Timeout function does not apply to ports with this setting enabled.
- Occupy: The first user to switch to the port has control over that port. However, additional users may view the port's video display. If the user controlling the port is inactive for longer than the time set in the Timeout box, port control is transferred to the first user to move the mouse or strike the keyboard.
- Share: Users simultaneously share control over the port. Input from the users is placed in a queue and executed chronologically. Under these circumstances, users can take advantage of the Message Board to communicate with one another for control of the keyboard and mouse, as well as keyboard, mouse, and video of a Share port.

## 9. KVM Operation

### Port OS

Specifies the operating system the server on the connected port is using. Choices are *Win*, *Mac*, *Sun*, and *Other*. The default is *Win*.



### OS Language

Specifies the OS language used by the server on the connected port. Use the drop down list to view the available choices. The default is *US English*.

## 10. Logging In to the KVM over IP

Three methods can be used to connect to the KVM switch over IP: Web Browser, AP Windows Client and AP Java Client. The web interface appearance will vary slightly, depending on which method is used.

### 10.1 Web Browser

The B030-008-17-IP can be accessed via an internet browser running on any platform. To access the device:

1. Open the browser and specify the IP address of the switch to access in the browser's URL bar.

**Note:** For security purposes, a login string may have been set by the administrator. If so, include a forward slash and the login string, along with the IP address when logging in. (e.g. 192.168.0.100/abcdefg). If the IP address and/or login string is not known, contact your System Administrator.

2. When a Security Alert dialog box appears, accept the certificate (it can be trusted). If a second certificate appears, accept it as well. Once all certificate(s) are accepted, the login page will appear.

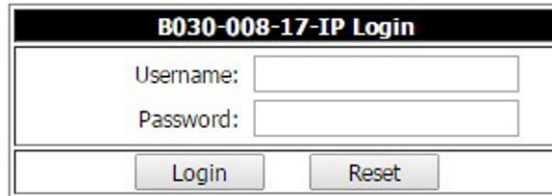

3. Provide your username and password (set by the administrator), then click Login to access the Web Configuration Interface Main Page.

### 10.2 AP Windows Client Login

When connecting the KVM switch via web browser is not desired or feasible, the AP Windows Client found on the included CD-ROM provides non-browser access to the KVM switch via a Windows computer. If access to the AP Windows Client software is restricted, contact your System Administrator.

**Notes:**

- The AP Windows Client can also be downloaded from the Web Configuration Interface.
- The AP Windows Client requires Direct X 8.0 or higher be installed on your computer.

1. Save the AP Windows Client to a desired location on a Windows computer.
2. Double-click on the file and follow the installation instructions.
3. When the installation is complete, a shortcut icon will be added to the desktop, and a program entry will be made in the Windows start menu. Double-click on the icon or select the program entry in the start menu to open the AP Windows Client.
4. The AP Windows Client main screen will appear.

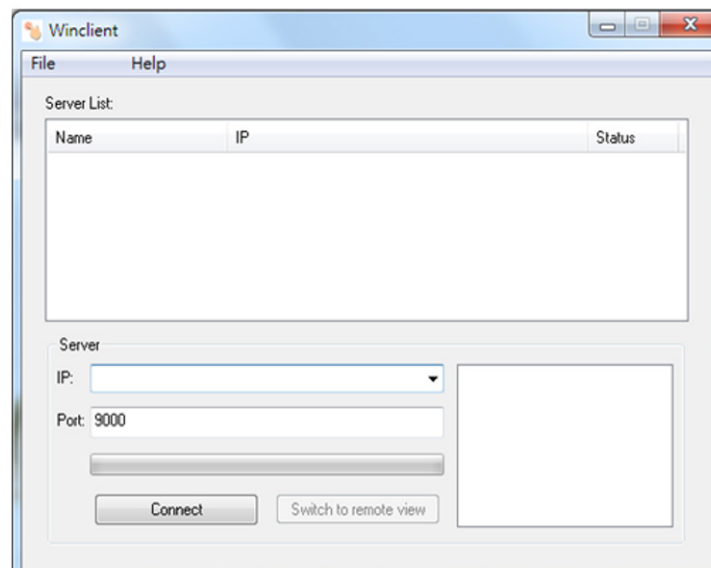

## 10. Logging In to the KVM over IP

- The AP Windows Client will search the network for any KVM switches and display their Model Name(s) and IP Address(es) in the main screen's Server List. If the KVM you wish to connect to is displayed in the list, highlight it and click the Login button. If not, enter the IP address and port number assigned to it and click the Login button.

**Note:** The default port number assigned to the KVM is **9000**.

- A prompt will appear asking to enter your username and password. If accessing the KVM for the first time, enter in the username **administrator** and the password **password**. For security purposes, changing the username and password is strongly recommended.

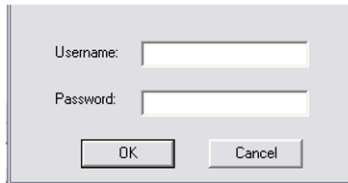

Username:

Password:

OK Cancel

- After entering the username and password, the *Switch to Remote View* button on the main screen will become active. Click on the *Switch to Remote View* button to remotely connect to the KVM switch.

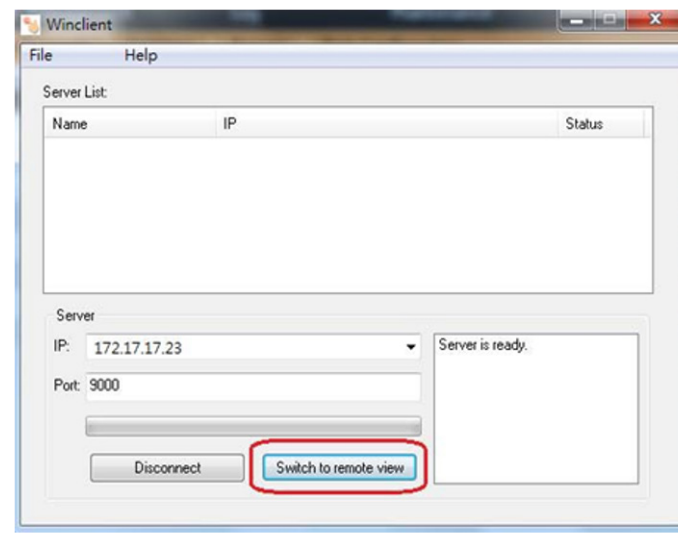

# 10. Logging In to the KVM over IP

## AP Windows Client Connection Screen

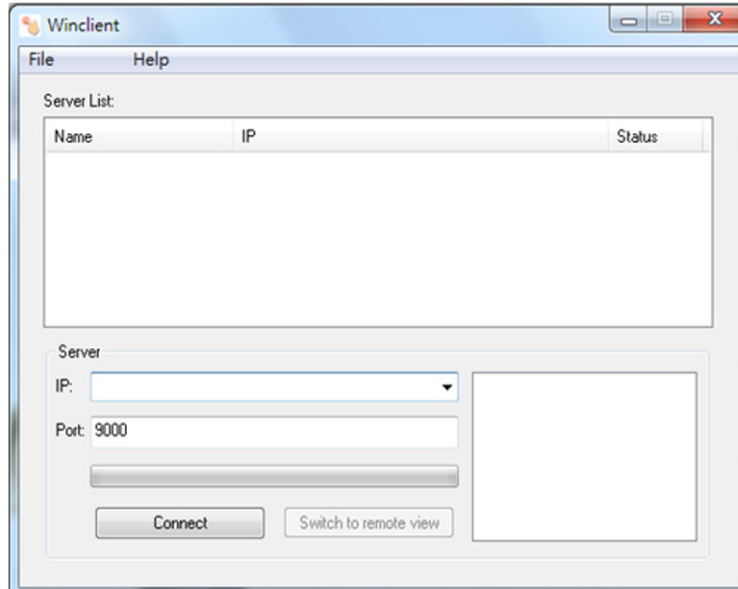

Menu Bar	The Menu Bar contains two menus: File and Help. The File Menu allows the operator to Create, Save, and Open Work files. The Help Menu displays the AP Windows Client version number.
Server List	Each time the WinClient.exe file is run, it searches the User's LAN segment for B030-008-17-IP KVM Switches and lists in the box any that are found. Double-click on any of the devices in this list to connect.  <b>Note:</b> For a switch to appear in the Server List, the Enable Client AP Device List check box in the Operating Mode page of the Web Interface's Device Management section must be checked and the Program service port in the Network page must be set to the same number as in the AP Windows Client Port field.
Server	This area is used when connecting to a B030-008-17-IP KVM Switch at a remote location: <ul style="list-style-type: none"> <li>• Click on the IP drop-down and select an address from the list. If the desired address is not listed, enter the target IP address in the IP field and its port number in the Port field.</li> <li>• Once the IP address and port number have been specified, click Connect to show a login dialog box. Enter the username and password as provided by your system administrator and click OK to establish a connection with the B030-008-17-IP KVM Switch.</li> <li>• When the session has ended, click Disconnect to terminate the connection.</li> </ul>
Message List	Lists status messages regarding the connection to the B030-008-17-IP.
Switch to Remote View	Once a remote connection with a B030-008-17-IP KVM Switch has been established, this button becomes active. Click the button to switch to the KVM Switch's Web Interface Page.

### The File Menu

The File Menu allows the operator to Create, Save, and Open Work Files. A Work File consists of all the information specified in a Client session. This includes the items in the Server List and Server IP List.

Whenever a user runs the Client program, it opens with the values contained in the current Work File (i.e. values that were in effect when the program was last closed).

New	Allows the user to create a named work file so its values will be saved and available for future use.
Open	Allows the user to open a previously saved work file and use the values contained in it.
Save	Allows the user to save the values presently in effect as the current work file.
Exit	Exits the AP Windows Client.

## 10. Logging In to the KVM over IP

### 10.3 AP Java Client Login

In cases when an Administrator does not want the KVM Switch to be available via browser and the remote user is not running Windows, the AP Java Client provides access to the KVM switch.

After downloading the AP Java Client, double-click on the program download location on your hard disk to show the connection screen. The AP Java Client connection screen is the same as the Windows version, except it does not contain a menu bar with File and Help menus.

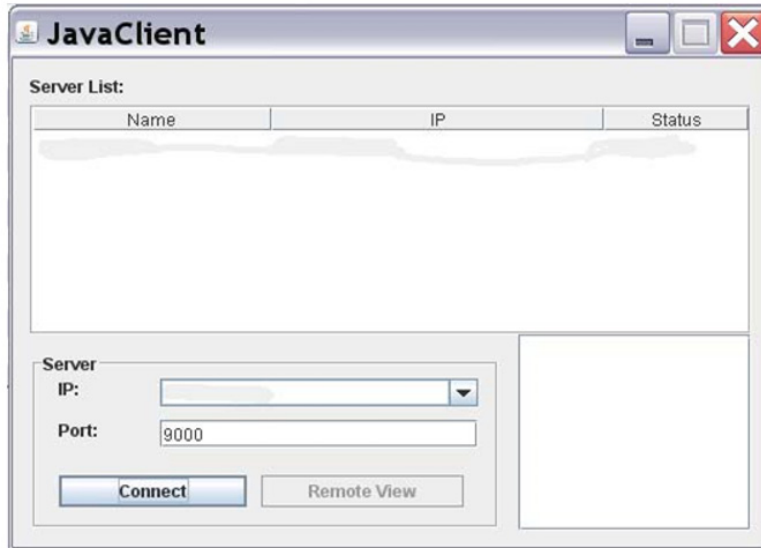

1. If your KVM is displayed in the Server List, connect by highlighting the desired KVM and clicking the Connect button.

**Note:** For a switch to appear in the Server List, the Enable Client AP Device List check box in the Operating Mode page of the Web Interface's Device Management section must be checked and the Program service port in the Network page must be set to the same number as in the AP Windows Client Port field.

2. If your KVM does not display in the Server List, enter its IP address in the IP server field and click the Connect button.
3. A prompt will appear requesting a username and password. Enter your username and password, then click OK.
4. Once connected, the Remote View button will be activated. Click on it to access the KVM remotely. Click the Disconnect button to log out of the KVM switch.

# 11. KVM Web Interface

## 11.1 Web Interface Main Page

When logging into the KVM switch, the following page displays:

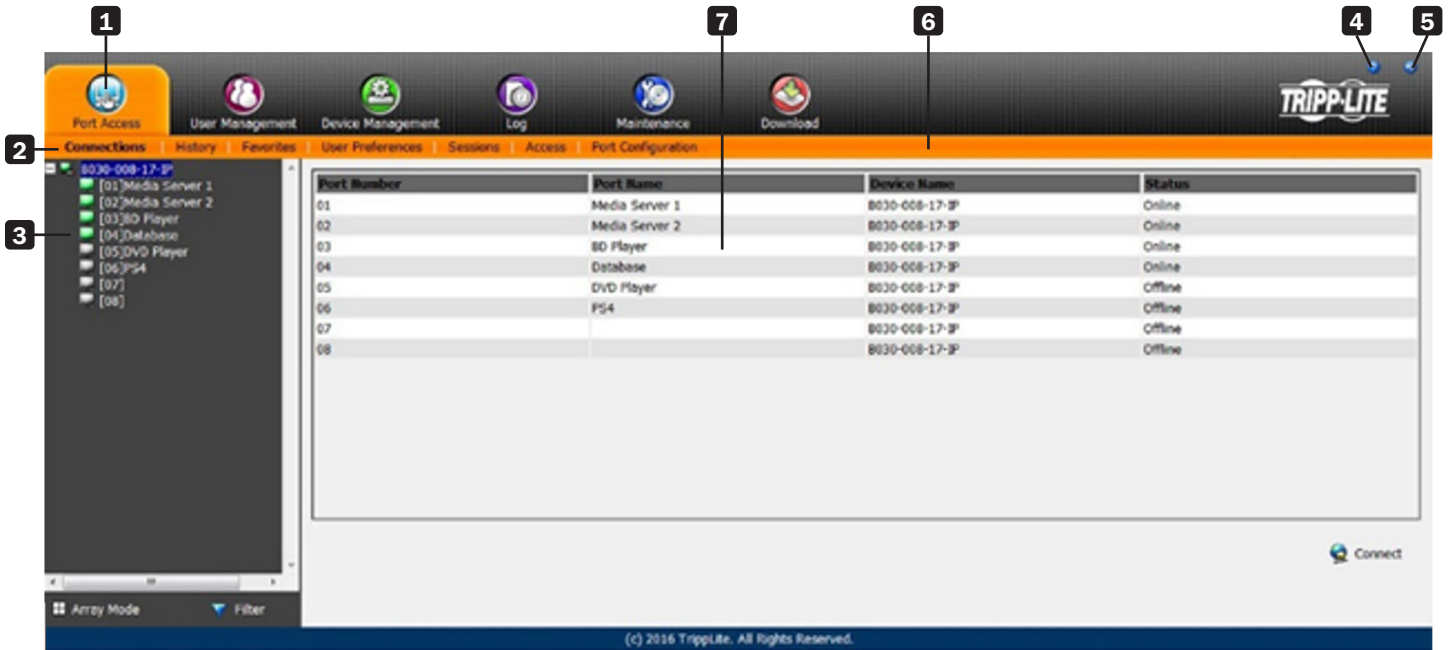







<b>1</b>	Tab Bar	The Tab Bar consists of category icons that direct to various interfaces used to operate the KVM switch. The icons displayed in the Tab Bar depend on the user type and permissions.
<b>2</b>	Menu Bar	The Menu Bar consists of subcategories that display, depending on the user type and permissions.
<b>3</b>	Sidebar	The Sidebar displays a Tree Diagram listing all functions available for the chosen category and subcategory. Clicking on one of the Sidebar functions will show the corresponding interface in the Interactive Display Panel. A Filter button located at the bottom of the Sidebar displays only the parts of the Tree Diagram that have been filtered.
<b>4</b>	About	Shows the KVM switch firmware version.
<b>5</b>	Logout	Logs out the user of the KVM switch.
<b>6</b>	Welcome Message	When enabled, displays a welcome message (disabled by default).
<b>7</b>	Interactive Display Panel	This is the main work area of the Web Interface. Different interfaces are displayed, depending on the category, subcategory and sidebar selections.





# 11. KVM Web Interface

## 11.1.1 Tab Bar

The icons types and quantity appearing on the tab bar are determined by user type and the permissions assigned when the account was created. The functions associated with each of the icons are explained in the table below.

Icon	Description
	<b>Port Access:</b> Is used to access and control the devices on the KVM switch installation. This page is available to all users.
	<b>User Management:</b> Is used to create and manage Users and Groups, and to assign devices to them. This page is available to the Super Administrator and Administrators; ordinary users do not have access.
	<b>Device Management:</b> Is used by the Super Administrator to configure and control the overall operation of the KVM switch. This page is available to Super Administrators or Administrators/Users who have been given access.
	<b>Log:</b> This page displays the log file contents.
	<b>Maintenance:</b> Is used to install new versions of the KVM Switch firmware. This page is available to Super Administrators or Administrators/Users who have been given access.
	<b>Download:</b> Users with appropriate permission can click this icon to download the log server, AP Windows Client and AP Java Client. This page is available to all users, although the downloads a User can access is determined by the Super Administrator or Administrator.

There are two small icons in the upper right-hand corner of the page. Their functions are:

Icon	Function
	Initiates a panel with information about the B030-008-17-IP firmware version.
	Log outs and ends the B030-008-17-IP session.

## 11.2 Port Access

The Port Access section in the OSD is where users can access KVM ports and control settings affecting that access.

### 11.2.1 Connections

The KVM switch and its ports are listed in a tree structure at the left of the panel.

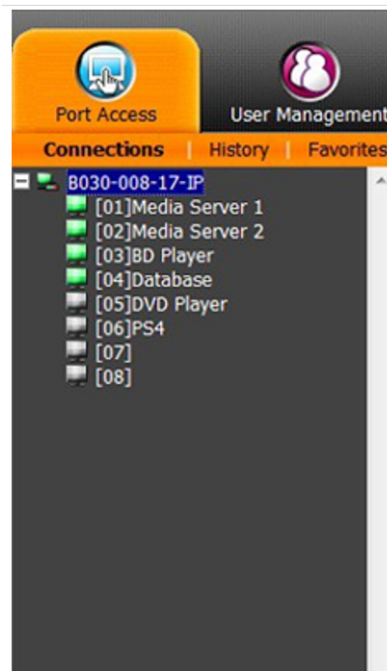

# 11. KVM Web Interface

When accessing a port for the first time via web browser, users will experience a series of prompts:

## Internet Explorer

When logging onto the KVM switch via Internet Explorer, the default viewer is the Windows ActiveX viewer. To use the Java Viewer when accessing the KVM switch via Internet Explorer, the Viewer setting in the User Preferences page must first be updated.

**Note:** Windows 7 users must run Internet Explorer as an administrator for the Active X control to work properly. The user will not be able to access the connected computers if Internet Explorer is not running as an administrator.

1. When using the Windows ActiveX Viewer and clicking on a port for the first time, a screen prompt will appear to install the Windows ActiveX control. Click on the prompt and choose to install the ActiveX control.

**Note:** The screen may display a page stating that the web page's certificate cannot be trusted. If this is the case, click on the option to continue to the web page anyway.

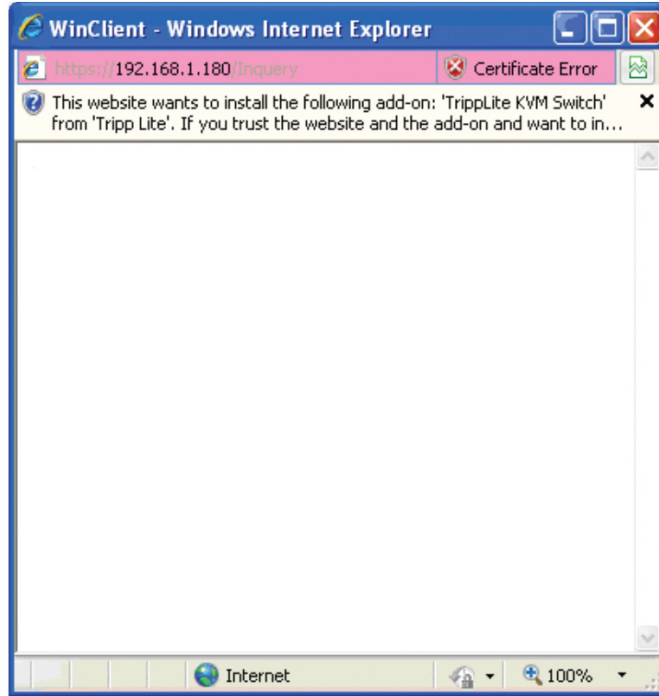

2. Once the ActiveX control is installed, a prompt may appear to resend the information in order to display the web page. Click *Retry*.

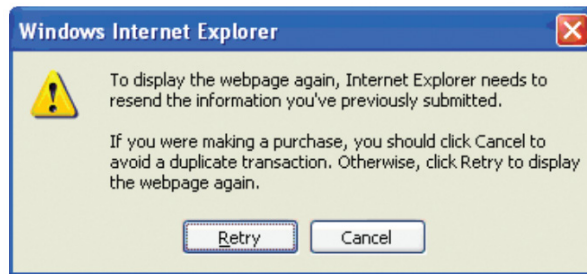

3. A prompt will appear requesting to install the software. Click *Install*.



# 11. KVM Web Interface

## Non-Windows Browser

Users using a non-Windows browser will automatically be connected to remote computers using the Java Viewer.

1. When clicking on a port for the first time, a prompt will appear to run the Java Viewer. Click *OK*. To avoid this prompt every time you access a port, check the *Do this automatically for files like this from now on* box.

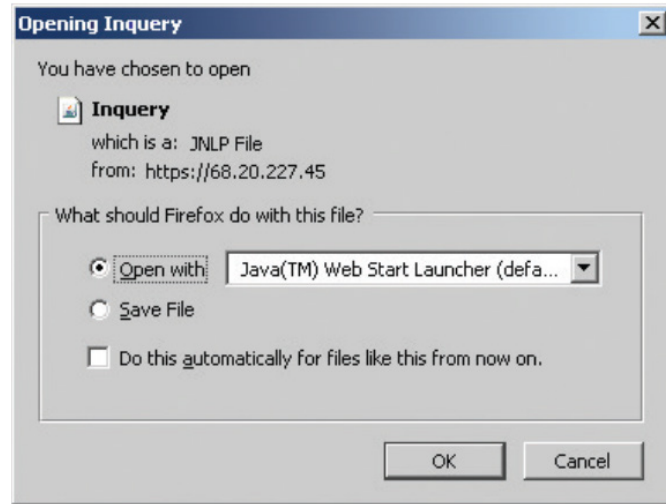

2. A prompt to run the Java Viewer will appear. Check the *Always trust content from this publisher (Tripp Lite)* box, then click *Run*.

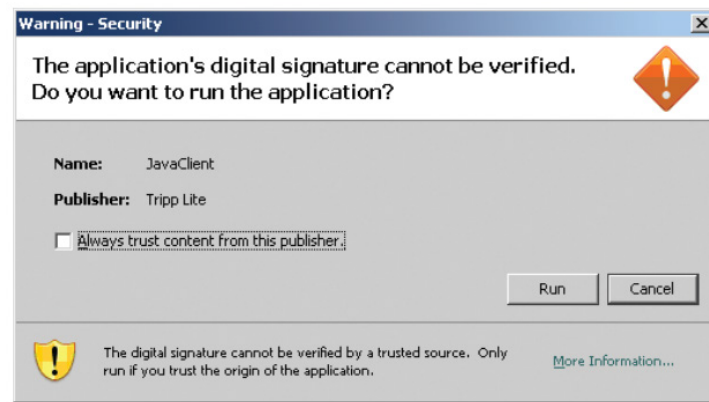

## 11.2.2 Port Selection List

- Users only see the ports they have been given access to.
- Ports are located under their parent switch. Click the Plus (+) in front of a switch to expand the tree and view the ports underneath it.
- When expanded, a Minus (-) appears before the KVM's device name. Click the Minus (-) to collapse the tree and hide the ports.
- A port's ID number is displayed in brackets next to the port icon. For convenience, each port can be given a unique name in addition to this ID.
- Online KVM switches and ports will have green monitor screen icons. Gray monitor screens indicate offline devices and ports.

## 11.2.3 Port Naming

For convenience, each port can be given a unique name. To assign, modify or delete a port name, follow the instructions below.

**Note:** Administrators and Users must be allowed configuration access to a KVM or computer port in order to edit the port name.

1. Click once to highlight the port you want to edit, wait one second and click on it again.  
**Note:** This is not a double-click; it involves two separate clicks. Double-clicking switches the user to the device attached to the port.
2. After a moment, the display will change to provide a text input box. Enter a name for the port (or change/delete a previous one). The maximum number of characters allowed for a port name is 20. Any combination of letters, numbers, and symbols on the keys of keyboards with PC US English layout can be used.
3. Once finished editing the port name, press [Enter] or click anywhere outside of the input box to complete the operation.

# 11. KVM Web Interface

## 11.3 Web Interface Icons and Controls



Panel Array Mode

Panel Array Mode permits port activity to be monitored automatically. When activated, the screen displays a grid of panels, with each panel representing a port on the installation. Only ports that are online and user accessible are displayed. Offline or non-accessible ports are left blank.



Filter

Filter controls which ports are displayed in the Port Selection List, as well as which ports are scanned when Auto Scan Mode is initiated. When Filter is clicked, the bottom panel changes will appear as shown in the image below:

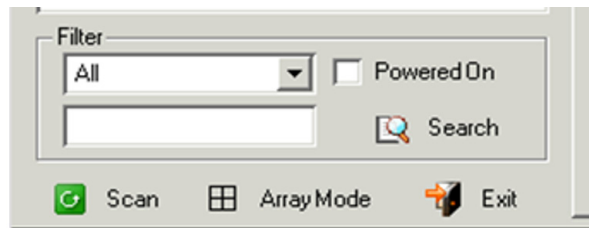

All – with no other filter options selected, lists all of the ports on the installation.

- Checking the *Powered On* box only lists ports that have their attached devices powered on.
- The text input field and Search button allow the user to input a search string so that only matching ports appear in the list.
- Clicking Exit closes the filter dialog.

## 11.4 Interactive Display Panel

### 11.4.1 Device Level

When a KVM switch is selected in the Sidebar tree, the ports accessible to the logged-on user will appear.

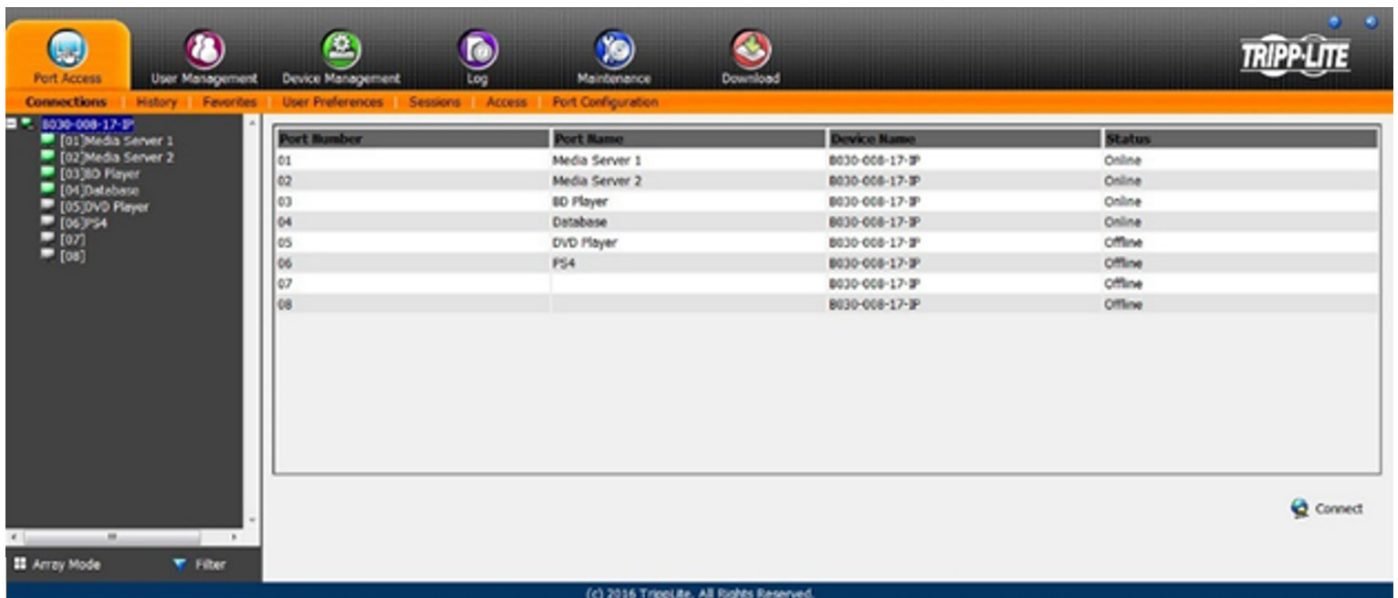

Attribute	Description
Port Number	The KVM switch port the computer or KVM is connected to.
Port Name	If a port is assigned a name, it is displayed here.
Device Name	The name of the KVM switch the port is on.
Status	Current status of the computer or KVM connected to the port; Online or Offline.
Connect	A Connect icon will be located underneath the port list. Highlight a port and click Connect to open up a remote session with the selected port displayed.

# 11. KVM Web Interface

## 11.4.2 Port Level

When a port is selected in the Sidebar tree, the port connection and configuration options will appear.

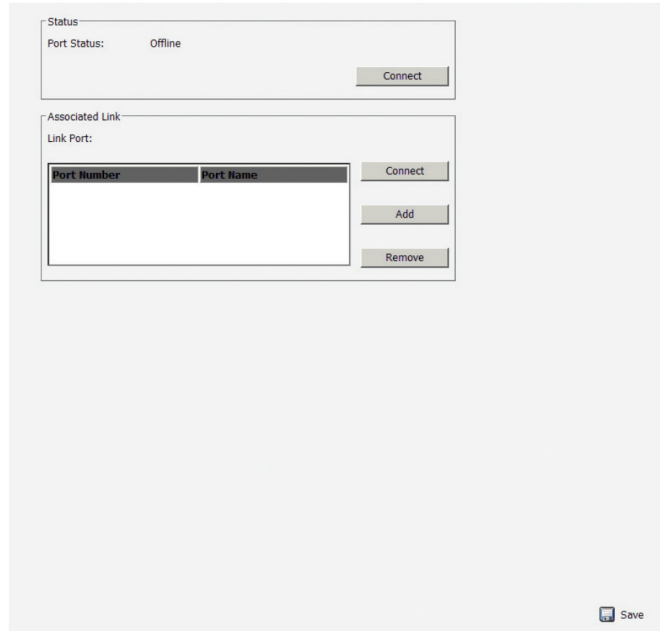

Section	Description
Status	Displays the Port Status; whether it is online or offline, and whether virtual media can be mounted to it. Click the <i>Connect</i> button to open a remote session with the selected port displayed.
Associated Link	Each port can have additional ports associated with it, so that the user can access multiple ports via one connection page. Associated Links can be added/removed from the Port Configuration subsection. When ports are available in the Associated Link section, simply highlight one and click the <i>Connect</i> button to open a remote session with that port displayed.

## 11.5 History

The History page provides a record of each time a port was accessed as well as quick access to the most recently used ports. Users can access a port in the main panel by double-clicking it.

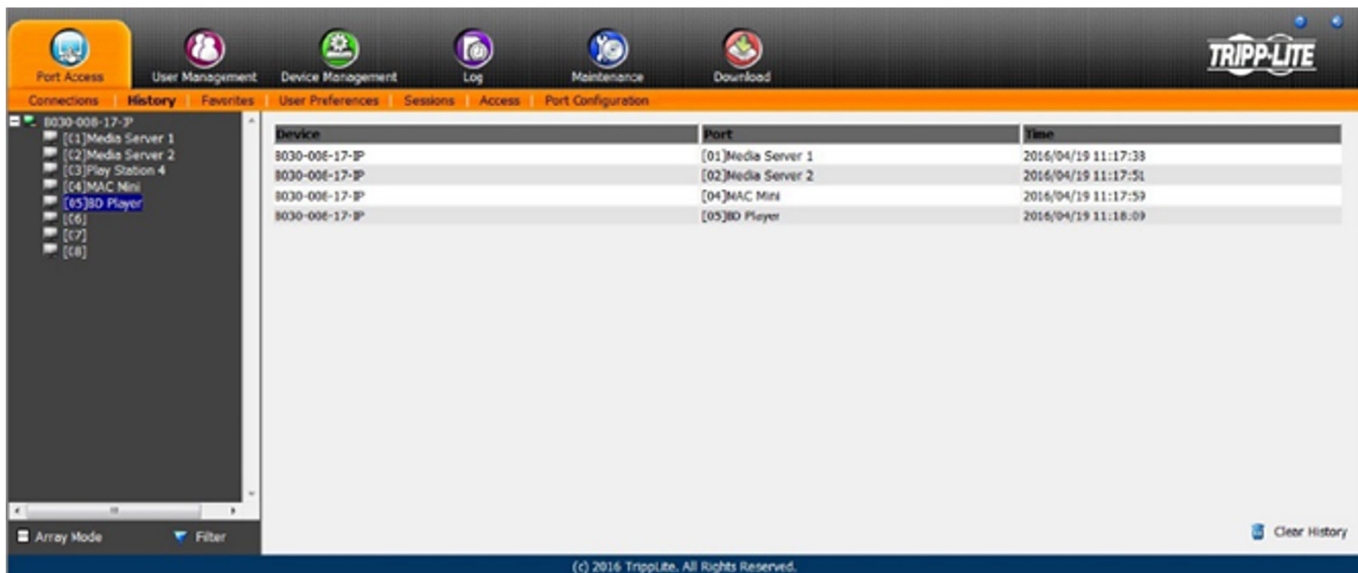

- If there are more entries than there is room on the screen, a scroll bar appears to scroll up and down to see the entire record.
- To clear the record and start over, click the *Clear History* button in the bottom-right corner of the page.

**Note:** The sort order of the information displayed can be changed by clicking the column headings.

# 11. KVM Web Interface

## 11.6 Favorites

Favorites is similar to a bookmarks feature, where frequently visited ports can be listed on this page. Open this page and select the port instead of searching for it in the tree view.

**Note:** Each Favorites bookmark created is a unique folder in which multiple ports can be saved.

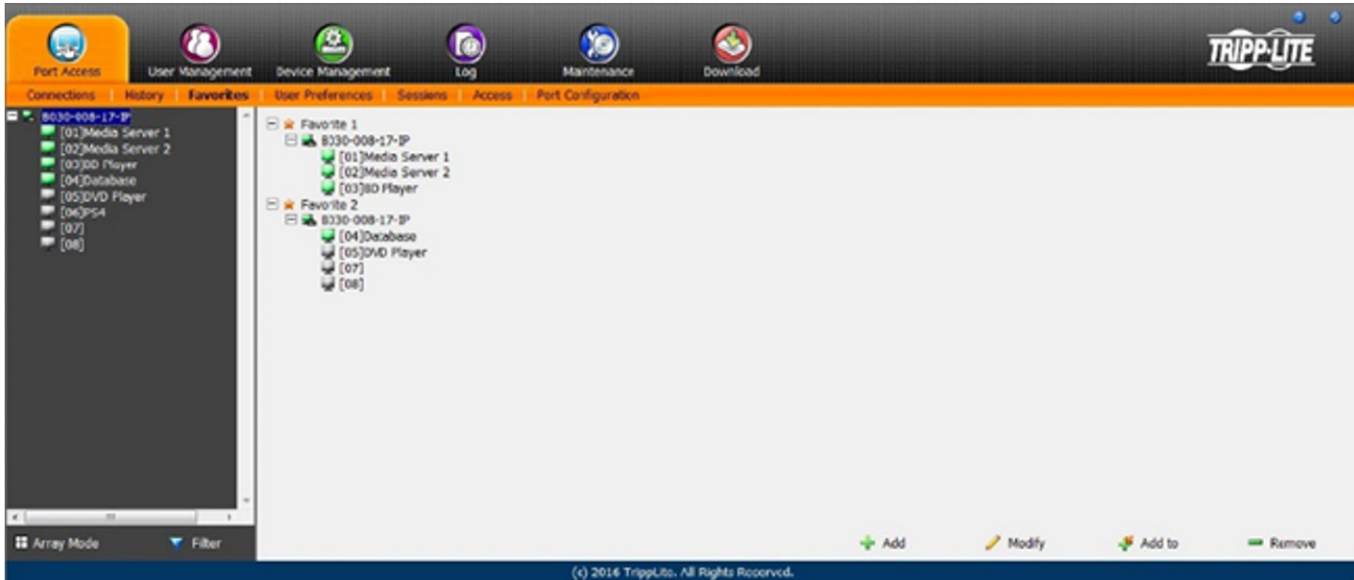

### Adding a Favorite

To add a port to Favorites:

1. Right click in the main panel. Click on the *Add Favorite* option that appears or click *Add* in the bottom-left of the main panel. An entry appears named "Untitled Favorite".

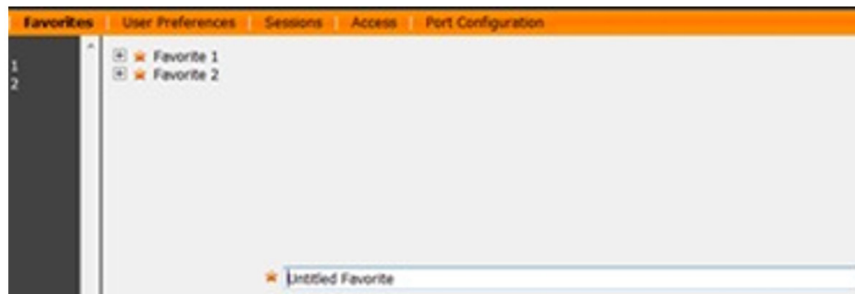

2. Click inside the text entry box to erase "Untitled Favorite" and enter the desired name.
3. To add a port, drag it from the Port Select list and drop into the Favorites bookmark just created. A port can also be added by right-clicking on it and selecting *Copy*. After copying, right-click on the Favorites bookmark and select *Paste*. One final way to do this is to select the Favorites bookmark in the main panel and the desired port in the tree list and then click *Add to* at the bottom of the main panel. The KVM switch the port is connected to goes into the Favorites bookmark along with the port. The port is located under the switch, as it would be in the tree view on the left-hand panel.

# 11. KVM Web Interface

4. Repeat step 3 for any additional ports to add to the Favorites bookmark.



## Modifying a Favorite

To modify a Favorites bookmark, right-click on it and select one of the options from the pop-up menu that appears. To edit a Favorite's name, click on it once, wait a second, then click again. You can edit the name after the display changes to provide a text input box. You can also select the Favorite in the main panel, then click Modify at the bottom of the main panel.

# 11. KVM Web Interface

## 11.7 User Preferences

The User Preferences page allows users to set up their own individual working environments. The KVM Switch stores a separate record for each user profile, and sets up the working environment according to the Username that was used to access the KVM switch.

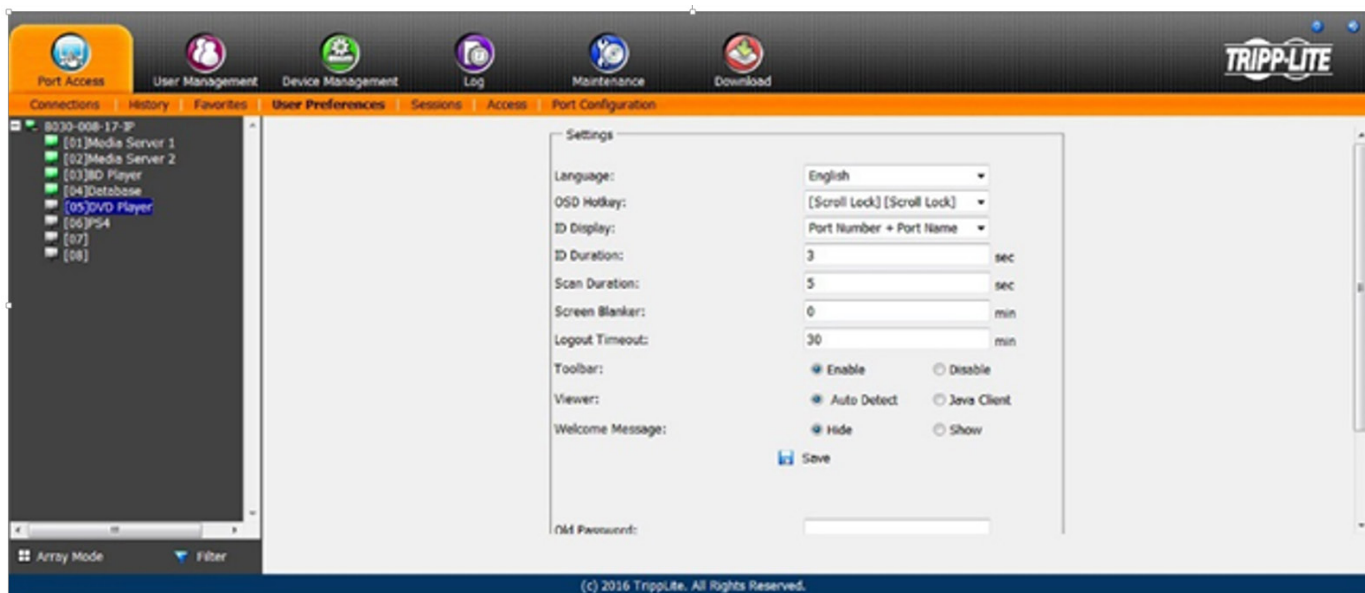

Setting	Description
Language	Selects the interface language. Options include English (default), Spanish, French, German, Russian, Italian, Japanese, Korean, traditional Chinese and simplified Chinese.
OSD Hotkey	Selects which hotkey controls the OSD function. You can choose from the following options; [Scroll Lock] [Scroll Lock], [Ctrl] [Ctrl], [Alt] [Alt], [Shift] [Shift] and [Print Screen] [Print Screen]. The default is [Scroll Lock] [Scroll Lock].
ID Display	Selects how the Port ID is displayed: the Port Number alone (PORT NUMBER); the Port Name alone (PORT NAME); or the Port Number plus the Port Name (PORT NUMBER + PORT NAME). The default is PORT NUMBER + PORT NAME.
ID Duration	Determines how long a Port ID displays on the monitor after a port change has taken place. Choose a duration from 1—255 seconds. The default is 3 seconds. A setting of 0 (zero) means the Port ID is always on.
Scan Duration	Determines how long the focus dwells on each port as it cycles through the selected ports in Auto Scan Mode. Choose a value from 1—255 seconds. The default is 5 seconds; a setting of 0 disables the Scan function.
Screen Blanker	If there is no input from the console for the amount of time set with this function, the screen is blanked. Choose a value from 1—30 minutes. A setting of 0 disables this function. The default is 0 (disabled). When the screen is blank, simply moving the mouse over the screen will make it appear once again. <b>Note:</b> This setting affects the local console monitor only.
Logout Timeout	If there is no user input for the amount of time set with this function, the user is automatically logged out. A login is required before the KVM Switch can be accessed again. The default is 30 minutes.
Toolbar	The Toolbar option enables/disables the OSD Toolbar. As all of the features of the OSD Toolbar are available in the Control Panel, consider disabling it; the default setting is enabled.
Viewer	The Viewer option allows you to choose what viewer is used to access a port. <ul style="list-style-type: none"> <li>Auto Detect – The KVM switch will automatically choose which viewer to use based on the web browser. The Windows Viewer will be used for Internet Explorer and the Java Viewer will be used for all other browsers.</li> <li>Java Client – The KVM switch will always use the Java Viewer, regardless of what browser is being used.</li> </ul>
Welcome Message	The Welcome Message option allows you to show or hide the welcome message that appears in the upper-right corner of the screen. It is disabled by default.
Save	To apply any changes, you must click Save before exiting.
Changing a Password	To change a password, the user must enter the old password and the new password. The new password will need to be entered twice for security purposes. Once entered, click Save to apply the change.



# 11. KVM Web Interface

## 11.8 Sessions

The Sessions subsection allows Super Administrators and Administrators to view users logged in to the KVM switch, and provides information about each session. Super Administrators can view all user accounts logged in to the KVM, whereas Administrators are only able to view Administrator and User accounts.

It also provides the option of ending a session by selecting the account from the Sessions list and clicking the End Session icon. To refresh the Sessions list to display the most current information, click the Refresh icon.

**Note:** The Sessions tab is only available for Super Administrators and Administrators. Users will not be able to access it.

## 11.9 Access

The Access subsection allows Super Administrators and Administrators to set user access and configuration rights for switches and ports. As with the Sessions subsection, Super Administrators can view all user accounts, whereas Administrators can only view Administrator and User accounts.

**Note:** The Access subsection is not available to User accounts and will appear when logged in to the OSD.

If a switch is chosen in the Sidebar, the Main panel will appear as below:

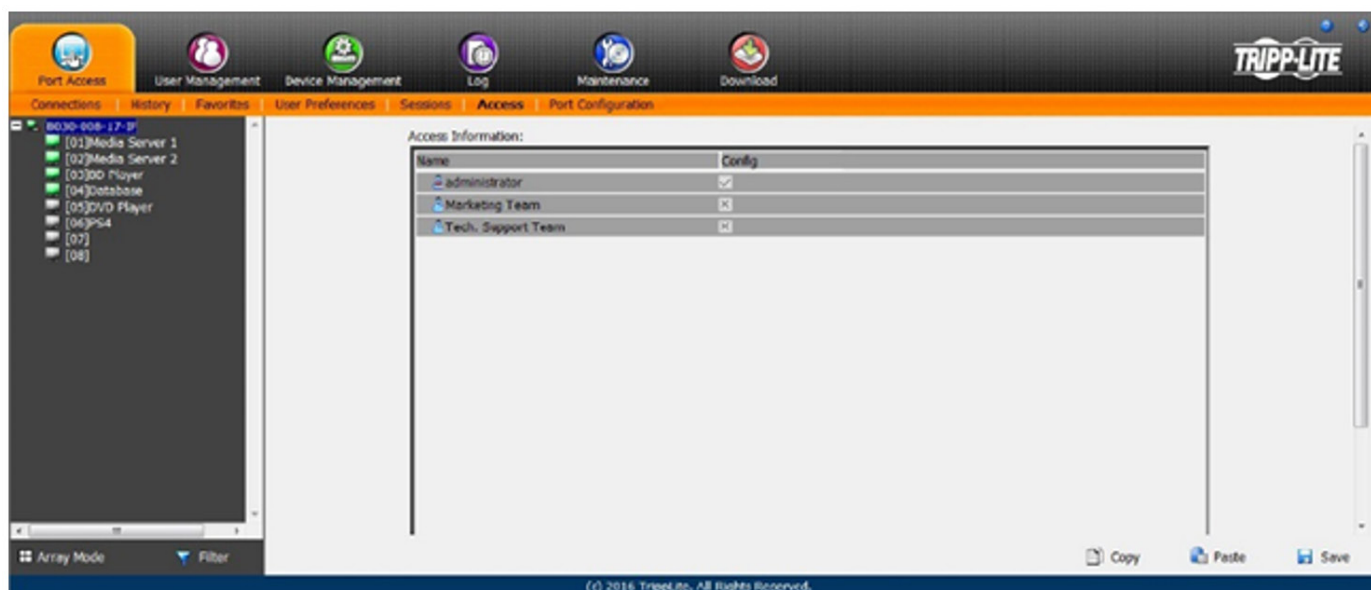

The main panel consists of two columns: *Name* and *Config*:

- *Name* lists all users that have been created.
- *Config* lists users who have Configuration privileges. A check mark ( ✓ ) indicates a user has permission to make changes to the switch configuration settings; an X indicates a user is denied permission to make configuration changes. Click the icon to toggle permission for Administrators and Users (Super Administrators always have configuration privileges).
- The *Copy* and *Paste* buttons at the bottom of the main panel provide a shortcut method of assigning the permissions settings of one port to any of the other ports. To do so:
  1. Select the port whose permissions you want the other port(s) to follow.
  2. Click *Copy*.
  3. Select the port you wish to receive the permissions.
  4. Click *Paste*.
  5. Once the configuration changes are finished, click *Save*.

# 11. KVM Web Interface

If a port is chosen in the Sidebar, the Main panel consists of three columns: *Name*, *Access* and *Config*:

- *Name* lists all users that have been created.
- The *Access* column is where device access rights are set. To cycle through the choices, click the icon in the row that corresponds to the user to be configured. The icons are as follows:



(Full Access) – The user can view the remote screen and perform operations on the remote server from his/her keyboard and monitor.



(View Only) – The user can only view the remote screen and cannot perform any operations.



(No Access) – No access rights; the Port will not appear on the User's list on the Main Screen.

- *Config* sets or denies permission for the user to make changes to a port's configuration settings. A check mark ( ✓ ) indicates a user has permission; an X indicates a user does not have permission.

## 11.10 Port Configuration

The Port Configuration subsection allows Super Administrators and Administrators to edit port properties settings and add/remove associated links. When the master KVM is highlighted and the Port Configuration subsection is selected, the following screen appears.

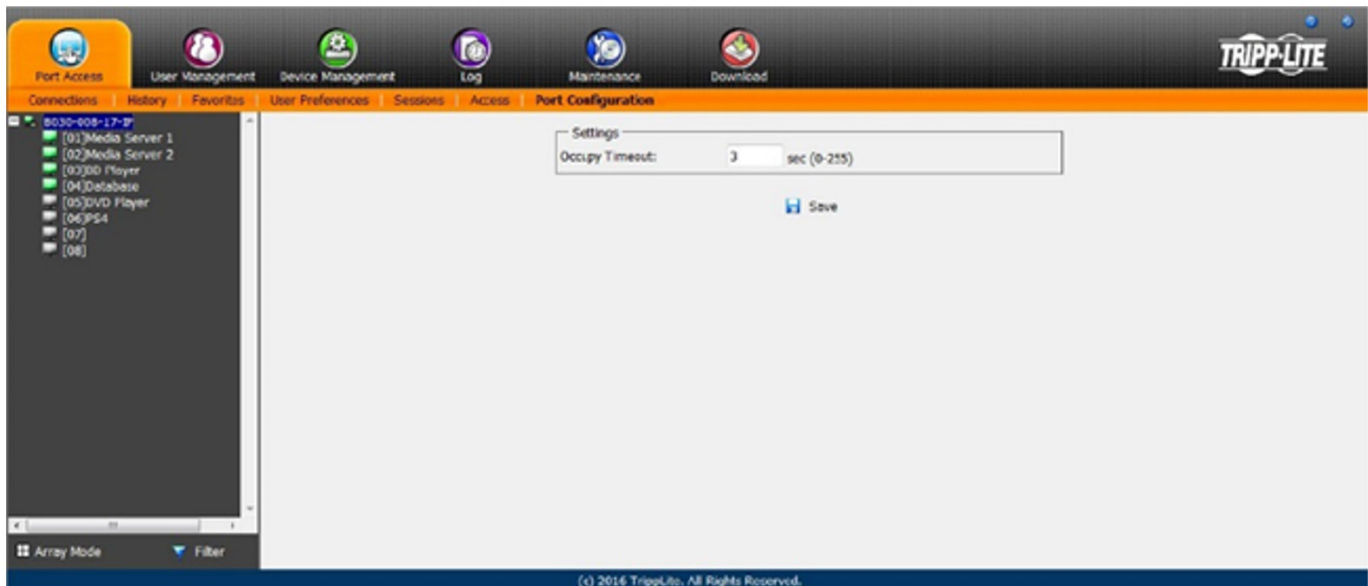

The only setting that appears on this page is the Occupy Timeout setting. This setting controls the amount of inactivity time before a port set to Occupy (see Access Mode in the table on the following page for details) is opened for access by another user. Enter a value from 0 to 255 seconds. The default is 3 seconds.

# 11. KVM Web Interface

When a standard port is highlighted and the Port Configuration subsection is selected, a screen opens up containing two sections; Port Property and Associated Link. The Port Property section is opened first by default.

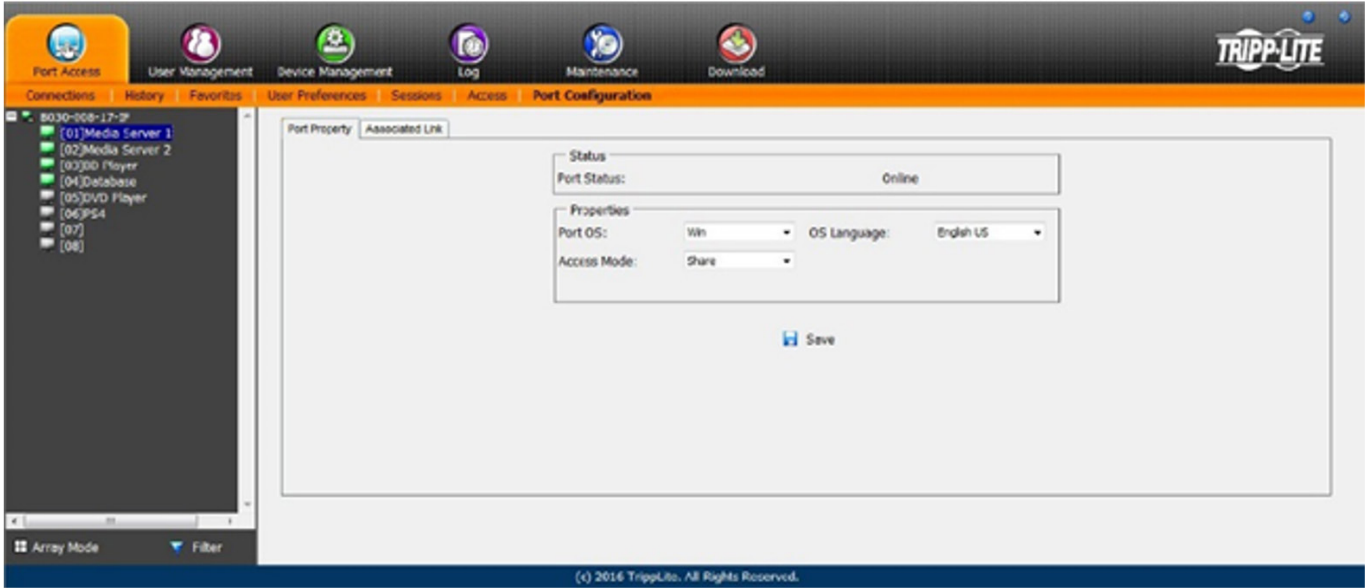

Field	Explanation
Port OS	Specifies the operating system the server on the connected port is using. Choices are Win, Mac, Sun, and Other. The default is Win.
OS Language	Specifies the OS language being used by the server on the connected port. Drop down the list to see the available choices. The default is English US.
Access Mode	<p>Defines how the port is accessed when multiple users have logged on.</p> <ul style="list-style-type: none"> <li>Exclusive: The first user to switch to the port has exclusive control over the port. No other users can view the port. The Timeout function does not apply to ports with this setting.</li> <li>Occupy: The first user to switch to the port has control over the port. However, additional users may view the port's video display. If the user controlling the port is inactive for longer than the time set in the Timeout box, port control is transferred to the first user to move the mouse or strike the keyboard.</li> <li>Share: Users simultaneously share control over the port. Input from the users is placed in a queue and executed chronologically. Under these circumstances, users can take advantage of the Message Board to communicate with one another regarding control of the keyboard and mouse, or keyboard, mouse and video of a Share port.</li> </ul>

Once configuration changes have been made, click Save.

# 11. KVM Web Interface

## 11.11 Associated Link

This page associates links to other ports in the installation with the highlighted port. When an associated link is made, it is displayed in the Associated Link table of the port's Connections screen.

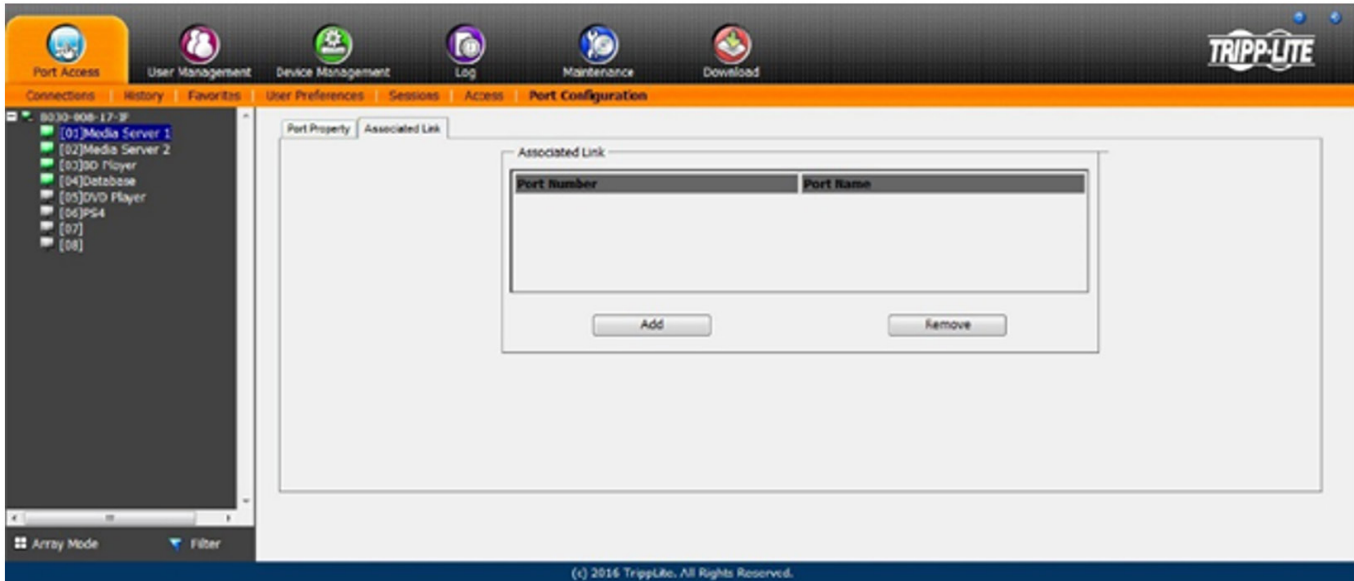

To add an associated link, click the *Add* button, enter the desired port number in the box that appears, and click the *OK* button. It will then appear in the list of associated links. To remove a link, simply highlight it and click the *Remove* button.

## 11.12 User Management

The User Management section allows Super Administrators, and Administrators and Users given User Management permission, to add/edit accounts on the KVM switch. If an account has not been given User Management permission, the User Management icon will not appear in the OSD when logging in.

**Note:** Administrators with User Management permission can only add/edit Administrator and User accounts. Users with User Management permission can only add/edit User accounts. Super Administrators can add/edit all account types.

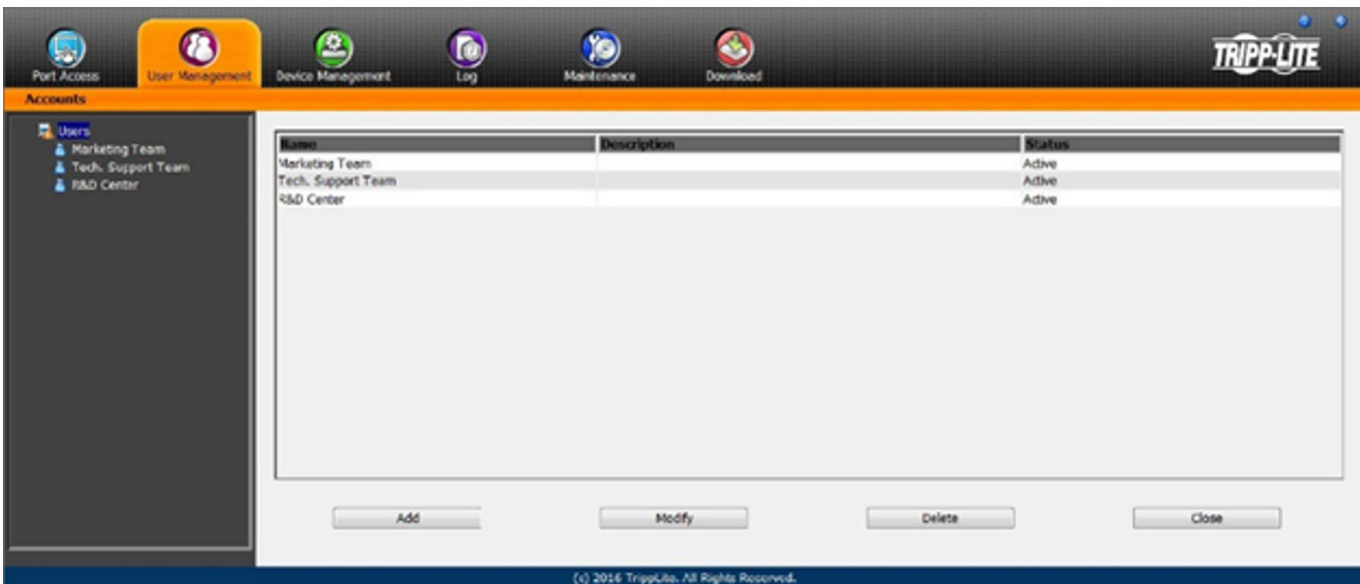

# 11. KVM Web Interface

## Adding User Accounts

To add a new user account:

1. Highlight Users from the list on the left side of the page, then click the *Add* button located at the bottom of the screen. The user information page will open.

2. Enter the appropriate information for the account being created. The field descriptions can be found in the table below. Click the Save button when all relevant fields have been filled in.

Field	Description
Username	Enter an account username. The username can contain up to 16 characters and must meet the Account Policy requirements set in the Security subsection.
Password	Enter an account password. The password can contain up to 16 characters and must meet the Account Policy requirements set in the Security subsection.
Confirm Password	For security purposes, the password must be re-entered. If the password does not match the password entered in the previous field, you will not be allowed to save the account information.
Description	Enter any additional information to describe the account. This is an optional field.
Role	<p>Select the account type; Super Administrator, Administrator or User. There is no limitation on the number of each account type that can be created, only a limit on the number of total accounts. Up to 64 accounts on the KVM switch can be created.</p> <ul style="list-style-type: none"> <li>• Super Administrator – This account type has full access to all aspects of the KVM switch. They can fully access all computers/devices connected to the KVM, change any and all settings, and add/edit any account type.</li> <li>• Administrator – This account type defaults at full access to the KVM switch (the same as a Super Administrator); however, the ports the account has Configuration access to are determined by a Super Administrator or Administrator who creates/edits the account. In addition, Administrators with User Management permission are limited to adding/editing Administrator and User accounts.</li> <li>• User – This account type defaults with no access to the KVM switch, and is only given the initial permissions of Windows Clients and Java Clients. Super Administrators and Administrators can customize a User profile as they see fit. If a User is given User Management permission, they are only allowed to add/edit other User accounts.</li> </ul>

## 11. KVM Web Interface

Field	Description
<p>Permissions</p> <p><b>Note:</b> For ordinary users, in addition to enabling Device Management, Port Configuration, and Maintenance permissions, the user must also be given those rights for each device and port that he/she will be allowed to manage. See <b>11.12.1 Device Assignment</b> for details.</p>	<p>The permission settings determine what functionality the account is able to use. Check the box next to the permission to enable it to that account. Leave it unchecked to deny the account access to that functionality.</p> <ul style="list-style-type: none"> <li>• Device Management – Gives an account access to the KVM settings found in the Device Management section, such as network and advanced network management (ANMS). If this box is not checked, the Device Management icon will not appear when the account logs into the OSD.</li> <li>• Port Configuration – Allows an account to edit the Port Configuration settings for individual KVM ports.</li> <li>• User Management – Allows an account to add/edit other accounts. Administrators can add/edit Administrator and User accounts. Users can add/edit other User accounts. Super Administrators can add/edit all account types. If this box is not checked, the User Management icon will not appear when the account logs into the OSD.</li> <li>• Maintenance – Gives the account access to the settings and functionality found in the Maintenance section, which includes upgrading the KVM firmware. If this box is not checked, the Maintenance icon will not appear when the account logs into the OSD.</li> <li>• System Log – Gives the account access to the Log section of the OSD, where they can view events that have taken place on the installation. If this box is not checked, the Log icon will not appear when the account logs into the OSD.</li> <li>• View Only – Limits the account to viewing the video of connected computers only. They will not be able to perform keyboard and mouse functions.</li> <li>• Windows Client – Gives the account access to the browser and non-browser versions of the Windows client.</li> <li>• Java Client – Gives the account access to the browser and non-browser versions of the Java client.</li> <li>• Force to Grayscale – Forces the account to view remote video without color.</li> </ul>
Status	<p>This section determines how long an account or password is valid until it expires or needs to be changed.</p> <ul style="list-style-type: none"> <li>• Disable Account – Disables an account and prevents it from accessing the KVM switch. This provides an alternative to deleting the account, in which the account can be disabled and then reinstated for future use without having to re-enter the account settings.</li> <li>• Account Never Expires – If this option is checked, the account will stay active forever or until deactivated manually.</li> <li>• Account Expires On – To set a date for the account to be disabled, check this box and enter in a date in the corresponding field.</li> <li>• User Must Change Password at Next Logon – To force the account to change its password the next time they logon, check this box. The next time the account logs on, the user will be prompted to enter a new password.</li> <li>• User Cannot Change Password – Check this box to prohibit the user from changing their password.</li> <li>• Password Never Expires – If this option is checked, the account's password will stay active forever or until manually forced to be changed.</li> <li>• Password Expires After – To force an account to change its password after a certain number of days, check this box and enter in the number of days until the password expires.</li> </ul>

3. Upon clicking Save, a prompt will appear stating that the operation succeeded. Click *OK* to exit.

### Modifying User Accounts

1. Select the desired user's name from the User List or the Main Panel and click *Modify*.
2. Make any necessary changes to the user account and click *Save*.

### Deleting User Accounts

1. Select the user's name from the Main Panel and click *Delete*.
2. A confirmation dialog box will appear asking if you are sure you want to delete the selected user account. Click *OK*.

# 11. KVM Web Interface

## 11.12.1 Device Assignment

When a user logs on to the KVM switch, the ports they are allowed to access are displayed in the port list. Ports they are not allowed to access are not displayed. Port access rights, as well as access to configuration settings, are assigned on a port-by-port basis in the user Device tab. To access the Device tab, first access the user information page, then click on the *Device* tab at the top of the page.

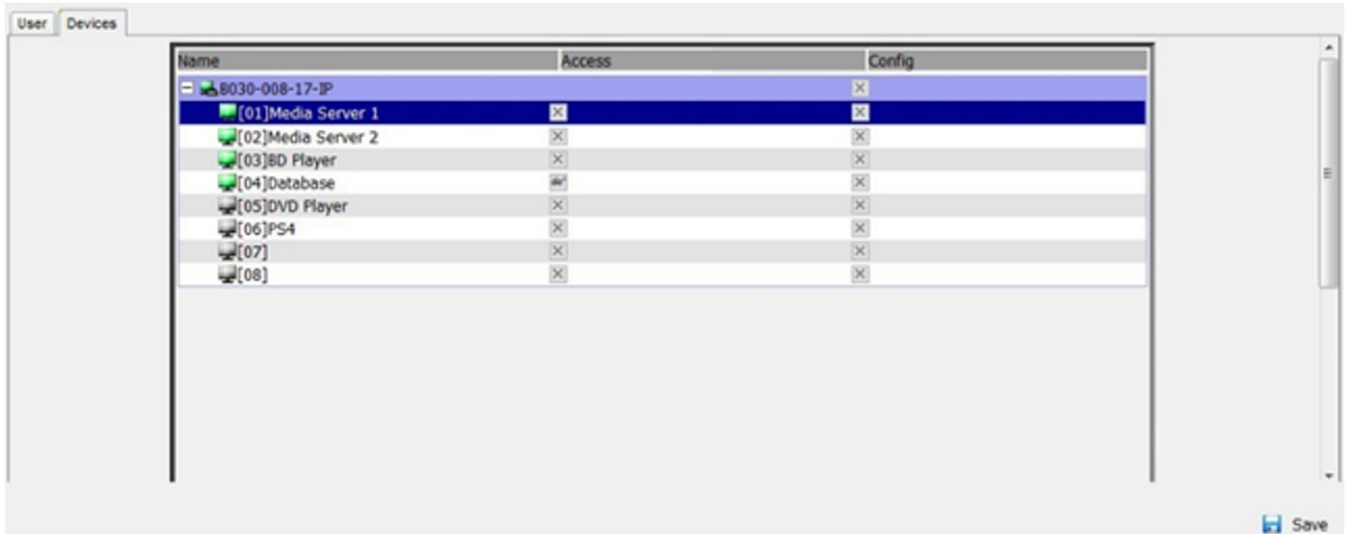

The Device tab page includes a list of the master KVM switch and its ports on the left side, and two permission columns on the right side.

- Access – Determines if the account can access the port, and if so, whether the account is allowed Full Access, View Only access or No Access.



(Full Access) – The user can view the remote screen and perform operations on the remote server from his/her keyboard and monitor.



(View Only) – The user can only view the remote screen and cannot perform any operations.



(No Access) – No access rights; the Port will not appear on the User's list on the Main Screen.

- Config – If the box is checked (  ) next to a port, the account is given access to edit the Port Configuration settings.

**Note:** For Configuration access to take effect, the account must also have been given Port Configuration permission. (Refer to the Adding User Accounts section in **11.12 User Management** for details.)

Once finished assigning permissions, click the Save button. In the confirmation popup, click OK.

**Note:** You can simultaneously assign to multiple ports using the [Shift] or [Ctrl] keys. To highlight a group of consecutive ports, start by highlighting the first port, hold down the [Shift] key, then highlight the last port that you wish to highlight. All ports from the first one highlighted to the last will be highlighted. Then click on any of the permission boxes to change that permission for the highlighted ports. To highlight multiple non-consecutive ports, start by highlighting the first port, hold down the [Ctrl] key then highlight each additional port one-by-one while continuing to hold down the [Ctrl] key. When all of the desired ports are highlighted, click on any box to change that permission for all of the highlighted ports.

## 11.12.2 Device Management

The Device Management section allows Super Administrators and Administrators/Users who have been given permission, to configure and control the KVM switch.

# 11. KVM Web Interface

## 11.12.3 Device Information

When the Device Management icon is selected, it opens with the Device Information page displayed.

**Note:** If you do not have permission to configure the KVM switch, the Device Management icon will not appear when you log onto the KVM.



The General Device Information page displays the name of the selected device, its firmware version, the FPGA (Field-Programmable-Gate-Array) and information about its network configuration.



# 11. KVM Web Interface

## 11.13 Operating Mode

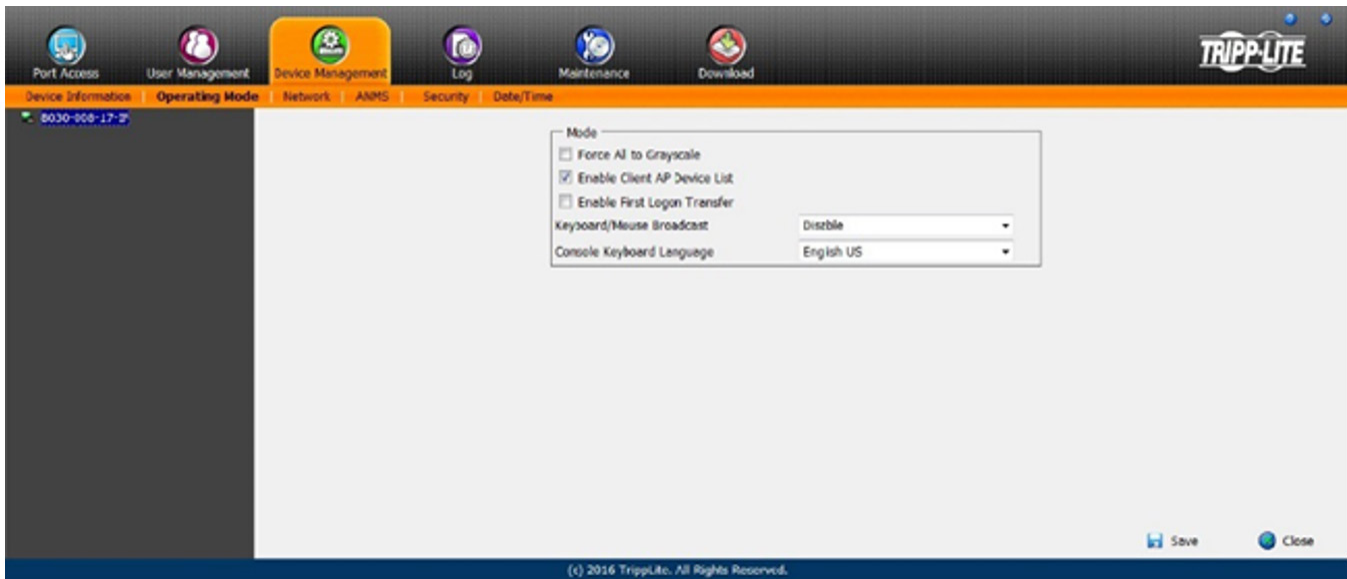

The Operating Mode subsection allows the working parameters of the KVM to be set.

- If *Force all to grayscale* is enabled, the remote displays of all devices connected to the 8030-008-17-IP are changed to grayscale. This can speed up I/O transfer in low bandwidth situations.
- If *Enable Client AP Device List* is enabled, the switch will appear in the Server List when using the WinClient or Java Client AP. If this option is not enabled, the switch will remain connected, but its name will not appear in the Server List.
- If *Enable First Logon Transfer* is enabled, only the first user to access a port can switch ports. Other users cannot switch ports unless the first user to logon logs out.
- For the *Keyboard/Mouse Broadcast* setting, select the desired choice from the dropdown menu.
  - If *Keyboard Broadcast* is enabled, keystrokes will be duplicated on all the attached servers that appear in the Sidebar.
  - If *Mouse Broadcast* is enabled, mouse movements and clicks will be duplicated on all the attached servers that appear in the Sidebar. For Mouse Broadcast to work correctly, all connected computers must be running the same OS and all screens must have an identical layout.
  - Choose *Disable* to Disable Keyboard/Mouse Broadcast.
- The *Console Keyboard Language* setting specifies which keyboard mapping is being used by the Local Console keyboard. Select the desired choice from the dropdown menu.

## 12. Network Settings

IP Installer

Enabled     View Only     Disabled

---

Service Ports

Program:

HTTP:

HTTPS:

---

IPv4 Settings

IP Address:

Obtain IP address automatically [DHCP]

Set IP address manually [Fixed IP]

IP Address:

Subnet Mask:

Default Gateway:

DNS Server:

Obtain DNS server address automatically

Set DNS server address manually

Preferred DNS server:

Alternate DNS server:

---

IPv6 Settings

IP Address:

Obtain IPv6 address automatically [DHCP]

Set IPv6 address manually [Fixed IP]

IPv6 Address:

Subnet Prefix Length:

Default Gateway:

DNS Server:

Obtain DNS server address automatically

Set DNS server address manually

Preferred DNS server:

Alternate DNS server:

---

Network Transfer Rate:  KBps

## 12. Network Settings

Item	Description
IP Installer	<p>The B030-008-17-IP includes an IP Installer application that allows Windows computers to easily view and edit the KVM's network settings. This section determines what access the IP Installer has to the KVM switch.</p> <ul style="list-style-type: none"> <li>• Enabled – When selected, the IP Installer can locate the KVM switch on the network and display its current IP address. It also allows the IP Installer to be used to change the KVM's IP address.</li> <li>• View Only – When selected, the IP Installer can locate the KVM switch on the network and display its current IP address, but it cannot be used to change the KVM's IP address.</li> <li>• Disabled – When selected, the IP Installer cannot locate the KVM switch on the network, nor can it be used to change the KVM's IP address.</li> </ul>
Service Ports	<p>This section sets up port numbers allowed by a firewall. If the port numbers on this page are not allowed access by the firewall, you will not be able to access the KVM switch. Valid entries for all service ports are from 1 to 65535.</p> <p><b>Note:</b> A different port number must be entered for each field. If the KVM is connected to a network without a firewall, it doesn't matter what these ports are set to, as they will have no effect.</p> <ul style="list-style-type: none"> <li>• Program – This is the port number used when accessing connected computers via browser and non-browser Windows and Java clients. The default value is 9000. <b>Note:</b> This port number must match the port number for non-browser Windows and Java clients when using to connect to the KVM switch.</li> <li>• HTTP – This is the port used for a browser login. The default value is 80.</li> <li>• HTTPS – This is the port that is used for a secure browser login. The default is 443.</li> </ul>
IPv4 Settings	<p><b>If using an IPv6 IP address, ignore this section.</b></p> <ul style="list-style-type: none"> <li>• Obtain an IP Address Automatically (DHCP) – When this option is checked, the KVM switch will have its IP address assigned by a DHCP server upon booting up and the remaining fields will be grayed out. This option is checked by default.</li> <li>• Set IP Address Manually (Fixed IP) – Check this option to manually assign an IP address to the KVM. When checked, the settings fields below will be activated for you to edit.</li> <li>• IP Address – Enter the desired IP address here.</li> <li>• Subnet Mask – Enter the desired Subnet Mask here.</li> <li>• Default Gateway – Enter the desired Default Gateway here.</li> <li>• Obtain DNS Server Address Automatically – When this option is checked, the KVM switch will have its DNS Server address assigned by a DHCP server upon booting up and the remaining fields in this section will be grayed out. If you selected to set the IP address manually, this option will be grayed out and you will be required to enter the DNS Server address manually.</li> <li>• Set DNS Server Address Manually – Check this option to manually assign a DNS Server address to the KVM. When checked, the settings fields will be activated for editing.</li> <li>• Preferred DNS Server – Enter the preferred DNS Server address here.</li> <li>• Alternate DNS Server – Enter the alternate DNS Server address here. This is an optional field.</li> </ul>
IPv6 Settings	<p><b>If using an IPv4 IP address, ignore this section.</b></p> <ul style="list-style-type: none"> <li>• Obtain IPv6 Address Automatically (DHCP) – When this option is checked, the KVM switch will have its IP address assigned by a DHCP server upon booting up and the remaining fields in this section will be grayed out. This option is checked by default.</li> <li>• Set IPv6 Address Manually (Fixed IP) – Check this option to manually assign an IP address to the KVM. When checked, the settings fields below will be activated for editing.</li> <li>• IPv6 Address – Enter the desired IP address here.</li> <li>• Subnet Prefix Length – Enter the desired Subnet Prefix length here.</li> <li>• Default Gateway – Enter the desired Default Gateway here.</li> <li>• Obtain DNS Server Address Automatically – When this option is checked, the KVM switch will have its DNS Server address assigned to it by a DHCP server upon booting up and the remaining fields in this section will be grayed out. If you selected to set the IP address manually, this option will be grayed out and you will be required to enter the DNS Server address manually.</li> <li>• Set DNS Server Address Manually – Check this option to manually assign a DNS Server address to the KVM. When checked, the settings fields will be activated for editing.</li> <li>• Preferred DNS Server – Enter the preferred DNS Server address here.</li> <li>• Alternate DNS Server – Enter the alternate DNS Server address here. This is an optional field.</li> </ul>
Network Transfer Rate	<p>This setting sets the size of the data transfer stream to match your network by setting the rate at which the KVM transfers data to remote computers. The range is from 4 to 99,999 Kbps. The default is 99999.</p>

After making any network changes, be sure *Reset on exit* on the *Maintenance* → *System Operation* page has been enabled (its corresponding box is checked), before logging out. This allows network changes to take effect without having to power the switch off.

## 12. Network Settings

### 12.1 Advanced Network Management Settings (ANMS)

The Advance Network management Settings (ANMS) are used to set up login authentication and authorization management from external sources. It is split up into two pages; Event Destination and Authentication.

#### Event Destination

The Event Destination page allows the KVM to be set up to record and send notifications of events that take place on the system. With this page, users can enable and set up notifications via SMTP, SNMP, Syslog Server and the Log Server.

The screenshot displays a configuration interface for Event Destination settings, organized into four sections:

- SMTP Settings:** Includes a checkbox for "Enable report from the following SMTP Server". Below it are fields for "SMTP Server:", "Service Port:" (with a default value of 25), and checkboxes for "My server requires secure connection (SSL)" and "My server requires authentication". Further down are fields for "Account Name:", "Password:", "From:", and "To:".
- Log Server:** Includes a checkbox for "Enable", a "MAC Address:" field (with a default value of 000000000000), and a "Service Port:" field (with a default value of 9001).
- SNMP Server:** Includes a checkbox for "Enable SNMP Agent", a "Server IP:" field, and a "Service Port:" field (with a default value of 162).
- Syslog Server:** Includes a checkbox for "Enable", a "Server IP:" field, and a "Service Port:" field (with a default value of 514).

#### SMTP Settings

The SMTP Settings provide system events notifications emailed via the SMTP server. To set up this feature, follow the steps below.

1. Check *Enable report from the following SMTP Server* box.
2. In the *SMTP Server* field, enter the IPv4 address, IPv6 address or domain name of the SMTP server.
3. In the *Service Port* field, enter the port the Firewall will allow to be used to access the SMTP server. The valid port range is between 1 and 65535. The default port number is 25.

**Note:** The port number entered must not be the same as any of the ports entered into the Network sub-section (for more information, see the **Network section in 11.12.2 Device Management.**)

4. If your server requires a secure SSL connection, check the *My server requires secure connection (SSL)* box.
5. If your server requires authentication, check the *My server requires authentication* box.
6. Enter the Account Name and Password for your SMTP server.
7. In the *From* field, enter the email address that you want the report to show up as being sent from.

**Note:** Only one email address is allowed in the *From* field and it cannot exceed 64 Bytes. 1 Byte is equal to 1 English alphanumeric character.

8. In the *To* field, enter the email address(es) to receive the report.

**Note:** When entering more than one address, separate them with a semicolon. The size of all email addresses cannot combine to more than 256 Bytes. 1 Byte is equal to 1 English alphanumeric character.

## 12. Network Settings

### Log Server

In addition to the OSD's built-in log, the KVM includes an external Windows-based log server that can be installed on a computer (refer to **17. Log Server** for details). The Log Server section on this page explains where the external log server can be enabled and set up for use. To do this, follow the steps below.

1. Check the *Enable* box.
2. In the *MAC Address* field, enter the MAC address of the computer the log server resides on.
3. In the *Service Port* field, enter the port the Firewall will allow to be used to access the log server. The valid port range is between 1 and 65535. The default port number is 9001.

**Note:** The port number entered must not be the same as any of the ports entered into the Network sub-section (for more information, see the **Network section in 11.12.2 Device Management**.)

### SNMP Server

To enable SNMP traps, follow the steps below.

1. Check the *Enable SNMP Agent* box.
2. In the *Server IP* field, enter the IPv4 address, IPv6 address or computer domain name to be notified of SNMP trap events.
3. In the *Service Port* field, enter the port the Firewall will allow to be used to access the SNMP server. The valid port range is between 1 and 65535. The default port number is 162.

**Note:** The port number entered must not be the same as any of the ports entered into the Network sub-section (for more information, see the **Network section in 11.12.2 Device Management**.)

### Syslog Server

To record all the events that take place on the KVM and write them to a Syslog server, follow the steps below.

1. Check the *Enable* box.
2. In the *Server IP* field, enter the IPv4 address, IPv6 address or domain name of the Syslog server.
3. In the *Service Port* field, enter in a port that the firewall will allow to be used to access the Syslog server. The valid port range is between 1 and 65535. The default port number is 514.

**Note:** The port number entered must not be the same as any of the ports entered into the Network sub-section (for more information, see the **Network section in 11.12.2 Device Management**.)

### Authentication

The Authentication page allows remote authentication setup via RADIUS and LDAP/S.

The screenshot shows the 'Authentication' configuration page. At the top, there is a checkbox labeled 'Disable Device Authentication'. Below this, the 'RADIUS Settings' section is expanded, showing an 'Enable' checkbox and several input fields: 'Preferred RADIUS Server IP', 'Preferred RADIUS Service Port', 'Alternate RADIUS Server IP', 'Alternate RADIUS Service Port', 'Timeout' (with a 'sec' label), 'Retries', and 'Shared Secret (at least 6 characters)'. The 'AD/LDAP Settings' section is also expanded, showing an 'Enable' checkbox, a 'Type' dropdown menu with 'LDAP' selected and 'LDAPS' as an option, and input fields for 'LDAP Server', 'Port', 'Admin DN', 'Admin Name', 'Password', 'Search DN', and 'Timeout' (with a 'sec' label).

### Disable Device Authentication

Check this box to disable local login authentication of the KVM switch. If checked, the switch can only be accessed using LDAP, LDAPS, MS Active Directory and/or RADIUS authentication.

## 12. Network Settings

### 12.1.1 RADIUS Settings

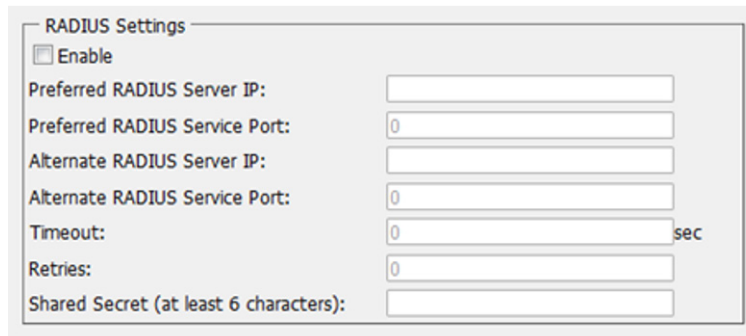

To allow authentication and authorization for B030-008-17-IP through a RADIUS server:

1. Check the *Enable* box in the RADIUS section.
2. Fill in the IP addresses and port numbers for the Preferred and Alternate RADIUS servers.
3. In the **Timeout** field, set the time in seconds that the KVM Switch waits for a RADIUS server reply before it times out.
4. In the **Retries** field, set the number of allowed RADIUS retries.
5. In the **Shared Secret** field, key in the character string to use for authentication between the KVM Switch and the RADIUS Server.
6. On the RADIUS server, Users can be authenticated with the following methods:
  - Set the entry for the user as su/xxx, where xxx represents the Username given when the account was created in the B030-008-17-IP User Management page.
  - Use the same Username on both the RADIUS server and the B030-008-17-IPIn each case, the user's access rights are those assigned in the User Management section of the B030-008-17-IP.
7. Click Save at the bottom of the screen to save all of the settings.

### 12.1.2 Configuring RADIUS Authentication

The following instructions show how to configure a Windows 2003 server with the B030-008-17-IP.

**Note:** These steps were taken on a Windows 2003 server with the Internet Authentication Service (IAS) component installed.

**B030-008-17-IP**

**IP: 10.0.1.193**

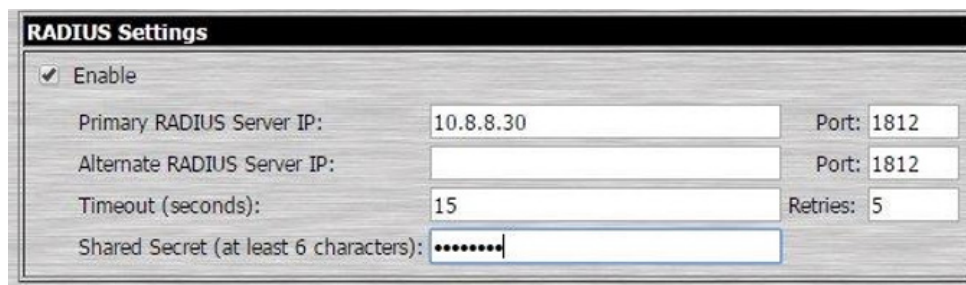

**Note:** The Shared Secret will be used in communication with the RADIUS server. Only one RADIUS server is used in this scenario so the primary and alternative RADIUS servers are assigned the same settings.

## 12. Network Settings

Win2K3

IP: 10.8.8.30

1. Start the Microsoft Management Console (MMC) and add the Internet Authentication Service by choosing *Add/Remove Snap-in* from the console menu. Click *Add* and select the IAS Snap-in. Choose the Local Computer.

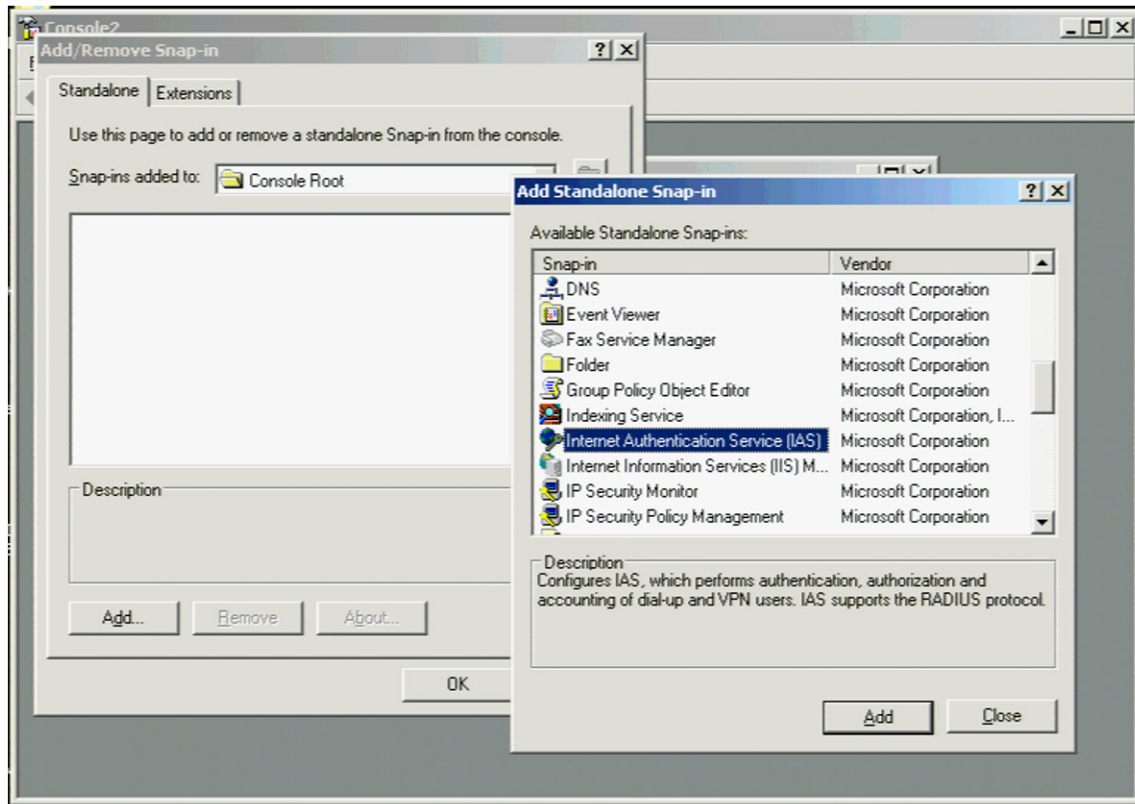

Or go to: Start > Programs > Administrative Tools > Internet Authentication Service.

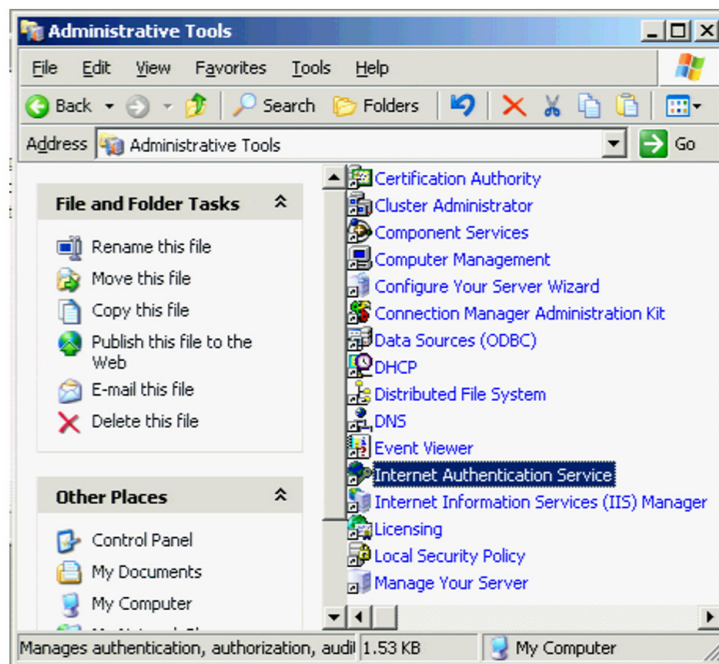

## 12. Network Settings

2. Create a rule to allow the Access Gateway access to the RADIUS server.

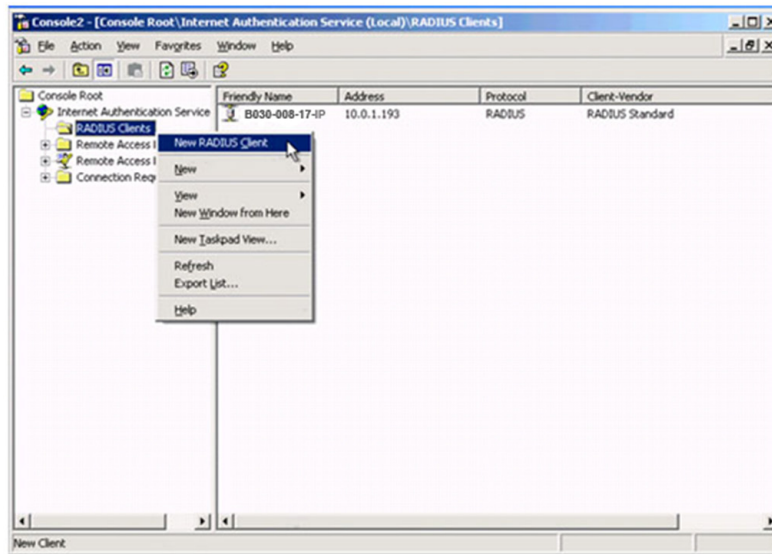

The 'New RADIUS Client' dialog box is shown with the 'Name and Address' tab selected. The instructions state: 'Type a friendly name and either an IP Address or DNS name for the client.'

Fields and values:

- Friendly name: B030-008-17-IP
- Client address (IP or DNS): 10.0.1.193

A 'Verify...' button is located to the right of the client address field. At the bottom, there are '< Back', 'Next >', and 'Cancel' buttons.

The 'New RADIUS Client' dialog box is shown with the 'Additional Information' tab selected. The instructions state: 'If you are using remote access policies based on the client vendor attribute, specify the vendor of the RADIUS client.'

Fields and values:

- Client-Vendor: RADIUS Standard (selected in a dropdown menu)
- Shared secret: [Redacted]
- Confirm shared secret: [Redacted]

An unchecked checkbox is labeled 'Request must contain the Message Authenticator attribute'. At the bottom, there are '< Back', 'Finish', and 'Cancel' buttons.

**Note:** The Shared Secret is the same one used when configuring the B030-008-17-IP.



## 12. Network Settings

3. Create a New Remote Access Policy and click Next.

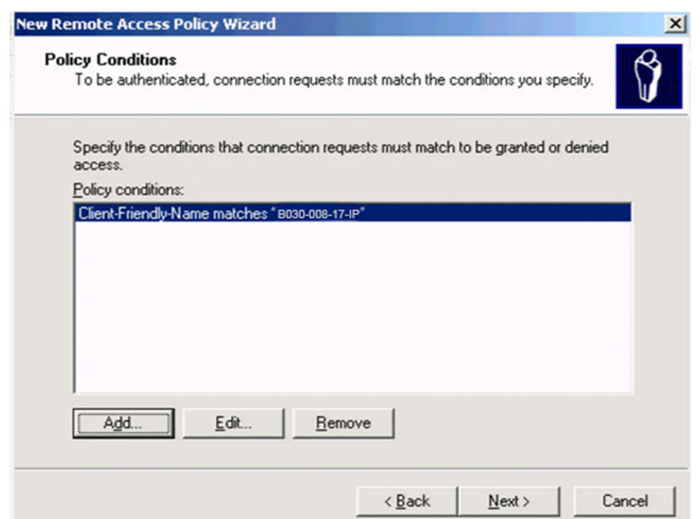
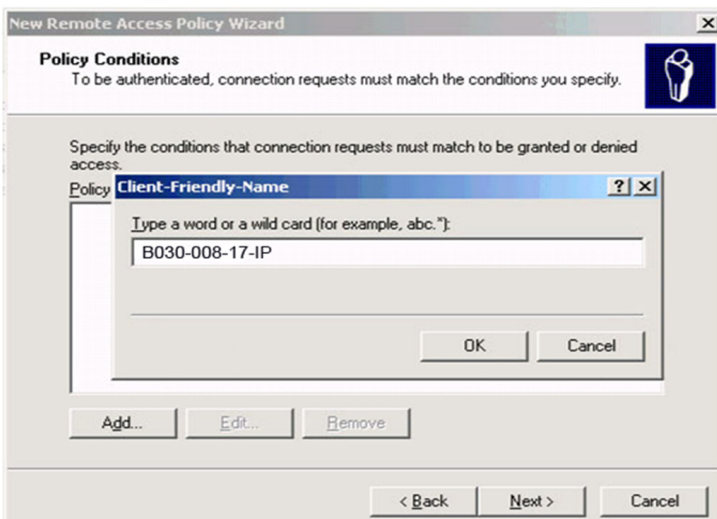
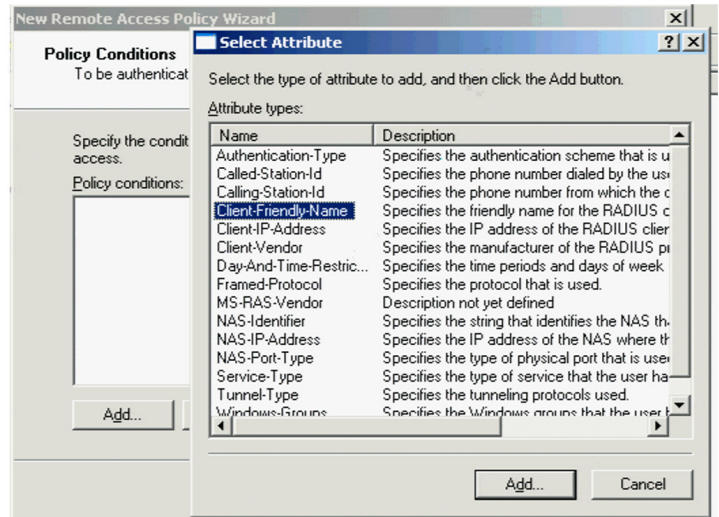
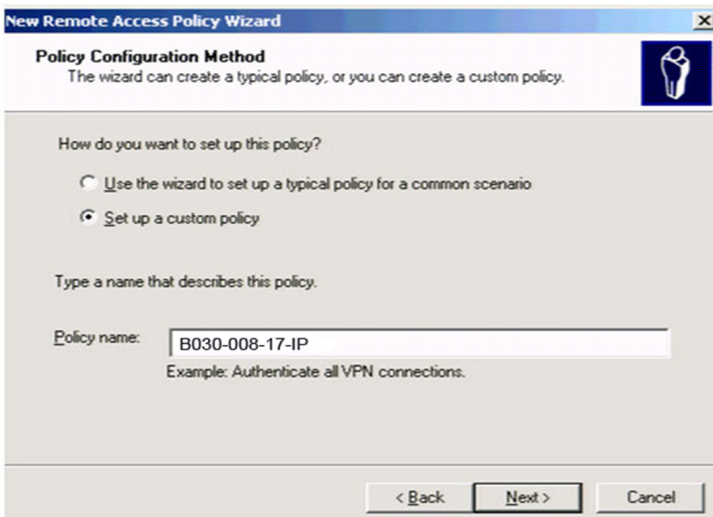
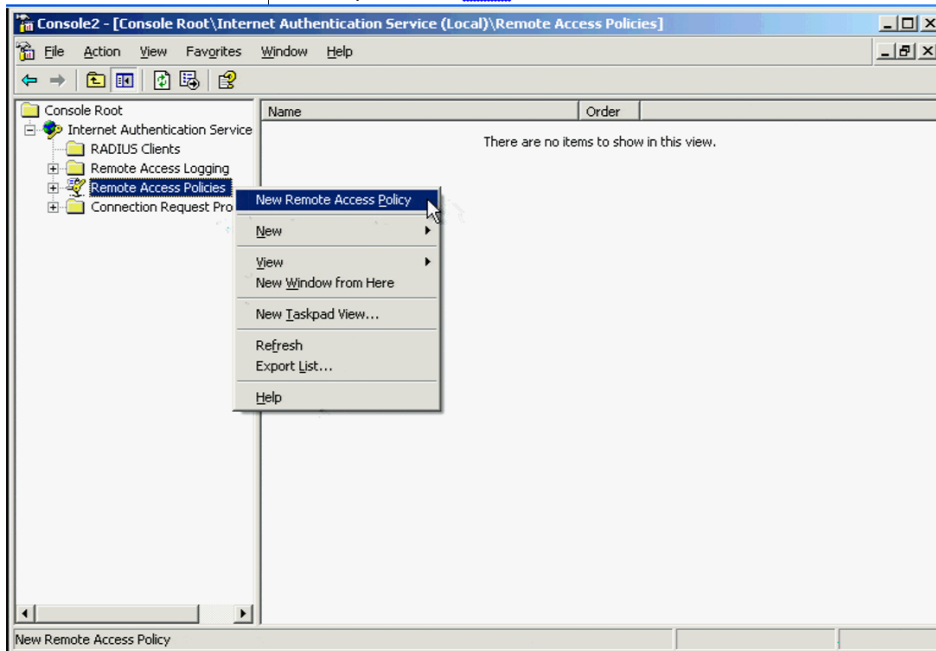

## 12. Network Settings

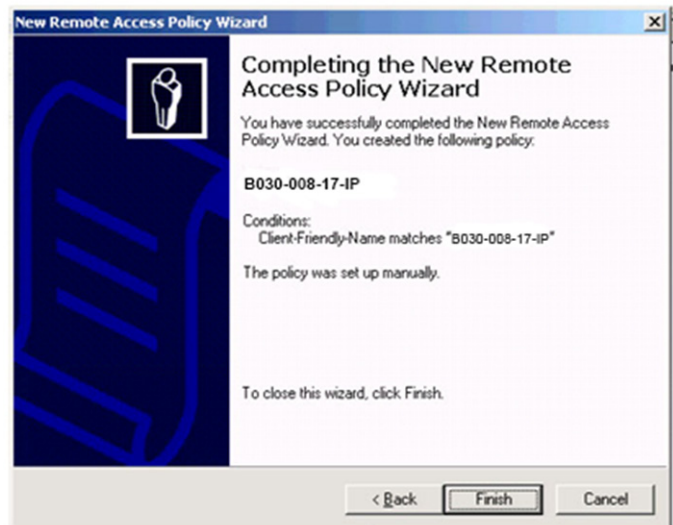
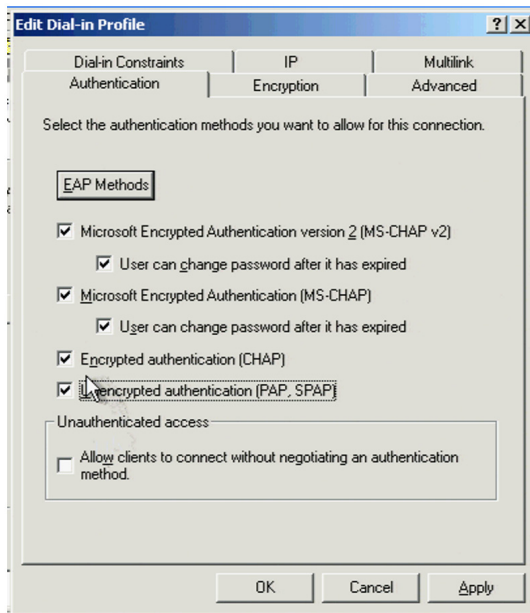
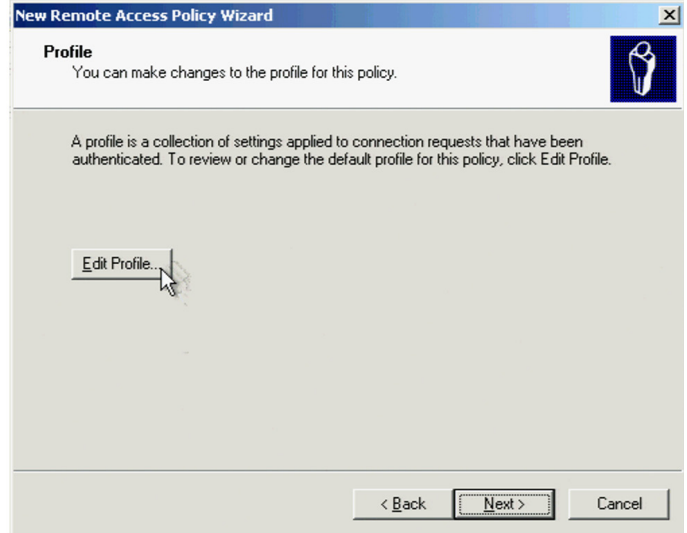
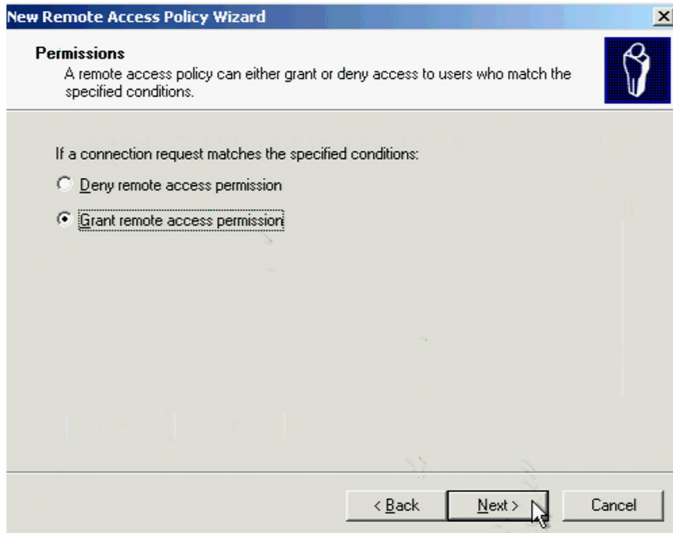

# 12. Network Settings

4. Create an Access Control List Policy (one policy per user).

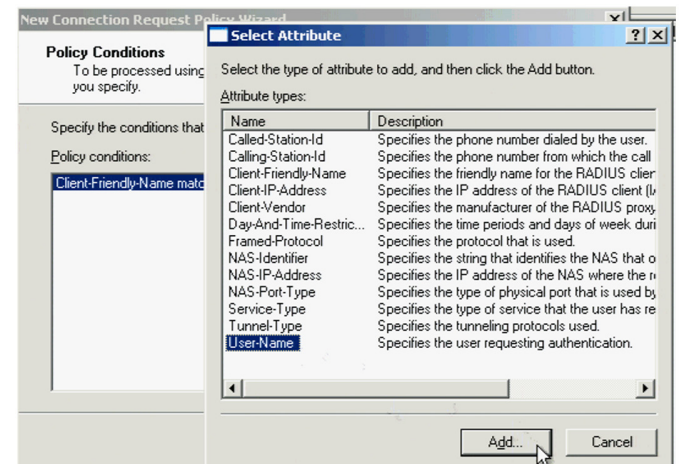
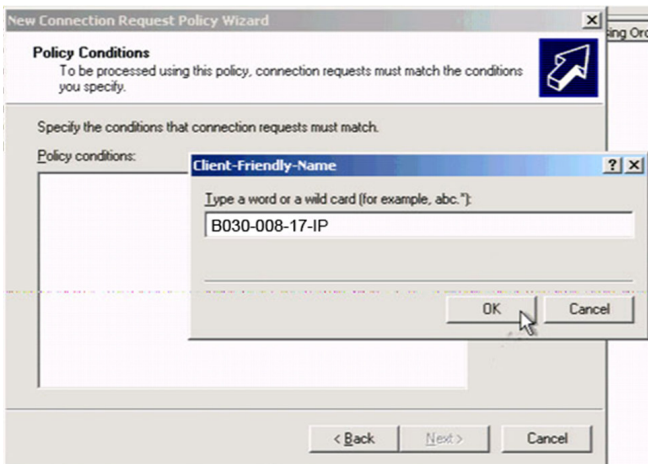
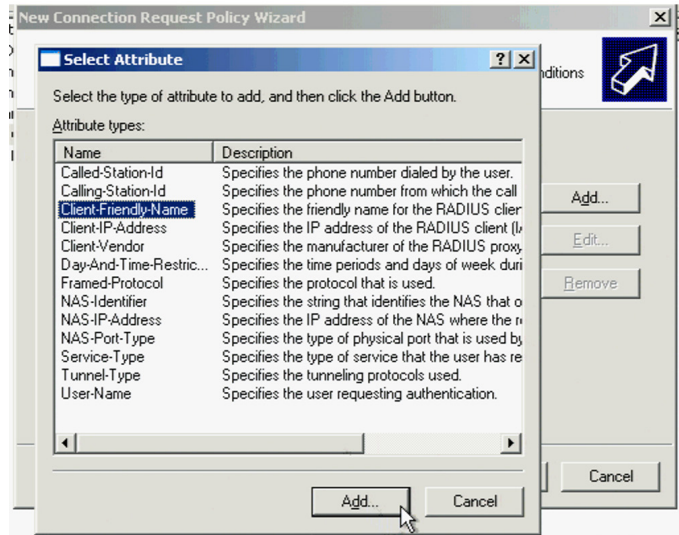
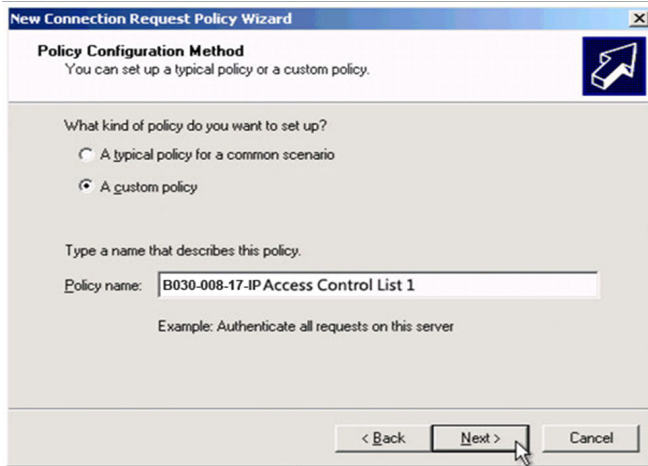
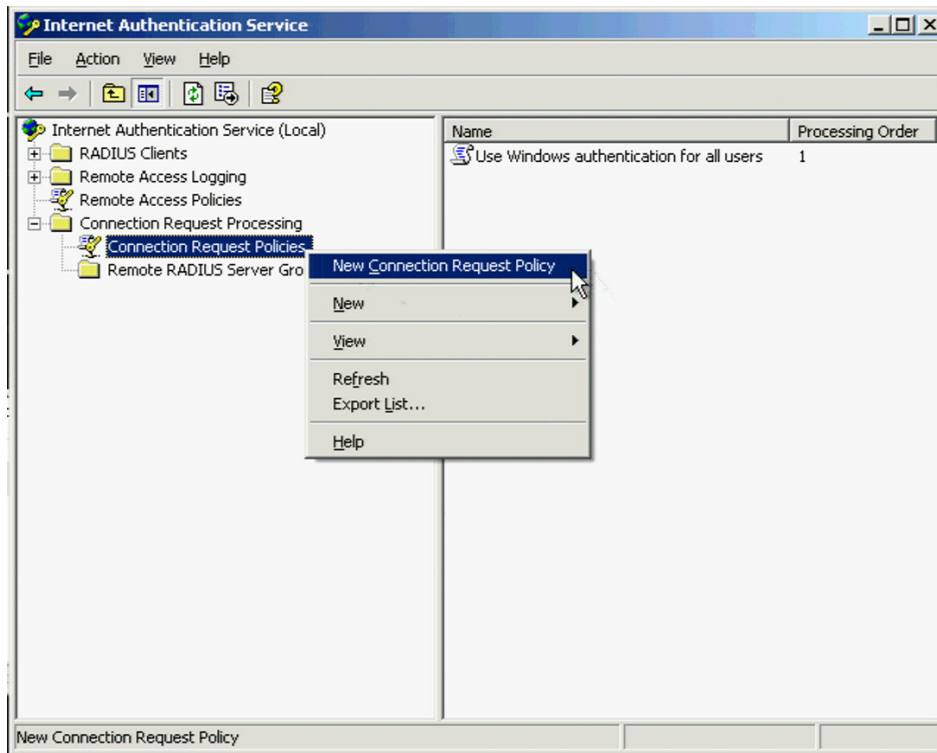

# 12. Network Settings

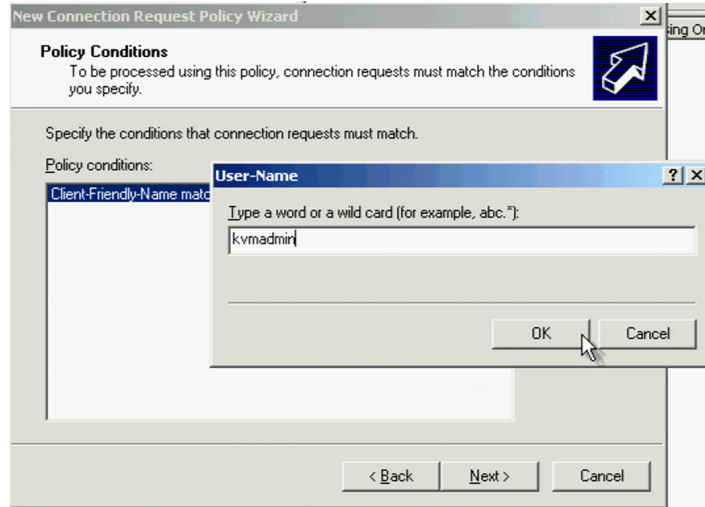

Note: kvadmin is a user created in Win2K3 in advance.

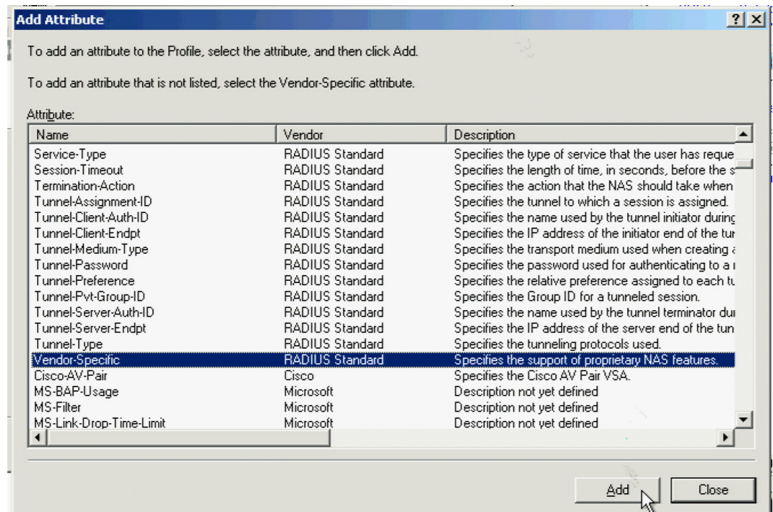
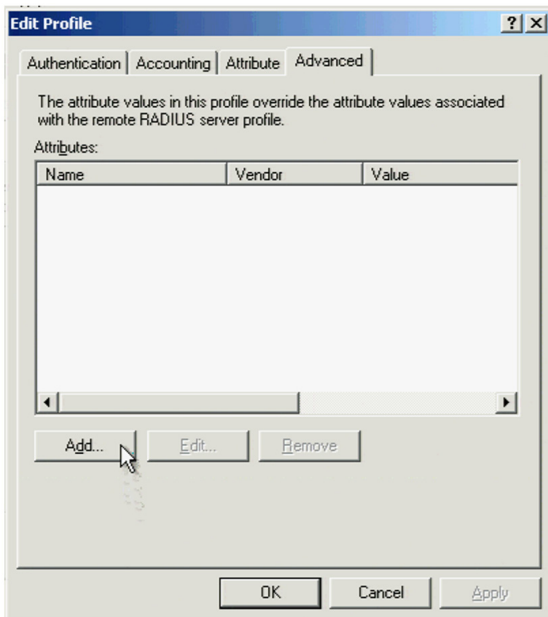
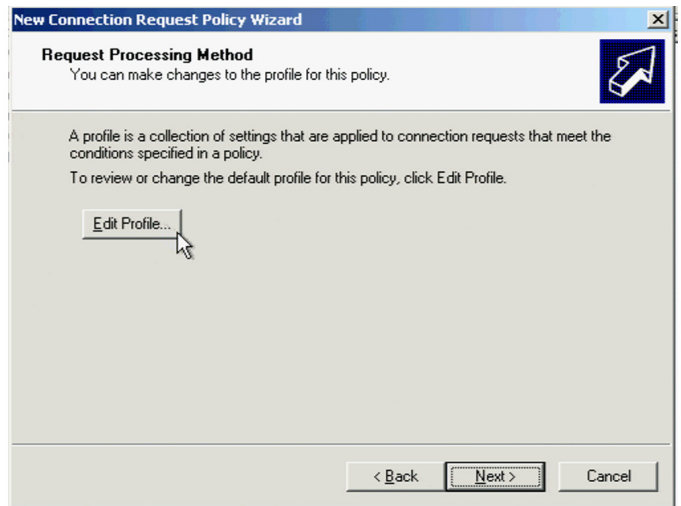
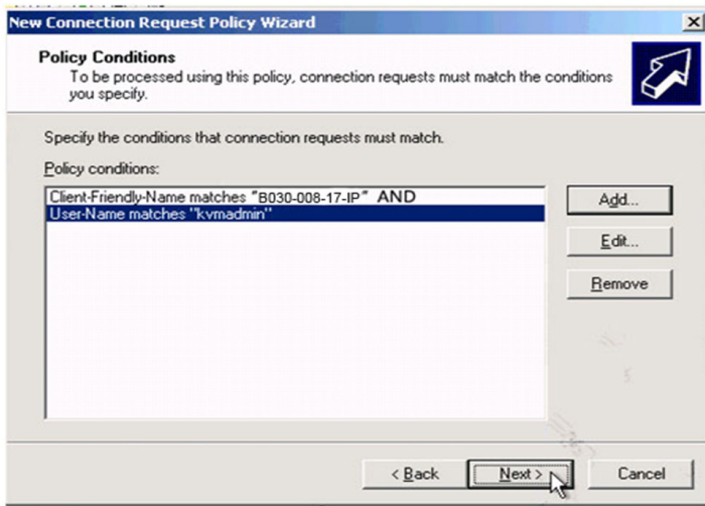

## 12. Network Settings

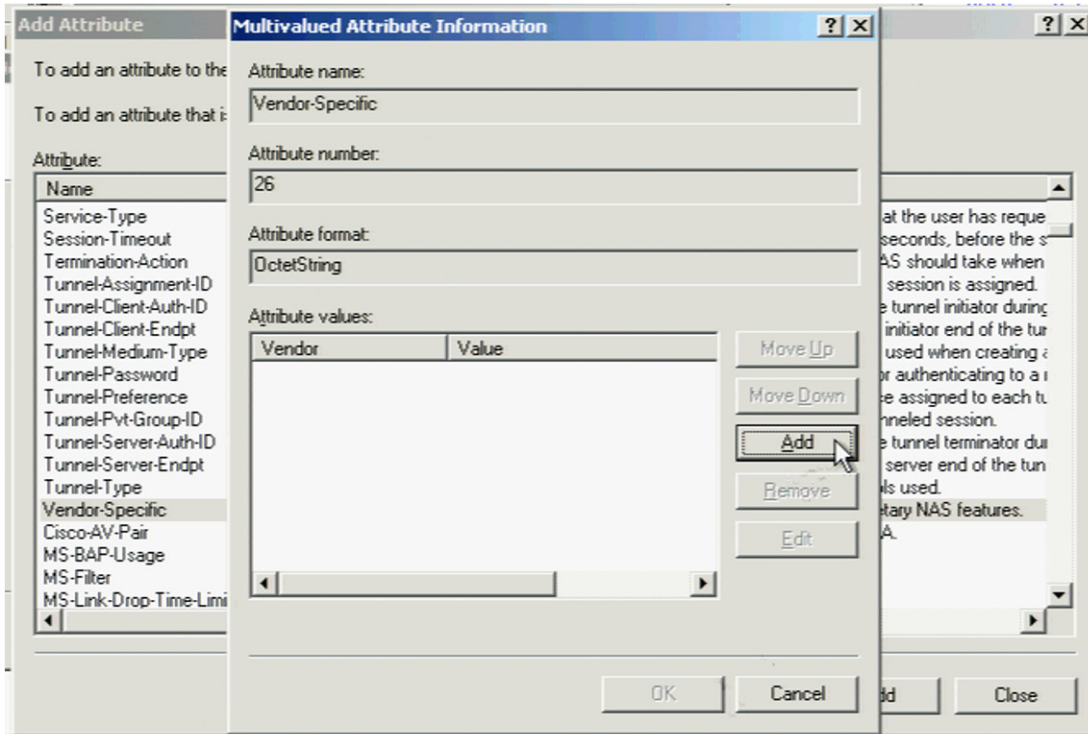

Click *Configure Attribute*. In the screen that appears, set the entry for the user as **su/xxxx**, where xxxx represents the Username given when the account was created in the B030-008-17-IP User Management page. User access rights will be the same as those assigned to the KVM switch (refer to **11.12 User Management** for more information).

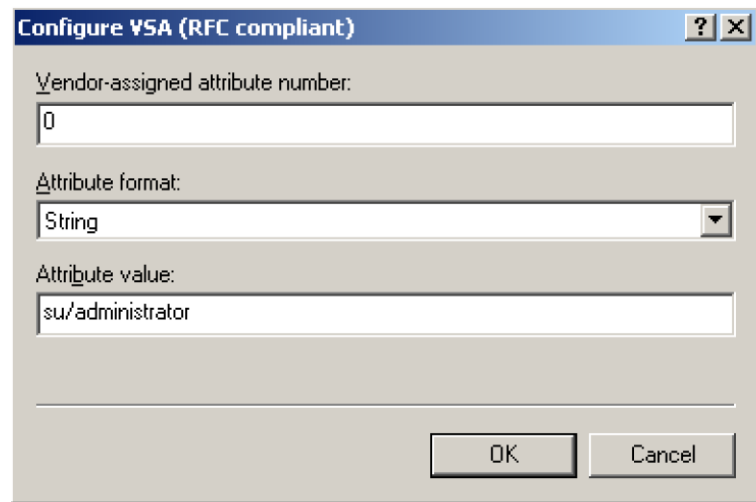
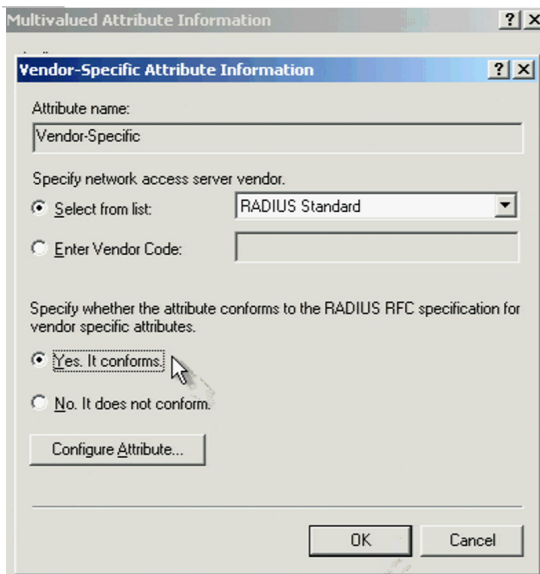

Repeat as needed to set the B030-008-17-IP Access Control List Policy for other users.

## 12. Network Settings

### 12.2 LDAP / LDAPS Authentication and Authorization Settings

AD/LDAP Settings

Enable

Type

LDAP  LDAPS

LDAP Server:  Port:  0

Admin DN:  Timeout:  0 sec

Admin Name:

Password:

Search DN:

To allow authentication and authorization for the B030-008-17-IP via LDAP / LDAPS:

Item	Description
Enable	Check the Enable box to allow LDAP / LDAPS authentication and authorization.
LDAP / LDAPS	Click to specify whether to use LDAP or LDAPS.
LDAP Server IP and Port	Fill in the IP address and port number for the LDAP or LDAPS server. For LDAP, the default port number is 389; for LDAPS, the default port number is 636.
Timeout	Set the time in seconds that the KVM Switch waits for an LDAP or LDAPS server reply before it times out.
Admin DN	Consult the LDAP / LDAPS administrator to determine the appropriate entry for this field. For example, the entry might look like: ou=b030-008-017-ip,dc=tripplite,dc=com
Admin Name	Enter the LDAP administrator's username.
Password	Enter the LDAP administrator's password.
Search DN	Set the name of the search base. This is the domain name where searches begin for user names.

Click Save at the bottom of the screen to save all settings.

**Note:** If the LDAP Setting is enabled, the LDAP schema for MS Active Directory must be extended, or an OpenLDAP server must be installed and configured. Refer to LDAP Server Configuration in the following section for details.

#### 12.2.1 LDAP Configuration — Active Directory

To allow authentication and authorization for the KVM Switch via LDAP or LDAPS, the Active Directory's LDAP Schema must be extended so that an extended attribute name for the KVM Switch – **userprofile** – is added as an optional attribute to the person class.

- Authentication refers to determining the authenticity of the person logging in.
- Authorization refers to assigning permission to use the device's various features.

In order to configure the LDAP server, complete the following procedures: 1) Install the Windows 2003 Support Tools; 2) Install the Active Directory Schema Snap-in; and 3) Extend and Update the Active Directory Schema.

##### Install the Windows 2003 Support Tools

1. On your Windows Server CD, open the Support → Tools folder.
2. In the right panel of the dialog box that appears, double-click *SupTools.msi*.
3. Follow along with the Installation Wizard to complete the procedure.

##### Install the Active Directory Schema Snap-in

1. Open a Command Prompt.
2. Enter **regsvr32 schmmgmt.dll** to register schmmgmt.dll on your computer.
3. Open the Start menu. Click *Run* and enter **mmc /a**. Click *OK*.
4. On the File menu of the screen that appears, click *Add/Remove Snap-in*, then click *Add*.
5. Under Available Standalone Snap-ins, double-click *Active Directory Schema*, click *Close*, then click *OK*.
6. From the existing screen, open the File menu and click *Save*.
7. For Save in, specify the **C:\Windows\system32** directory.
8. For File name, enter **schmmgmt.msc**.
9. Click *Save* to complete the procedure.

## 12. Network Settings

### Creating a Start Menu Shortcut Entry

1. Right click *Start*; select: *Open all Users* → *Programs* → *Administrative Tools*.
2. On the *File* menu, select *New* → *Shortcut*
3. In the dialog box that appears, browse to or enter in the path to *schmmgmt.msc* (**C:\Windows\system32\schmmgmt.msc**) and click *Next*.
4. In the dialog box that appears, enter **Active Directory Schema** as the name for the shortcut, then click *Finish*.

### 12.2.2 Extend and Update the Active Directory Schema

#### Step 1 - Create a New Attribute:

- a) Open *Control Panel* → *Administrative Tools* → *Active Directory Schema*.

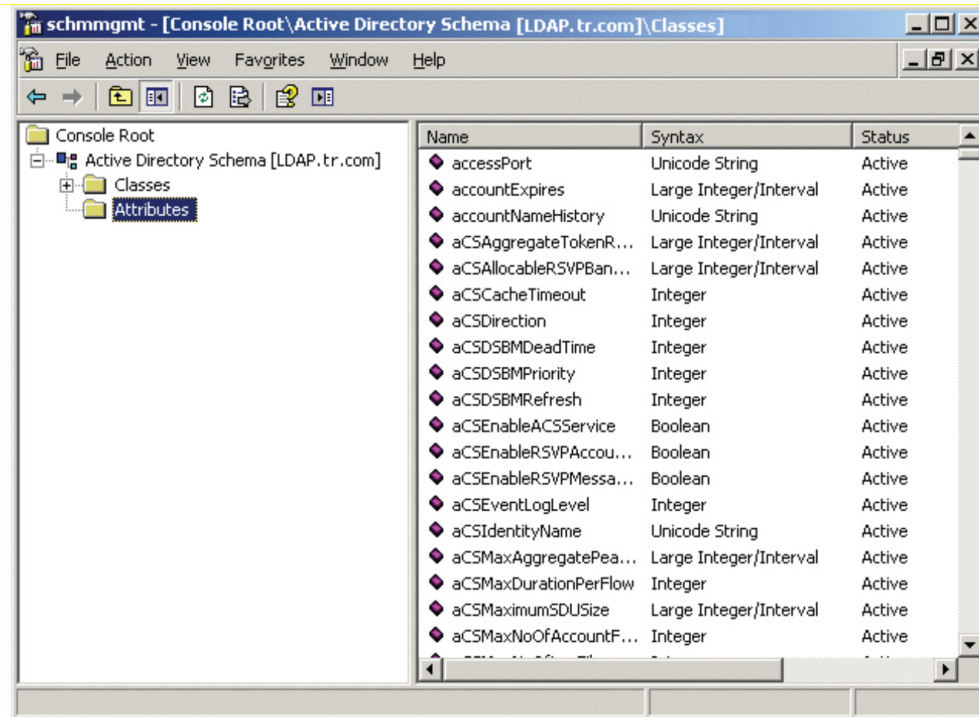

- b) In the left panel of the screen that appears, right-click *Attributes*:
- c) Select *New* → *Attribute*.
- d) In the warning message that appears, click *Continue* to open the Create New Attribute dialog box.

## 12. Network Settings

e) Fill in the dialog box according to the example below and click OK.

- Common Name – userprofile
- LDAP Display Name – userprofile
- Syntax – Unicode String
- Minimum – 1
- Maximum – 255

**Note:** The Unique X500 Object ID uses periods, not commas.

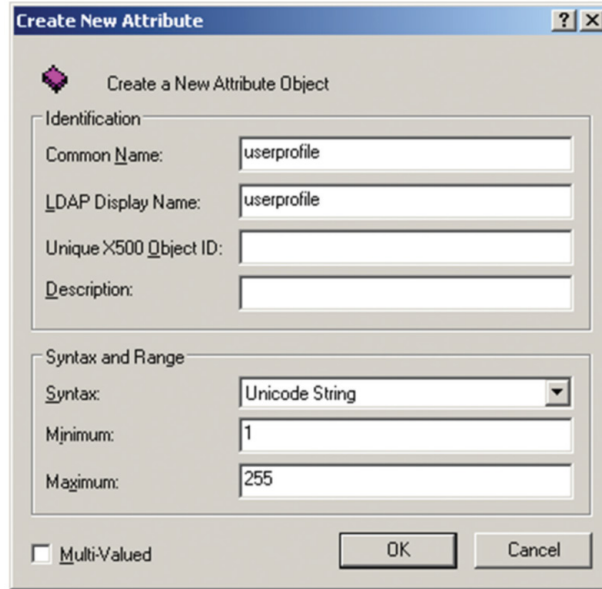

**Create New Attribute**

Create a New Attribute Object

Identification

Common Name: userprofile

LDAP Display Name: userprofile

Unique X500 Object ID:

Description:

Syntax and Range

Syntax: Unicode String

Minimum: 1

Maximum: 255

Multi-Valued

OK Cancel

### Step 2 - Extend the Object Class with the New Attribute:

- Open Control Panel → Administrative Tools → Active Directory Schema.
- In the left panel of the screen that appears, select **Classes**.
- In the right panel, right-click on the user account name:

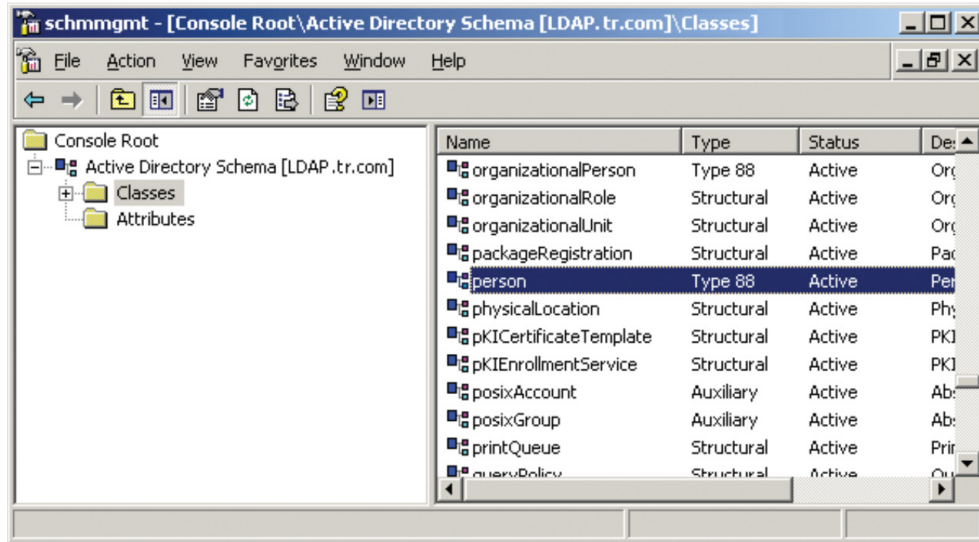



## 12. Network Settings

d) Select *Properties*; the user's Properties page will appear with the General tab displayed.

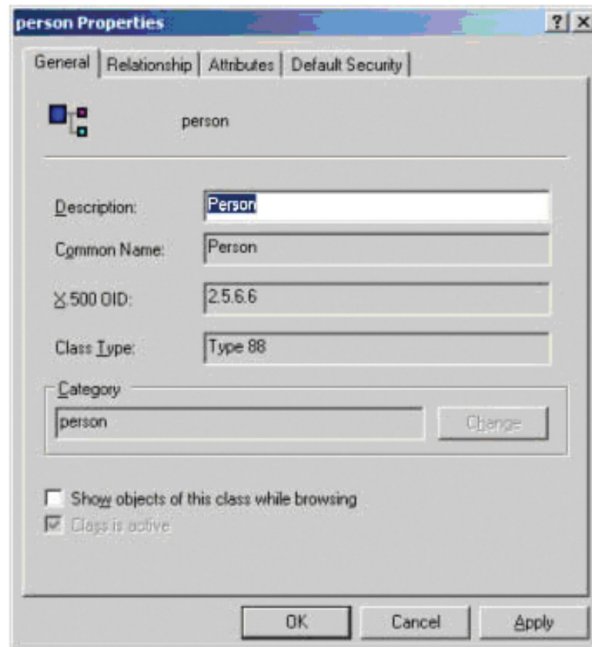

e) Select the Attributes tab and click *Add*:

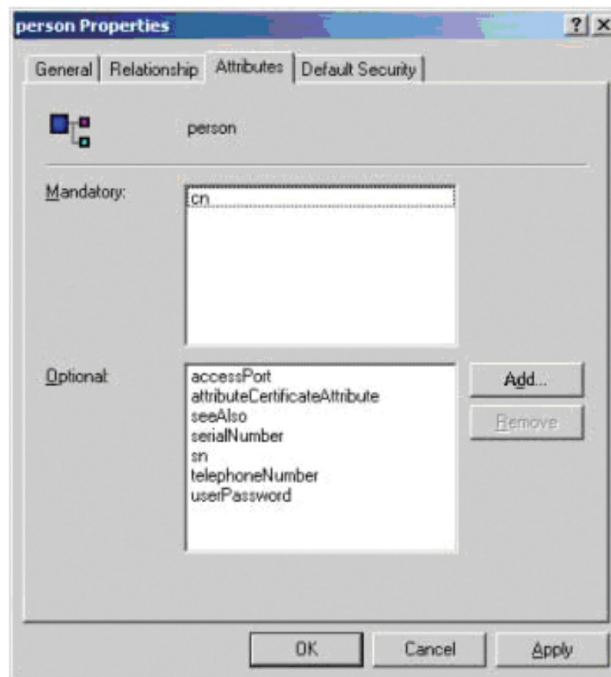

## 12. Network Settings

f) In the list that appears, select *userprofile*, then click *OK*.

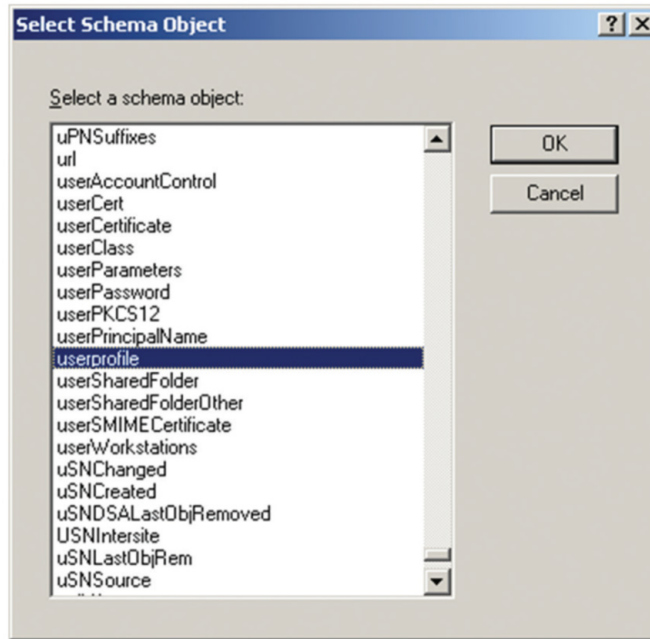

### Step 3 - Edit Active Directory Users with the Extended Schema:

- Run ADSI Edit (installed as part of Support Tools.)
- Open Domain and navigate to the *cn=users dc=tripplite dc=com* node.
- Locate the user you wish to edit.

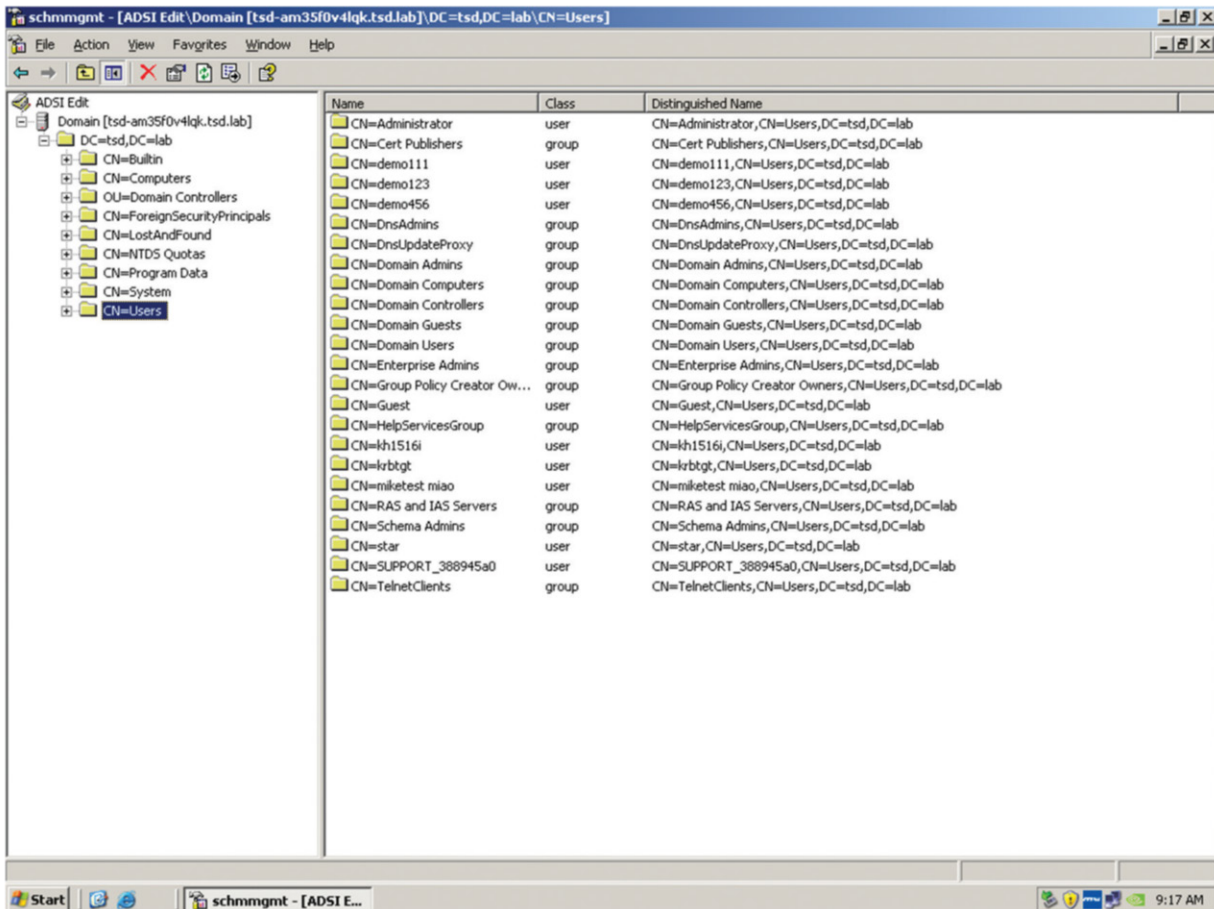

## 12. Network Settings

- d) Right-click on the user's name and select *Properties*.
- e) On the Attribute Editor page of the dialog box that appears, select *userprofile* from the list.

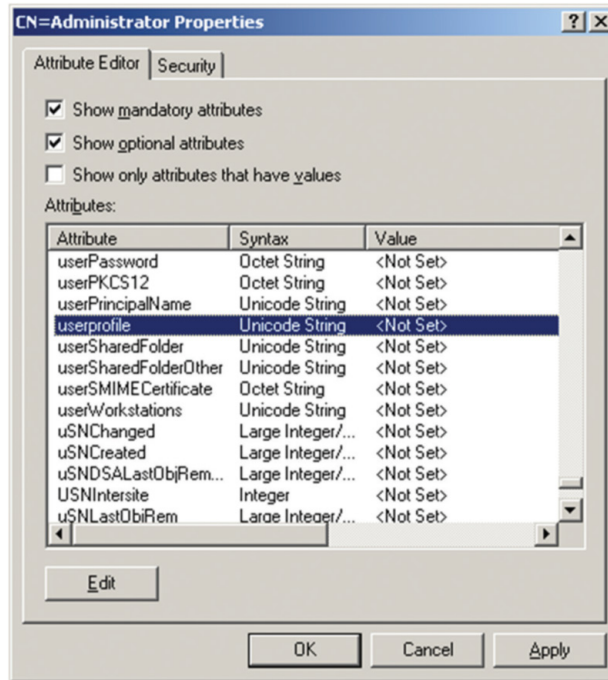

- f) Click *Edit* to access the String Attribute Editor:

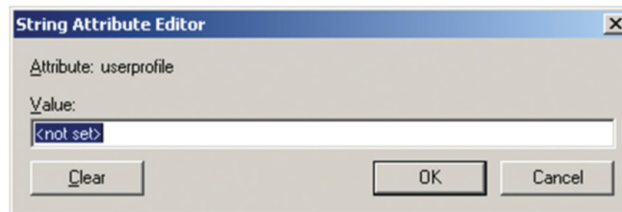

- g) Replace the value shown with `su/xxx`, where `xxx` represents the username assigned to the user in the KVM switch. User access rights will be the same as those assigned to them in the KVM switch (refer to **12.1 User Management** for details).
- h) Click *OK*. When you return to the Attribute Editor page, the *userprofile* entry will reflect the new permissions:

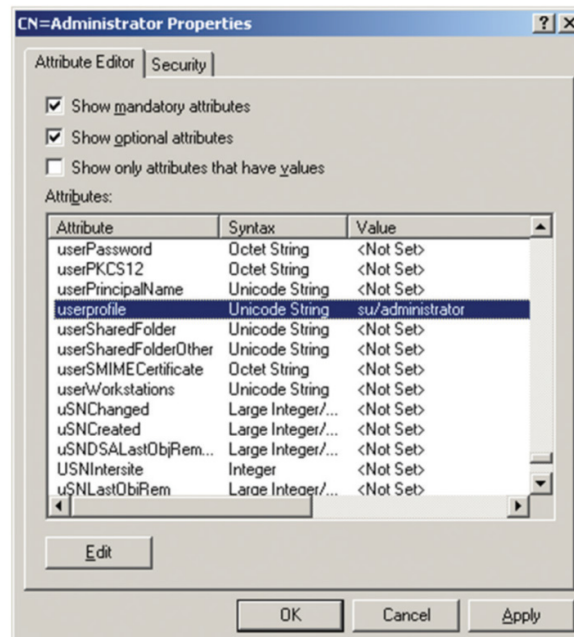

## 12. Network Settings

- i) Click *Apply* to save the change and complete the procedure.
- j) Repeat Step 3 (**Edit Active Directory Users with the Extended Schema**) to add any additional users.

### 12.3 OpenLDAP Server Installation

OpenLDAP is an open source LDAP server designed for UNIX platforms. A Windows version can be downloaded from: [http://download.bergmans.us/openldap/openldap-2.2.29/openldap-2.2.29-db-4.3.29-openssl-0.9.8awin32\\_Setup.exe](http://download.bergmans.us/openldap/openldap-2.2.29/openldap-2.2.29-db-4.3.29-openssl-0.9.8awin32_Setup.exe).

After downloading the program, launch the installer, select your language, accept the license and choose the target installation directory. The default directory is:

c:\Program Files\OpenLDAP.

When the Select Components dialog box appears, select *install BDB-tools* and install OpenLDAP-slapped as NT service:

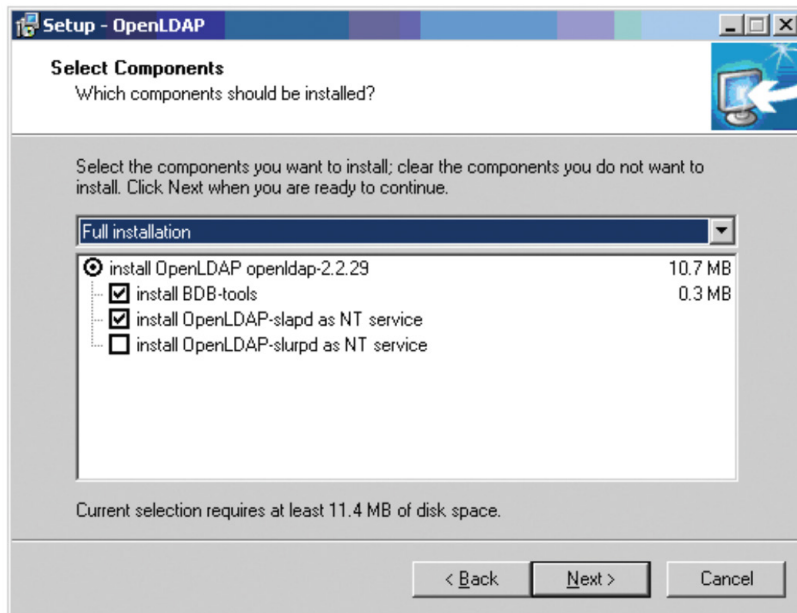

#### 12.3.1 OpenLDAP Server Configuration

The main OpenLDAP configuration file *slapd.conf* must be customized before launching the server. The modifications to the configuration file will:

- Specify the Unicode data directory. The default is ***.ucdata***.
- Choose the required LDAP schemas. The core schema is mandatory.
- Configure the path for the OpenLDAP pid and args start-up files. The first contains the server **pid**, the second includes command line arguments.
- Choose the database type. The default is **bdb** (Berkeley DB).
- Specify the server suffix. All entries in the directory will have this suffix, which represents the root of the directory tree. For example, with suffix *dc=tripplite,dc=com*, the fully qualified name of all entries in the database will end with *dc=tripplite,dc=com*.
- Define the name of the administrator entry for the server (*rootdn*), along with its password (*rootpw*). This is the server's super user. The *rootdn* name must match the suffix defined above. Since all entry names must end with the defined suffix, and the *rootdn* is an entry.

## 12. Network Settings

An example configuration file will appear as:

```
ucdata-path ./ucdata
include ./schema/core.schema

pidfile ./run/slapd.pid
argsfile ./run/slapd.args

database bdb
suffix "dc=tripplite,dc=com"
rootdn "cn=Manager, dc=tripplite,dc=com"
rootpw secret
directory ./data
```

### 12.3.2 Starting the OpenLDAP Server

To start the OpenLDAP Server, run `slapd` (the OpenLDAP Server executable file) from the command line. `slapd` supports a number of command line options, the most important option is the `d` switch that triggers debug information. For example, a command of `slapd -d 256` would start OpenLDAP with a debug level of 256, as shown in the following screenshot:

**Note:** For details about `slapd` options and their meanings, refer to the OpenLDAP documentation.

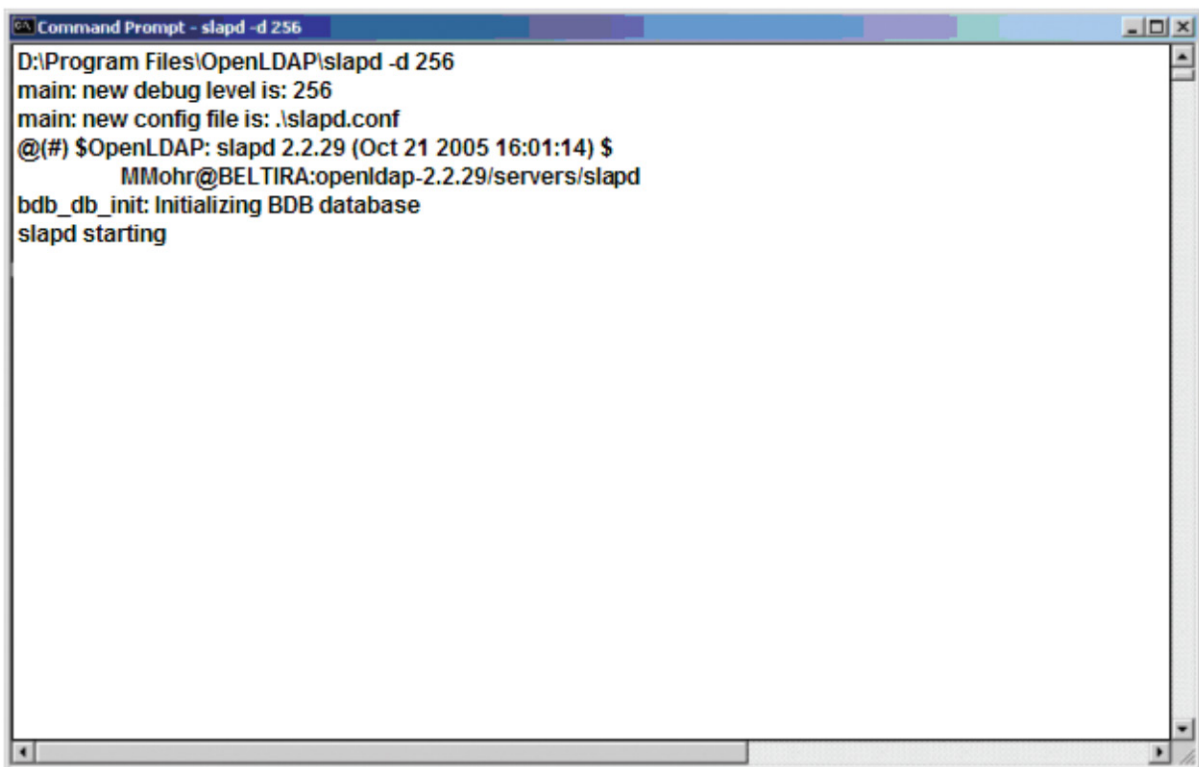

```
Command Prompt - slapd -d 256
D:\Program Files\OpenLDAP\slapd -d 256
main: new debug level is: 256
main: new config file is: .\slapd.conf
@(#) $OpenLDAP: slapd 2.2.29 (Oct 21 2005 16:01:14) $
MMohr@BELTIRA:openldap-2.2.29/servers/slapd
bdb_db_init: Initializing BDB database
slapd starting
```

## 12. Network Settings

### 12.3.3 Customizing the OpenLDAP Schema

The schema that slapd uses may be extended to support additional syntaxes, matching rules, attribute types, and object classes. In the case of the B030-008-17-IP, the User class and the permission attribute are extended to define a new schema. The extended schema file used to authenticate and authorize users logging in to the KVM Switch is shown in the figure below:

```
#####  
##  
##  
## Copyright (C) 2008 TrippLite  
## All Rights Reserved.  
## Author: Judy  
## Date: November 27, 2008  
## Summary: Define the LDAP schema  
##  
##  
#####  
#  
# TRIPPLITE OID:={1.3.6.1.4.21317}  
#  
  
attributetype (1.3.6.1.4.1.21317.1.1.4.2.2  
    NAME 'permission'  
    EQUALITY caseIgnoreMatch  
    SUBSTR caseIgnoreSubstringsMatch  
    SYNTAX 1.3.6.1.4.1.1466.115.121.1.15  
    SINGLE-VALUE)  
  
objectclass (1.3.6.1.4.1.21317.1.1.4.1.2  
    NAME 'User'  
    SUP organizationalPerson  
    STRUCTURAL  
    MAY ('permission'$ userCertification
```

## 12.4 LDAP DIT Design and LDIF File

### 12.4.1 LDAP Data Structure

An LDAP Directory stores information in a tree structure known as the Directory Information Tree (DIT). The nodes in the tree are directory entries and each entry contains information in attribute-value form. An example of the LDAP directory tree for the B030-008-17-IP is shown in the figure below:

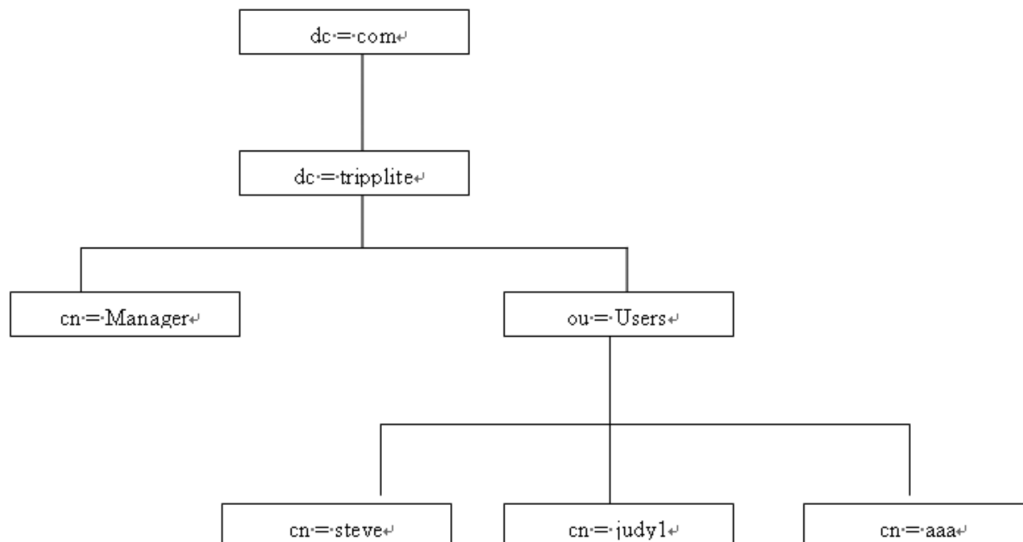

## 12. Network Settings

### 12.4.2 DIT Creation

The LDAP Data Interchange Format (LDIF) is used to represent LDAP entries in a simple text format (refer to RFC 2849). The figure below illustrates an LDIF file that creates the DIT for the B030-008-17-IP directory tree (shown in the figure in the previous section).

```
#####  
##  
##  
## Copyright (C) 2008 TrippLite  
## All Rights Reserved.  
## Author: Judy  
## Date: November 27, 2008  
## Summary: Define the LDAP schema  
##  
#####  
  
dn: dc=tripplite, dc=com  
objectclass: top  
objectClass: dcObject  
objectClass: organization  
  
dn: cn=Manager, dc=tripplite, dc=com  
objectclass: top  
objectclass: person  
objectclass: organizationalPerson  
cn: Manager  
sn: Manager  
  
dn: ou=Users, dc=tripplite, dc=com  
objectclass: top  
objectclass: organizationalUnit  
ou: Users  
  
dn: cn=steve, ou=Users, dc=tripplite, dc=com  
objectclass: top  
objectclass: person  
objectclass: organizationalPerson  
objectclass: User  
cn: steve  
sn: steve  
permission: w,v,p,j,c,l  
userPassword:password  
ou: Users
```

The following figure illustrates an LDIF file that defines the OpenLDAP group for the B030-008-17-IP

```
#####  
##  
##  
## Copyright (C) 2008 TrippLite  
## All Rights Reserved.  
## Author: Judy  
## Date: November 27, 2008  
## Summary: Define the LDAP schema  
##  
#####  
  
dn: cn=judy1, ou=Users, dc=tripplite, dc=com  
objectclass: top  
objectclass: person  
objectclass: organizationalPerson  
objectclass: User  
cn: judy1  
sn: judy1  
userPassword:password  
  
dn: cn=ccc, dc=tripplite, dc=com  
objectClass: groupOfNames  
cn: ccc  
member: cn=judy1, cn=users, dc=tripplite, dc=com  
  
dn: cn=bbb, dc=tripplite, dc=com  
objectClass: groupOfNames  
cn: bbb  
member: cn=ccc, dc=tripplite, dc=com  
  
dn: cn=aaa, dc=tripplite, dc=com  
objectClass: groupOfNames  
cn: aaa  
member: cn=bbb, dc=tripplite, dc=com
```

## 12. Network Settings

### 12.4.3 Using the New Schema

To use the new schema:

1. Save the new schema file (e.g., B030-008-17-IPschema) in the `/OpenLDAP/schema/` directory.
2. Add the new schema to the `slapd.conf` file, as shown in the figure below.

```
ucdata-path      ./ucdata
include          ./schema/core.schema
include          ./schema/cosine.schema
include          ./schema/inetorgperson.schema
include          ./schema/openldap.schema
include          ./schema/.schema
```

```
# Define global ACLs to disable default read access.
access to dn.children="ou=Users,dc=tripplite,dc=com"
    by: dn="cn=Manager,dc=tripplite,dc=com" write
    by self read
    by anonymous auth
    by * none
```

```
pidfile          /run/slapd.pid
argfile          /run/slapd.args
```

```
#####
# BDB database definitions
#####
```

```
database bdb
suffix "dc=tripplite,dc=com"
rootdn "cn=Manager,dc=tripplite,dc=com"
rootpw secret
directory ./data
```

3. Restart the LDAP server.
4. Write the LDIF file and create the database entries in `init.ldif` with the **ldapadd** command. Example:  
`ldapadd -f init.ldif -x -D "cn=Manager,dc=tripplite,dc=com" -w secret`



# 13. Security

## 13.1 Login Failures

The screenshot shows a configuration panel titled "Login Failures". It contains the following elements:

- An "Enable" checkbox, which is currently unchecked.
- An "Allowed:" label followed by a text input field containing the number "5".
- A "Timeout:" label followed by a text input field containing the number "3" and a "min" label to its right.
- A "Lock Client PC" checkbox, which is unchecked.
- A "Lock Account" checkbox, which is checked.

The Login Failures section sets the parameters for when an account fails to login successfully. To enable settings, check the *Enable* box. Settings are described in the table below.

**Note:** When the Login Failures settings are disabled, there is no restriction on the number of login failures. It is strongly recommended that these features are enabled and both the Lock Client PC and Lock Account settings are also enabled.

Setting	Description
Allowed	Determines the number of failed login attempts an account is allowed before being prohibited from accessing the KVM switch.
Timeout	Determines the amount of time a user is prohibited from accessing the KVM switch after exceeding the maximum number of failed login attempts.
Lock Client PC	When this box is checked, the computer used to unsuccessfully access the KVM will be locked out after exceeding the maximum number of failed login attempts. <b>Note:</b> This feature blocks the computer by using its IP address. If the computer IP address is changed, it will be able to bypass this setting and access the KVM.
Lock Account	When this box is checked, the account used to unsuccessfully access the KVM will be locked out after exceeding the maximum number of failed login attempts.

## 13.2 Filtering

The screenshot shows a configuration panel titled "Filter". It is divided into two main sections:

- IP Filter Section:** Includes an "Enable IP Filter" checkbox (unchecked), radio buttons for "Include" (selected) and "Exclude", a large empty list box, and buttons for "Add", "Modify", and "Delete". Below the list box is a "Login String:" label and an empty text input field.
- MAC Filter Section:** Includes an "Enable MAC Filter" checkbox (unchecked), radio buttons for "Include" and "Exclude" (selected), a large empty list box, and buttons for "Add", "Modify", and "Delete".

To enable IP and/or MAC filtering, check the *IP Filter Enable* and/or *MAC Filter Enable* box. A maximum of 100 filters are allowed for each.

- If the *Include* button is checked, addresses within the filter range are allowed access to the B030-008-17-IP; all other addresses are denied access.
- If the *Exclude* button is checked, addresses within the filter range are denied access to the B030-008-17-IP; all other addresses are allowed access.

## 13. Security

### 13.2.1 IP Filtering

#### To add an IP filter:

1. Check the *IP Filter Enable* box.
2. Click *Add*. A dialog box will appear:

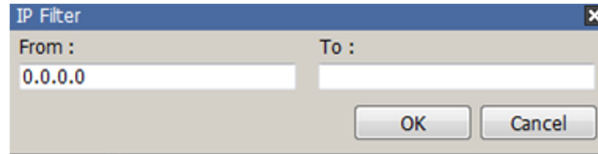

3. To filter a single IP address, enter the same IP address into the *From* and *To* fields.
4. To filter a range of IP addresses, enter the starting IP address in the *From* field and the ending IP address in the *To* field.
5. After entering in the addresses, click *OK*.
6. Repeat these steps for any additional IP addresses you want to filter.

#### To delete an IP filter:

Select the desired IP filter from the list and click *Remove*.

#### To modify an IP filter:

1. Select the desired IP filter from the list and click *Edit*. An *Edit* dialog box similar to the *Add* dialog box will appear.
2. Delete the old *start IP* address and replace it with the new one.
3. Delete the old *end IP* address and replace it with the new one. Click *OK*.

**Note:** To block a computer from accessing the KVM Switch, you do not need to filter both its IP address and its MAC address. Any computer blocked by an IP filter will be denied access to the KVM switch, even if the computer is allowed to access the KVM switch under the MAC filters.

## 13.3 Login String

The Login String allows the KVMs IP address to be more secure by adding extra text to the end of it. When text is entered into the Login String field, users will need to include a forward slash (/) and the Login String at the end of the URL to access the KVM switch. For example, if a Login String of *abcdefg* is entered, the user must enter a URL such as *192.168.0.126/abcdefg*.

The following characters are allowed in the login string:

0 through 9; a through z; A through Z; ~ ! @ \$ & \* ( ) \_ - = + [ ] , . |

The following characters are not allowed:

% ^ " : / ? # \ ' { } ; < > [Space]

Compound characters (É Ç ñ ... etc.)

**Note:** If a Login String is not entered, anyone can access the KVM switch using the IP Address alone, making the installation less secure.

## 13. Security

### 13.4 MAC Filtering

#### To add a MAC filter:

1. Click *Add*. A dialog box appears:

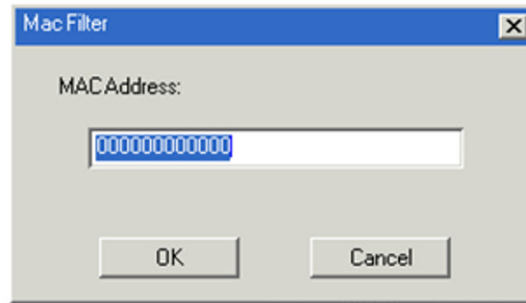

2. Type in the desired MAC address and click *OK*.
3. Repeat these steps for any additional MAC addresses to filter.

#### To delete a MAC filter:

Select the desired MAC filter from the list and click *Remove*.

#### To modify a MAC filter:

1. Select the desired MAC filter from the list and click *Edit*. An Edit dialog box will appear.
2. Delete the old address and replace it with the new one. Click *OK*.

**Note:** To block a computer from accessing the KVM Switch, you do not need to filter both its IP address and its MAC address. Any computer blocked by a MAC filter will be denied access to the KVM switch, even if the computer is allowed to access the KVM switch under the IP filters that are set up.

### 13.5 Account Policy

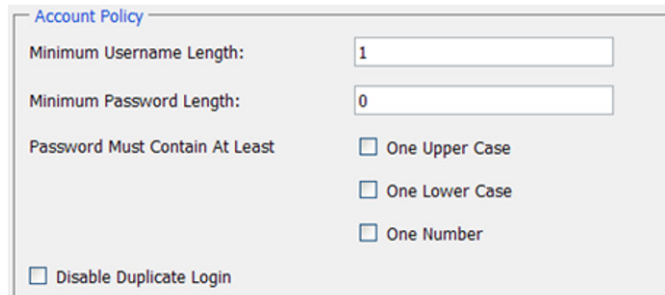
A screenshot of the 'Account Policy' settings dialog. The title bar is blue with the text 'Account Policy'. The main area is light gray and contains several settings: 'Minimum Username Length' with a text input field containing '1'; 'Minimum Password Length' with a text input field containing '0'; 'Password Must Contain At Least' with three checkboxes: 'One Upper Case', 'One Lower Case', and 'One Number', all of which are unchecked; and 'Disable Duplicate Login' with an unchecked checkbox.

The Account Policy subsection allows rules for usernames and passwords to be regulated. The settings are described in the table below.

Item	Description
Minimum Username Length	Sets the minimum number of characters required for each username. Values from 1 to 16 can be entered.
Minimum Password Length	Sets the minimum number of characters required for each password. Values from 0 to 16 can be entered.
Password Must Contain at Least	<ul style="list-style-type: none"><li>• One Upper Case – Checking this box will require each password contain one upper case letter.</li><li>• One Lower Case – Checking this box will require each password contain one lower case letter.</li><li>• One Number – Checking this box will require each password contain one number.</li></ul> <p><b>Note:</b> Current usernames and passwords are not affected when these settings are changed. Only usernames and passwords that are created after these settings have been changed are bound by these regulations.</p>
Disable Duplicate Login	Checking this box will prevent users from logging in with the same username and password to open more than one session at the same time.

# 13. Security

## 13.6 Mode

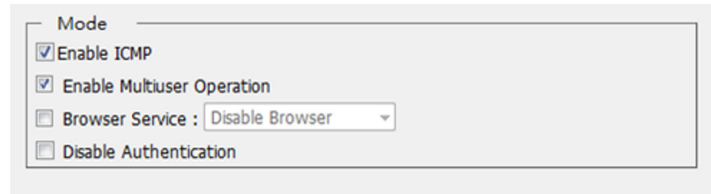

The screenshot shows a configuration window titled "Mode" with the following settings:

- Enable ICMP
- Enable Multiuser Operation
- Browser Service : Disable Browser (dropdown menu)
- Disable Authentication

The Mode operation settings are described in the table below.

Item	Description
Enable ICMP	When this box is checked, the KVM switch can be pinged. If it is not checked, the KVM cannot be pinged.
Enable Multiuser Operation	When this box is checked, multiple accounts (up to 32) can remotely log on to the KVM at the same time. If not selected, only one user can log on at a time. The default is enabled.
Browser Service	When this box is checked, browser access to the KVM switch can be limited by selecting one of the three options in the drop-down menu. <ul style="list-style-type: none"><li>• <i>Disable Browser</i> – Browser access is completely disabled.</li><li>• <i>Disable HTTP</i> – Browser access is permitted, but only when using an HTTPS URL.</li><li>• <i>Disable HTTPS</i> – Browser access is permitted, but only when using an HTTP URL.</li></ul>
Disable Authentication	When this box is checked, no authentication procedures are used to check accounts logging into the KVM. All users will be logged onto the KVM switch with full access, regardless of what account type they are. <b>Note:</b> <i>Enabling this setting creates a very unsecure situation, and is not recommended.</i>

## 13.7 Private Certificate

When logging into the KVM switch over a secure (SSL) connection, a certificate is required to ensure you are logging into a secure site. If a certificate is not recognized as secure, you will be prompted each time you log in to verify you want to continue to the website. This section allows you to import an Encryption Key and Certificate. To import an Encryption Key and Certificate, follow the steps below.

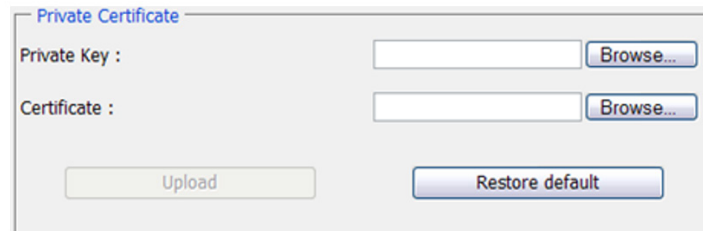

The screenshot shows a configuration window titled "Private Certificate" with the following fields and buttons:

- Private Key :  Browse...
- Certificate :  Browse...
- Upload (button)
- Restore default (button)

1. Click the *Browse* button to the right of Private Key, browse to where your private encryption key file is located, then select it.
2. Click the *Browse* button to the right of Certificate, browse to where your certificate file is located, and then select it.
3. Click the *Upload* button to complete the procedure.

**Note:** *Both the Private Key and Certificate must be imported at the same time. Clicking the Restore Default button returns the KVM to the default certificate preinstalled on it.*

## 14. Date/Time

The Date/Time page sets the date and time parameters for the KVM switch.

The screenshot shows the Date/Time configuration page with the following details:

- Time Zone:** [GMT+08:00] Taipei
- Daylight Savings Time
- Date:** April, 2010. Calendar grid showing the 9th of April selected.
- Time:** 11 : 47 : 43. Set button.
- Network Time:**
  - Enable auto adjustment
  - Preferred time server: AU | ntp1.cs.mu.OZ.AU
  - Preferred custom server IP
  - Alternate time server: AU | ntp1.cs.mu.OZ.AU
  - Alternate custom server IP
  - Adjust time every: 1 days. Adjust Time Now button.
- Buttons: Save, Close

### 14.1 Time Zone

- From the drop-down menu at the top of the section, select the Time Zone and City that most closely resembles where the KVM switch is located.
- If your area uses Daylight Savings Time, check the *Daylight Savings Time* box.

#### To manually set the date and time:

1. In the Date section, select the current month from the drop-down menu.
2. If needed, click the < or > buttons in the Date section to move backward or forward to the correct year.
3. In the calendar in the Date section, click on the current day.
4. In the Time section, enter the current time using the 24 hour HH:MM:SS format.
5. Click the Set button in the Time section to apply changes.

### 14.2 Network Time

To have the time automatically synchronized to a network time server, do the following:

1. Check the *Enable Auto Adjustment* box.
2. Select a time server from the Preferred Time Server drop-down list or check the *Preferred Custom Server IP* box and enter the IP of your preferred time server.
3. If desired, repeat step two to enter an Alternate Time Server.
4. Enter the desired number of days between synchronization in the *Adjust Time Every \_\_\_ Days* field.
5. Click the *Adjust Time Now* button to synchronize immediately.

# 15. Log

The B030-008-17-IP logs all the events that occur and records them to a log file.

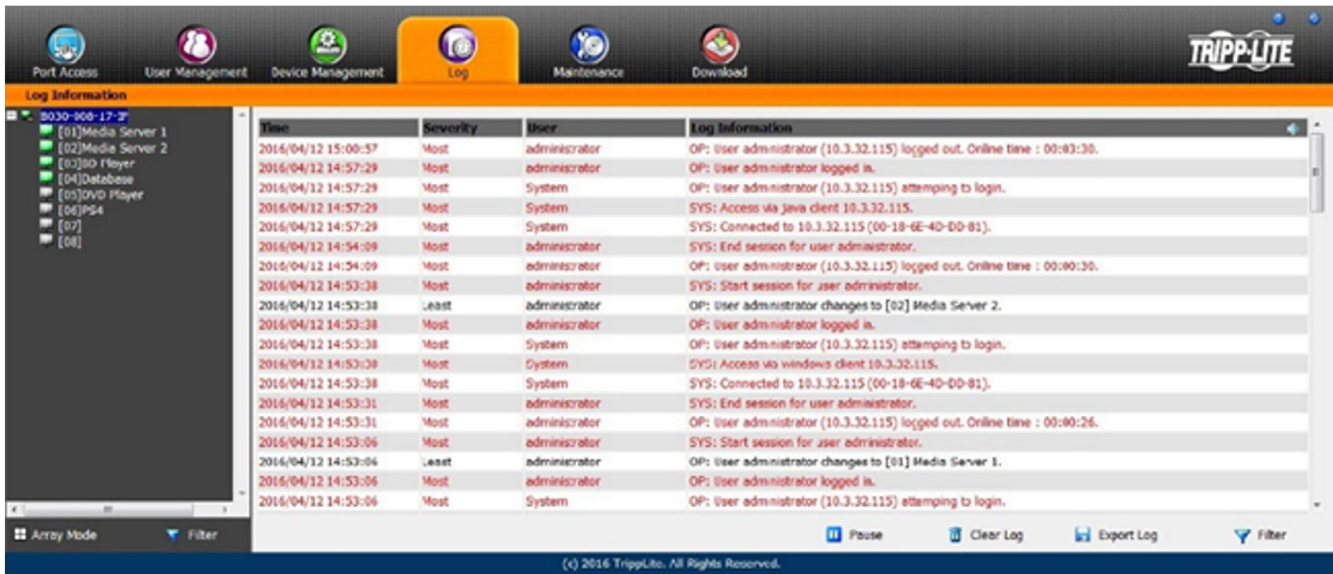

The Log Information page can store up to 512 events, at which time the oldest files are deleted and replaced with newer files. The records it displays show the Time, Severity, User and Log Information associated with the event. Four icons are located at the bottom of the screen:

- **Pause** – Clicking the *Pause* button stops new events from being displayed in the Log Information page. When clicked, the icon changes to *Resume*. Click *Resume* to allow events to be displayed again.
- **Clear Log** – Clicking the *Clear Log* button will clear the records displayed in the Log Information page.
- **Export Log** – Clicking the *Export Log* button exports and saves the log file to your computer.
- **Filter** – Clicking the *Filter* button opens the Filter settings (shown below) which displays records that only match the filter settings entered

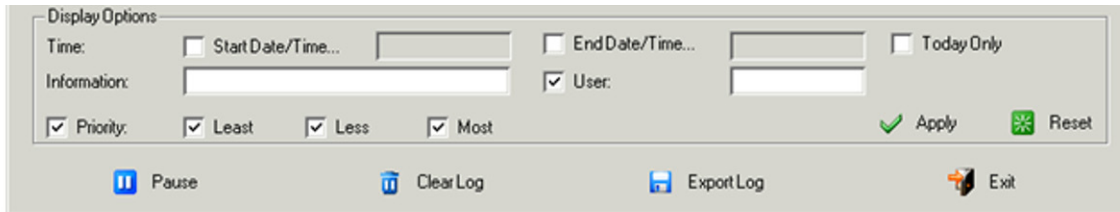

Item	Description
Time	The Time filter settings displays only those records that occurred at a specific time. Options include: <ul style="list-style-type: none"> <li>• <b>Today Only</b> – Check the <i>Today Only</i> box and click the <i>Apply</i> button to display only those events that occurred on today's date.</li> <li>• <b>Start Date/Time</b> – Check the <i>Start Date/Time</i> box and click the field to the right of it to open a calendar to select a desired date and time. Click the <i>Apply</i> button to display all events that occurred between the date/time entered into the Start Date/Time field and the present date/time.</li> <li>• <b>End Date/Time</b> – This setting works in conjunction with the Start Date/Time field. Check the <i>Start Date/Time</i> box and click the field to the right of it to open a calendar that allows you to select a desired date and time. Check the <i>End Date/Time</i> box and click in the field to the right of it to open a calendar that allows you to select a desired date and time. Click the <i>Apply</i> button to display all of the events that occurred between the date/time entered into the Start Date/Time field and the date/time entered into the End Date/Time field.</li> </ul>
Information	The Information field allows you to type in a key word or string, and display only those records that contain the search term. Simply type in a search term and click the <i>Apply</i> button.
User	The User field allows you to type in a user name and display only those records that contain the text that you entered in the User field. To filter by User, check the User box, type in a search term and click the <i>Apply</i> button.
Priority	The Priority fields filter the Priority of the event being recorded; Least, Less or Most. To filter by Priority, check the Priority box, then check the Priority level box(es) to filter. Click the <i>Apply</i> button.
Reset	Click the <i>Reset</i> button at any time to clear filter settings that were entered and display all events.
Exit	Click the <i>Exit</i> button to close the Filter settings.

## 15. Log

### Notification Settings

Notification Settings select which events are sent out to SNMP, SMTP and SysLog servers. Simply check the boxes in the rows of the events that you want notifications for and check the column(s) of the methods you want them to be sent to. When checked, the corresponding event notification will be sent using the corresponding method.

**Note:** Notifications default with an “X” to indicate they are disabled. Click on a notification box to enable it. You can check multiple boxes at the same time using the [Shift] or [Ctrl] keys. To highlight a group of consecutive ports, start by highlighting the first port, hold down the [Shift] key, then highlight the last port you wish to highlight. All ports from the first to the last will be highlighted. Click on any of the permission checkboxes to change that permission for all of the highlighted ports. To highlight multiple non-consecutive ports, start by highlighting the first port, hold down the [Ctrl] key, then highlight each additional port while continuing to hold down the [Ctrl] key. When all of the desired ports are highlighted, click on any box to change that permission for all of the highlighted ports.

## 16. Maintenance

The Maintenance section is used to upgrade the B030-008-17-IP firmware, backup and restore configuration / account information, ping network devices, and restore default values. When the Maintenance page is accessed, it will open with the Upgrade Main Firmware subsection displayed.

**Note:** Super Administrators are the only users with guaranteed access to the Maintenance section of the KVM. Administrators and Users can only access this function if given permission.

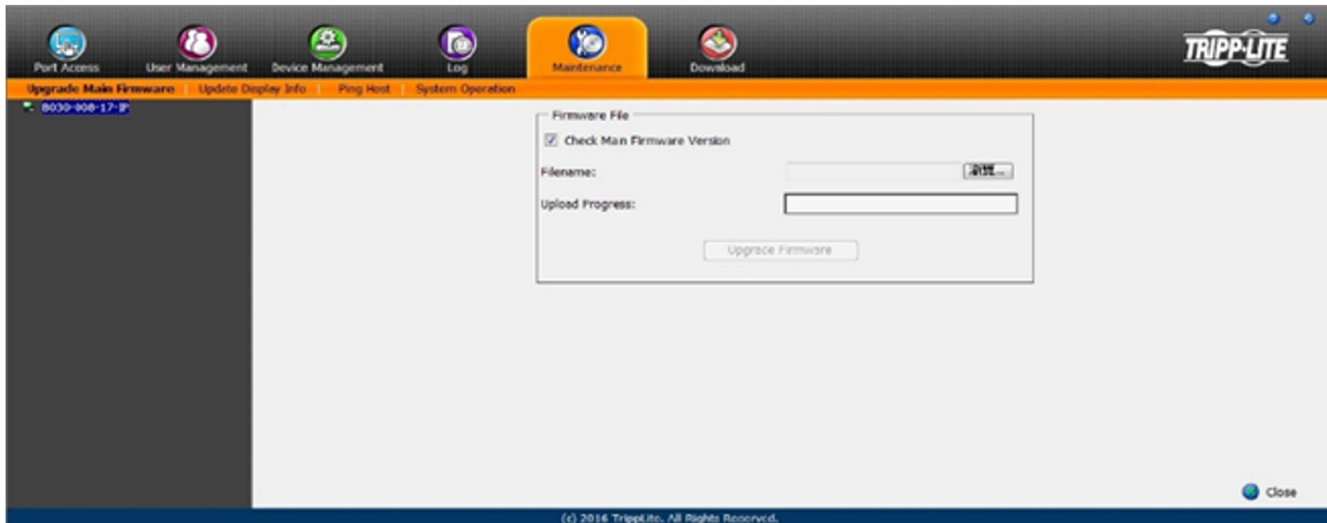

### 16.1 Upgrade Main Firmware

The Upgrade Main Firmware subsection is used to upgrade the firmware of the KVM switch. As firmware upgrades become available, they can be downloaded from [triplite.com/support](http://triplite.com/support). To upgrade the KVM firmware:

1. Go to [triplite.com/support](http://triplite.com/support) to download the most current firmware and save it to a computer that is not connected to the KVM switch.
2. Log on to the Web Interface and navigate to the Maintenance section, which will open with the Upgrade Main Firmware subsection displayed.
3. By default, the Check Main Firmware Version box is checked, which causes the KVM to check if the current firmware is newer than the firmware file being used to upgrade the KVM. If the current version is newer, you will not be allowed to continue with the upgrade. If performing a firmware upgrade without checking to see if the current firmware version is newer than the upgrade file, simply uncheck this box.
4. Click the *Browse* button, and navigate to and select the firmware upgrade file downloaded from the Tripp Lite website. When selected, the *Upgrade Firmware* button becomes active.
5. Click the *Upgrade Firmware* button to begin the firmware upgrade. As the upgrade proceeds, progress is shown in the Upload Progress bar.
6. When the upload is complete, a popup appears stating the system will reboot in a few seconds. The KVM switch will reboot (this may take a few minutes) and the upgrade will be complete. In the event of a firmware upgrade failure, see the **Main Firmware Upgrade Recovery** section below.

#### 16.1.1 Main Firmware Upgrade Recovery

Should the KVM firmware upgrade procedure fail and the switch becomes unusable, follow the steps below to restore the KVM:

1. Power off the KVM.
2. Press and hold the Reset switch on the front of the device.
3. Power on the KVM while holding down the Reset switch.
4. The KVM will be restored to the originally installed firmware version. You will now be able to access the KVM switch and try upgrading the firmware again.



## 16. Maintenance

### 16.2 Update Display Info

The Update Display Info button queries the local monitor's EDID information and updates it. The EDID information communicates with the server's video card about the display hardware it is connected to (e.g. the monitor connected to the KVM console).

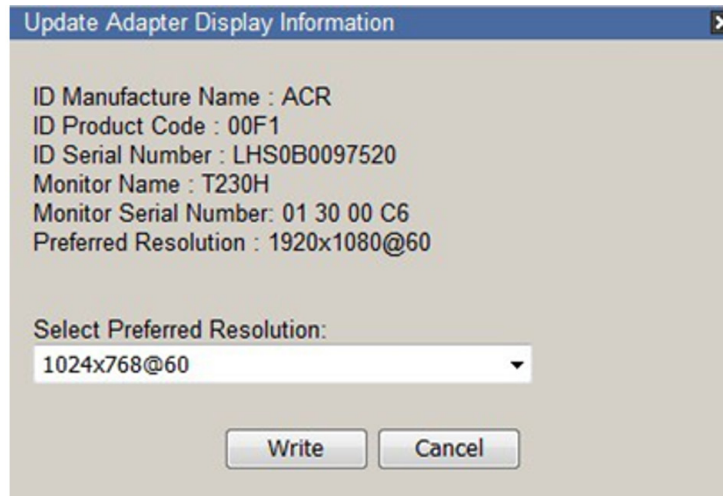

Update Adapter Display Information

ID Manufacture Name : ACR  
ID Product Code : 00F1  
ID Serial Number : LHS0B0097520  
Monitor Name : T230H  
Monitor Serial Number: 01 30 00 C6  
Preferred Resolution : 1920x1080@60

Select Preferred Resolution:  
1024x768@60

Write Cancel

The monitor's Preferred Resolution (Optional) is included in the Display Information window. To apply the preferred resolution, select an option from the Select Preferred Resolution drop down menu, then click *Write*.

### 16.3 Backup / Restore

The Backup/Restore function backs up and restores the KVM switch configuration and user profile information.

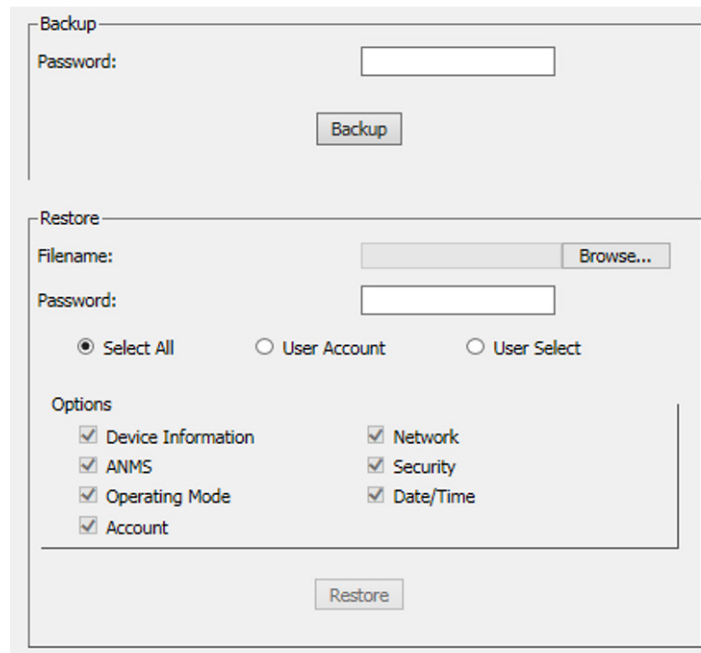

Backup

Password:

Backup

Restore

Filename:  Browse...

Password:

Select All  User Account  User Select

Options

Device Information  Network  
 ANMS  Security  
 Operating Mode  Date/Time  
 Account

Restore

#### Backup

To create a backup of the KVM switch:

1. Enter a password in the *Password* field.

**Note:** Setting a password is optional. If you do not wish to use a password, you can skip this step.

2. Click the *Backup* button.
3. A pop-up will appear ask to save the backup file. Save the file to a desired location on your computer.

## 16. Maintenance

### Restore

To restore the KVM switch using a backup file:

1. Click on the *Browse* button to the right of the filename field and select the backup file.
2. If you set up a password when creating the backup file, enter it in the *Password* field.
3. Select as many options you wish to restore, then click the *Restore* button. Once complete, a message will appear stating the procedure succeeded.

### 16.4 Ping

The Ping menu item checks the network status of devices on the B030-008-17-IP installation:



#### To ping a device:

1. Enter the device's IP Address or Host Name into the text entry box.
2. Click *Ping*. The ping results display in the Result panel.

## 16. Maintenance

### 16.5 System Operation

The System Operation subsection clears port name and resets the KVM configuration settings to their default values.

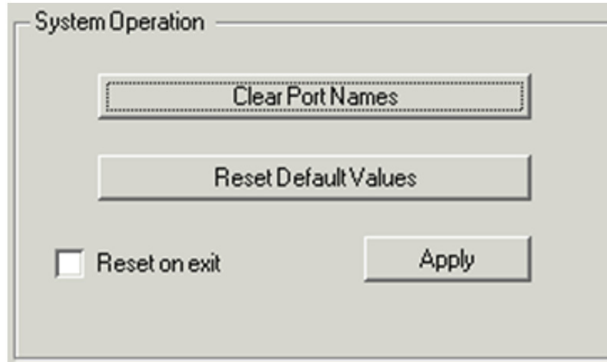

Item	Description
Clear Port Names	Click this button to clear all port names on the installation and restore to their default values. Upon clicking this button, a prompt will appear to confirm that you wish to clear all port names. Click Yes.
Reset Default Values	Click this button to undo all Customization page changes that have been made, as well as the Network Transfer Rate setting, and restore them to the factory default settings. Upon clicking this button, a prompt will appear to confirm that you wish to proceed. Click Yes.
Reset on Exit	Check this box and click the Apply button for the KVM switch to reset and implement new settings upon logging out (following the reset, allow approximately 30 to 60 seconds before logging back into the KVM). If the KVM's IP address is changed, the <i>Reset on Exit</i> box is automatically checked. To prevent the KVM from resetting and saving the new IP address, uncheck this box. <b>Note:</b> Un-selecting this box will only cause the new network settings to be ignored for one logout. When re-logging in, the changes made still appear in the Network settings fields and the <i>Reset on Exit</i> box is once again checked. To avoid unwanted changes to settings, always ensure that the Network Settings page contains the correct information entered in.

### 16.6 Download

The Download icon is used to download the log server and non-browser AP versions of Windows and Java Clients. Selecting this tab will open a drop-down list of the programs available for download.

**Note:** If you have not been given access to one of these applications, you will not be able to download it. Click on the Download icon and select the program. Save the file to a convenient location on your hard disk run the program from there.

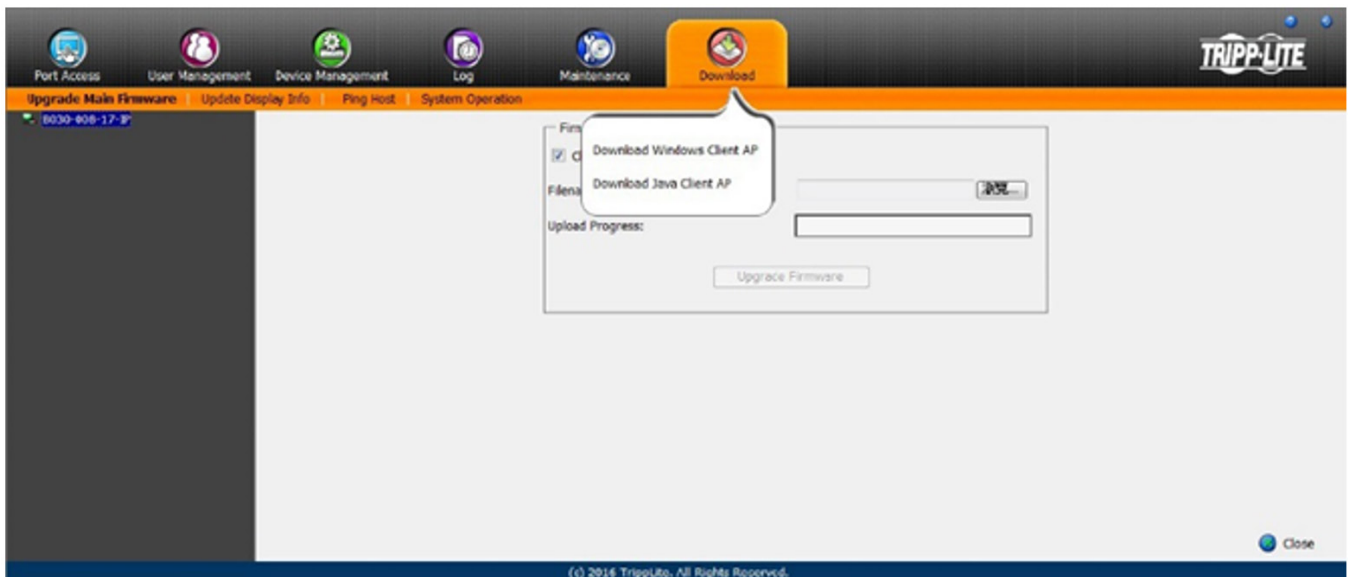

## 17. Log Server

The Windows-based Log Server is an administrative utility that records all the events on selected B030-Series KVM Switch units and writes them to a searchable database.

### 17.1 Installation

1. From the computer designated as the Log Server, open the browser and log in to the KVM Switch.
2. Download the Log Server by clicking on the *Download* Icon at the top of the page and selecting it from the drop-down list.
3. Navigate to where the Log Server file is saved and double-click to open. Ignore any security warning dialog boxes that appear and click *Run* or *Open*. The Log Server installation screen will appear.
4. Click *Next*. Then follow the onscreen instructions to complete the installation and have the Log Server program icon showing on the desktop.
5. Before opening the Log Server, go to the Device Management section of the KVM switch web interface and open the ANMS tab. In the corresponding fields, enter the MAC Address and Port Number for the computer/server that the Log Server is installed on (refer to **12.1 Advanced Network Management Settings** for more information).

### 17.2 Opening the Log Server

To open the Log Server, either double-click the program icon or enter the full path to the program on the command line. The first time the program is run, a screen as shown below will appear:

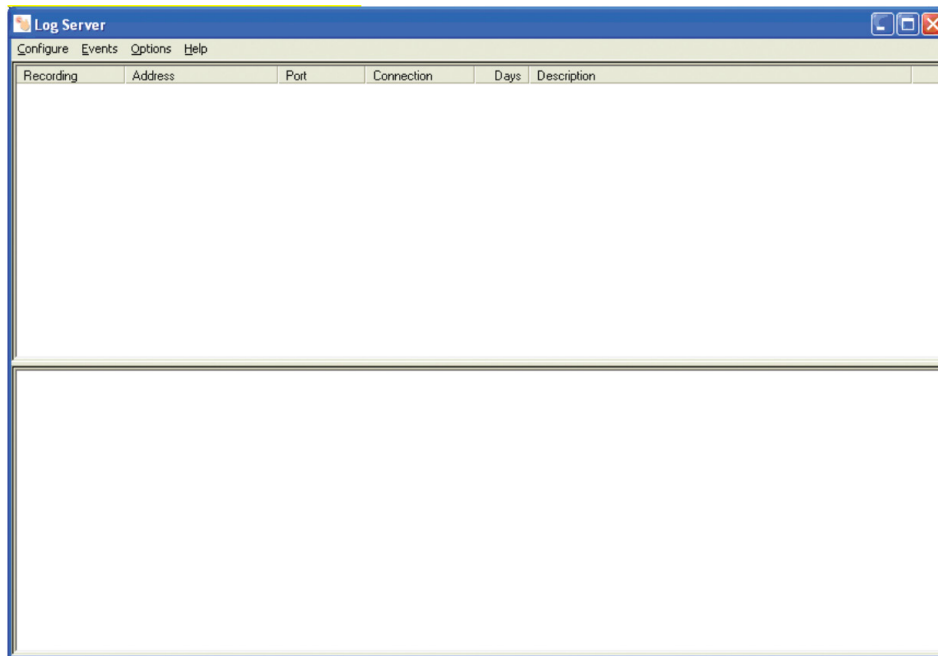

**Note:** The Log Server requires the Microsoft Jet OLEDB 4.0 driver in order to access the database.

The screen is divided into three components:

- A Menu Bar at the top
- A panel that will contain a list of all B030-Series KVM Switch units in the middle
- A panel that will contain an Events List at the bottom

### 17.3 Menu Bar

The Menu bar consists of four drop-down menus:

- Configure
- Events
- Options
- Help

**Note:** If the Menu Bar appears to be disabled, select one of the KVM units from the list window to enable.

# 17. Log Server

## 17.3.1 Configure

The Configure menu consists of three functions: Add, Edit and Delete.

### Add

Select the Add function when adding a new KVM switch to the list of units the Log Server records events for.

**Note:** First add a KVM via the Add function before the Log Server can start recording its events.

When opening the Add function, the following dialog box will appear (function descriptions can be found in the table below):

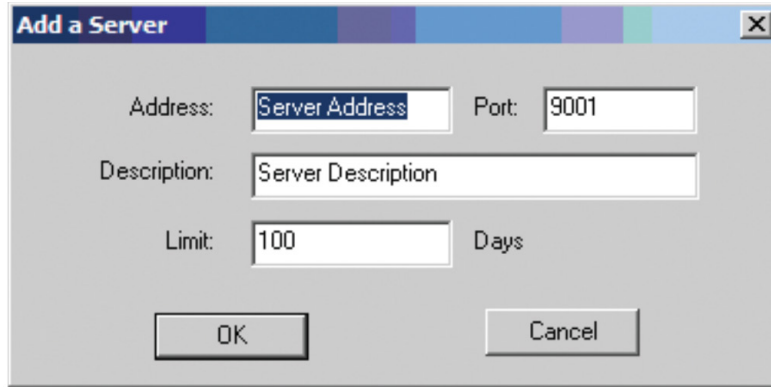

Field	Description
Address	This can either be the KVM's IP address or its DNS name (if the network administrator has assigned it a DNS name). This value must be entered into the ANMS tab of the OSD Device Management Notebook to communicate with the Log Server (refer to <b>12.1 Advanced Network Management Settings</b> for more information).
Port	Enter the port number specified in the ANMS tab of the OSD Device Management Notebook. If the port number differs between the KVM's web interface and the Log Server, the two will not be able to communicate with each other.
Description	Additional information can be added in this field to help differentiate the KVM from the rest of the devices the Log Server is recording information for.
Limit	Specifies the number of days an event is kept in the Log Server's database before it can be deleted. To remove all events that passed the expiration date set in this field, use the Maintenance function in the Events menu.

## 17.3.2 Edit

Select the Edit function to modify the information pertaining to an existing KVM. To edit an existing KVM, select it from the list and open the Edit function from the Configure drop-down menu. A dialog box will appear showing the exact information that was entered for the KVM when it was added using the Add function. Edit this information and click OK.

## 17.3.3 Delete

To delete a KVM, simply select it from the list and open the Delete function. A dialog box will appear displaying the KVM's information and requesting to click OK to delete it. To remove it from the Log Server, click OK.

# 17. Log Server

## 17.4 Events

The Events Menu consists of two items: Search and Maintenance.

### 17.4.1 Search

Search allows users to search for events containing specific words or strings. When accessing this function, a window will open (item descriptions can be found in the table below):

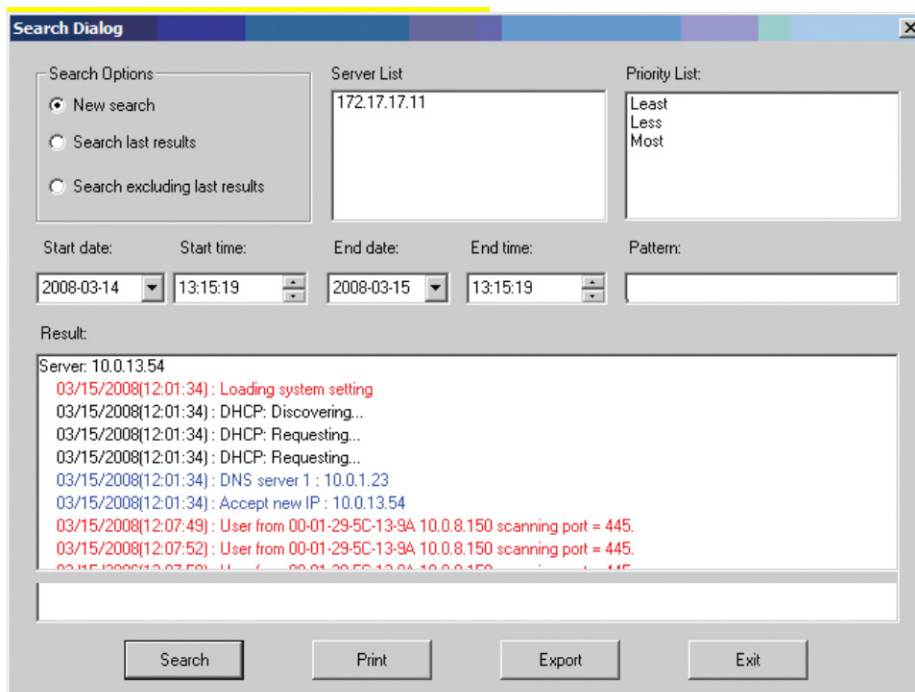

Item	Description
Search Options	<b>New search:</b> When selected, the search is performed on all the events in the database for the selected KVM. <b>Search last results:</b> This is a secondary search performed on the events that resulted from the last search. <b>Search excluding last results:</b> This is a secondary search performed on all the events in the database for the selected KVM, excluding the events that resulted from the last search.
Server List	KVM units are listed according to their IP address. Select the unit from this list to perform a search. More than one unit can be selected for the search. If no units are selected, the search is performed on all KVMs.
Priority List	Sets the level for how detailed the search results displayed should be. If no results are selected, all results will display. If all results display, entries highlighted red are of high or most important to installation security; entries highlighted blue are of medium or less important to installation security; and entries highlighted black are of least importance to installation security.
Start Date	Select the date you wish the search to start from. The format follows the MM/DD/YYYY convention (e.g. 11/15/2009).
Start Time	Select the time you wish the search to start from.
End Date	Select the date you wish the search to end at. The format follows the MM/DD/YYYY convention (e.g. 11/15/2009).
End Time	Select the time you want the search to end.
Pattern	Enter text you wish the search to filter the events by.
Results	The events that matched the search terms are listed here.
Search	After entering all of search terms, click this button to start the search.
Print	Prints the search results.
Export	Export Log Server search results as a text file.
Exit	Exits the <i>Search</i> dialog box.

## 17. Log Server

### 17.5 Maintenance

This function allows the administrator to remove all records that have passed their expiration limit (refer to **17.3.1 Configure** for limit details). In order to delete old files from the log server, the maintenance function must be performed.

### 17.6 Options

The Options menu consists of only one function: Network Retry.

#### 17.6.1 Network Retry

Network Retry sets the number of seconds the Log Server should wait before attempting to connect if the previous connection attempt failed. When clicking this item, a dialog box will appear:

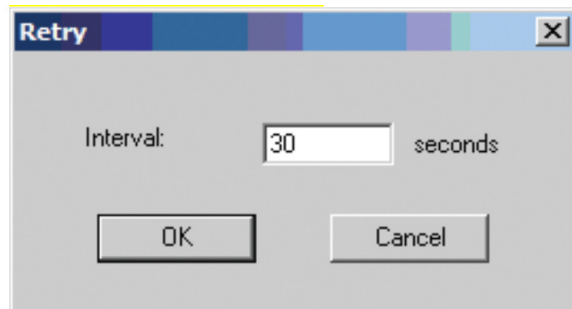

Enter the desired number of seconds and click *OK* to finish.

### 17.7 Help

The Help menu consists of two options; Contents and About Log Server.

#### 17.7.1 Contents

Selecting the Contents function opens an online Windows Help file. The Help file contains instructions on how to set up, operate and troubleshoot the Log Server.

#### 17.7.2 About Log Server

Selecting the About Log Server option opens a dialog box displaying the Log Server's version number.

# 17. Log Server

## 17.8 Log Server Main Screen

The Log Server Main Screen is divided into two main panels: an upper (List) panel displaying all devices added to the Log Server and a lower (Event) panel displaying log events for the currently selected KVM. To select a KVM unit in the list, simply click on it.

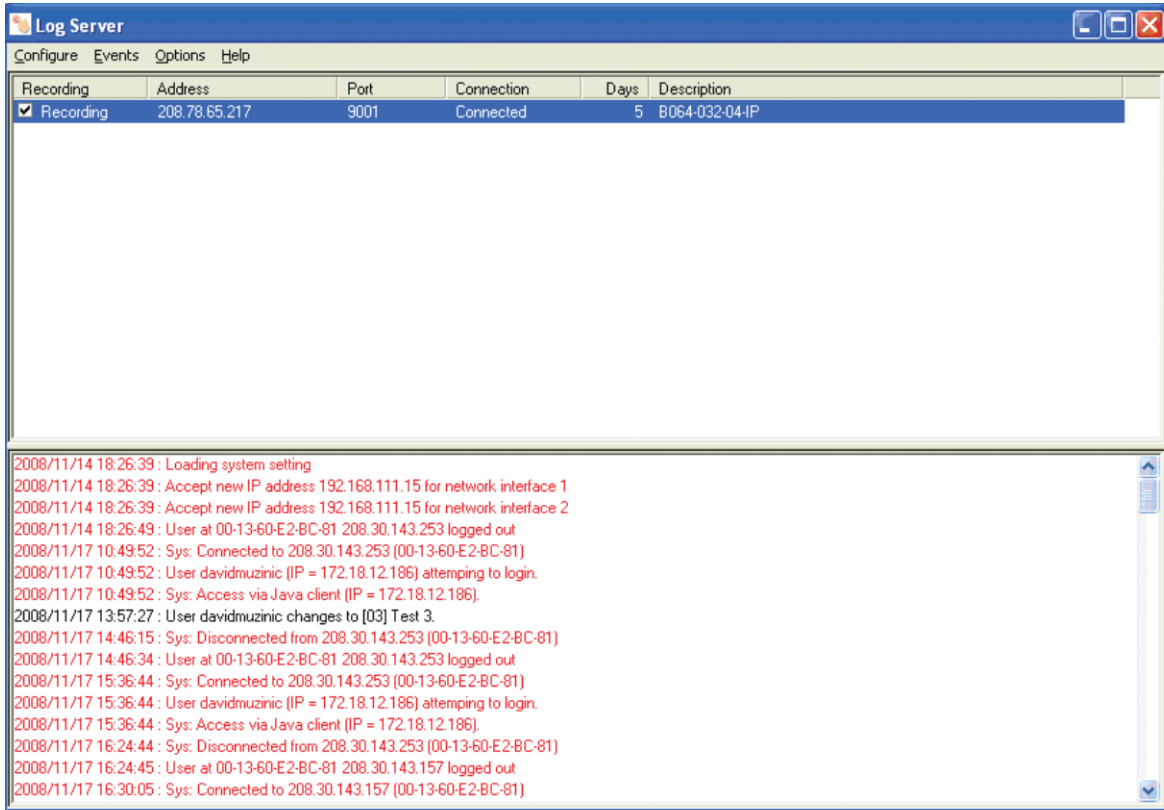

### List Panel Fields

Field	Description
Recording	Determines whether the Log Server records log events for the corresponding KVM. If the <i>Recording</i> box is checked, the field displays Recording, and log events are recorded. If the <i>Recording</i> box is not checked, the field displays Paused, and log events are not recorded. <b>Note:</b> Even if a KVM is not currently selected, if its Recording box is checked, the Log Server will continue to record its log events.
Address	This is the IP Address or DNS name given to the KVM when it was added to the Log Server.
Port	This is the port number assigned to the KVM when it was added to the Log Server.
Connection	If the Log Server is properly connected to the KVM, this field displays <i>Connected</i> . If it is not connected, this field displays <i>Waiting</i> . In effect, the Log Server is not communicating with KVM and will not record its events. This occurs when the Log Server's MAC address and/or port number have not been set properly. The MAC Address and Port for the Log Server computer must be entered into the ANMS tab of the OSD Device Management Section. In addition, the KVM's IP Address and Port must be entered when adding it to the Log Server. If the KVM's and Log Server's port numbers do not match, they will not be able to communicate.
Days	Displays the number of days the KVM's log events are to be kept in the Log Server's database before they are eligible for deletion.
Description	Displays the descriptive information given for the KVM when it was added to the Log Server.

### Event Panel

The lower panel displays event information for the currently selected KVM.



## 18. Remote Session Operation

After successfully logging in (see **10. Logging in to the KVM over IP** for more information), the Web Interface Main Page will appear with the Port Access tab selected:

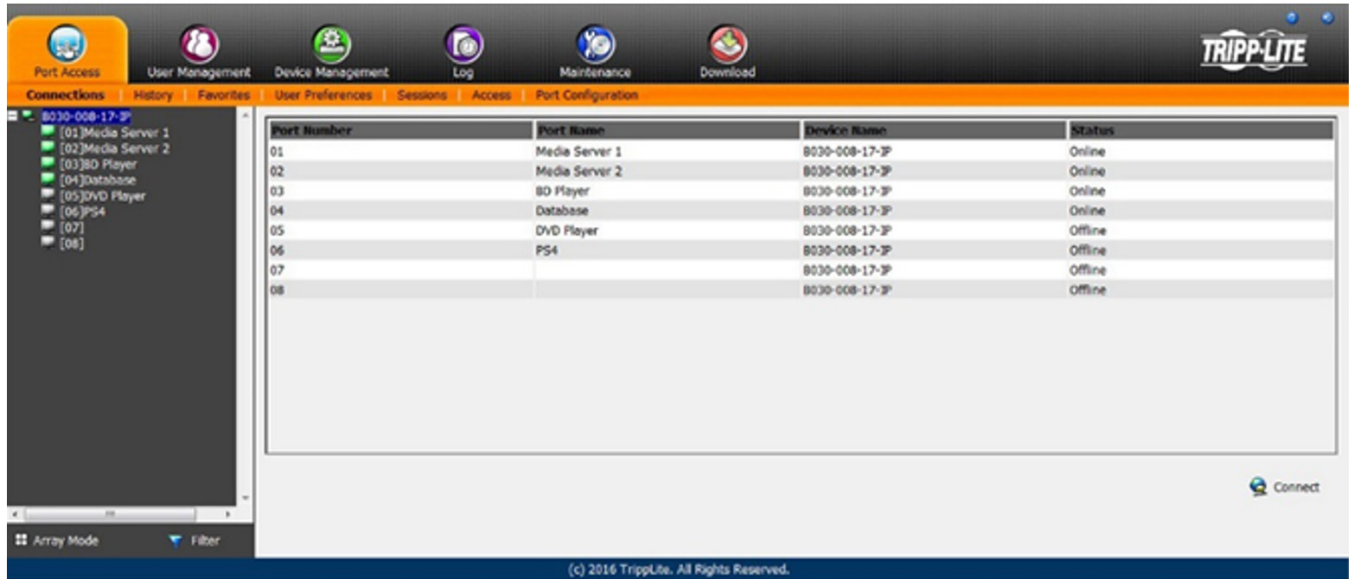

All ports that a user is permitted to access are listed on the left of the Port Selection panel. Ports that users do not have access to will not be displayed. Double-click a port icon to access the attached device. Once a user switches to a port, its screen will display on their monitor. Whether a user has Full Access or View Only access to the port will determine if the user is able to operate the remote computer using their keyboard and mouse.

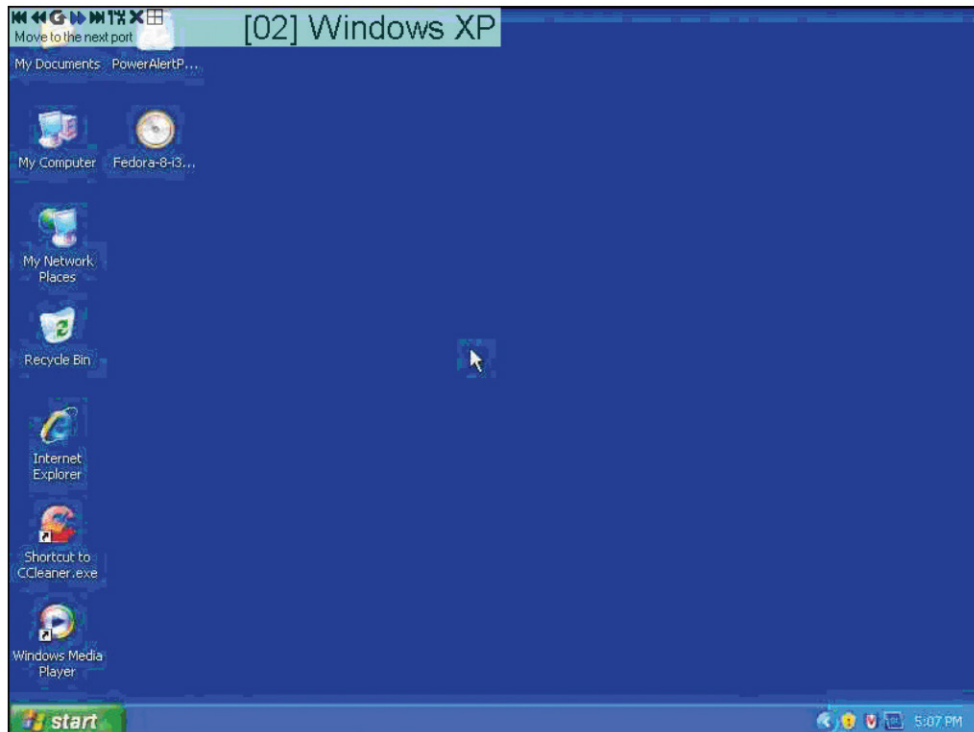

# 18. Remote Session Operation

## 18.1 Control Panel

The Control Panel is a way for the user to optimize and control the remote session. Regardless of whether the user initiated a remote session via the Windows or Java browser and non-browser clients, the control panel and its functionality remain the same. To display the Control Panel, hover the mouse pointer over the top-center of the remote screen.

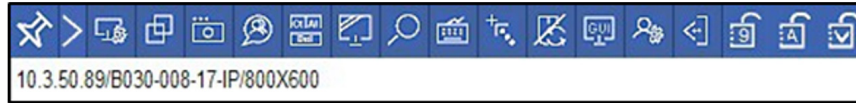

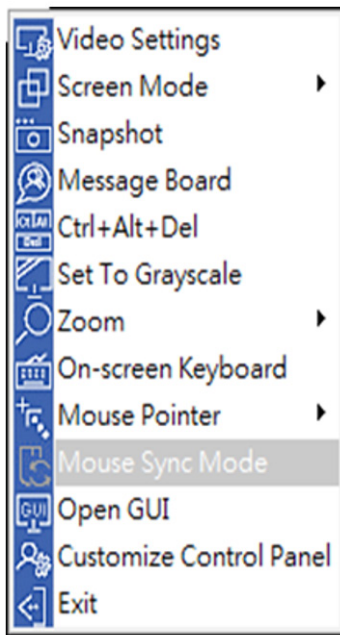

The Control Panel consists of an icon bar situated above two text bars. When the mouse pointer is hovered over an icon, the icon description is displayed in the text bar. When the mouse pointer is not over an icon, the text bars display the video resolution of the selected computer and the IP address of the KVM switch. The control panel can be dragged to any location on the remote screen by hovering over the text bar and then clicking and moving it to the desired desktop location.

Right clicking in the text bars initiates a menu-style version of the toolbar. In addition, it allows the user to select options for the Zoom, Mouse Pointer, and Mouse Sync Mode.



The Control Panel icons are explained in greater detail below:

-  **Always on Top / Auto Hide** – Click this button to toggle between displaying the control panel all of the time or allowing it to disappear after a few seconds of inactivity.
-  **Video Settings** – The Video Settings screen adjusts the placement and picture quality of the remote screen. The image display quality has a direct effect on the keyboard and mouse response time. Higher quality video results in more information being transferred over the network, which can cause slow keyboard and mouse response time in slower networks. Click this icon to open the Video Settings screen or right-click on to perform an Auto Sync.

# 18. Remote Session Operation

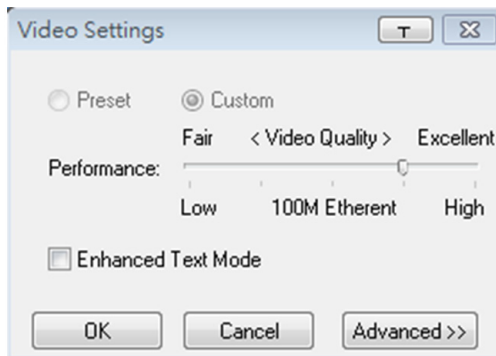

Basic Video Settings

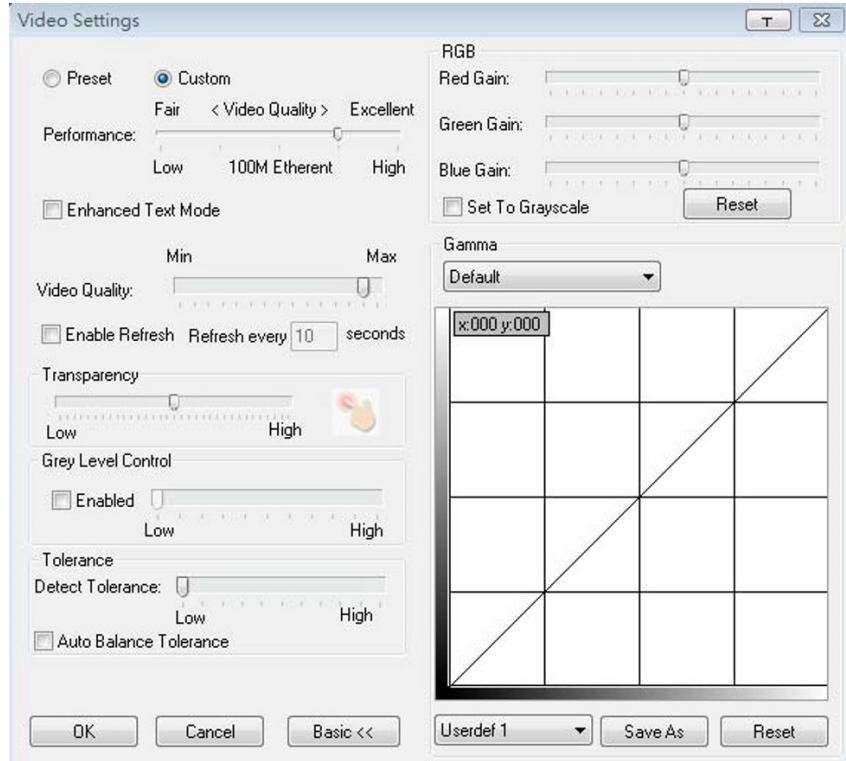

Advanced Video Settings

## Video Adjustment Options

Option	Usage
RGB	Move the RGB (Red, Green, Blue) slider bars to adjust the corresponding color component of the video image. Check the <i>Set to Grayscale</i> box to display the video of the remote computer without color. If the remote keyboard and mouse response time is slow or choppy, the <i>Set to Grayscale</i> option can speed it up.
Gamma	Adjusts the video display's gamma level. This function is discussed in greater detail in the <b>Gamma Adjustment</b> section.
Performance	Use the slide bar to select the type of internet connection the local client computer uses. The switch will use that selection to automatically adjust the Video Quality and Detect Tolerance settings to optimize the video display quality. Because network conditions vary, if none of the pre-set choices appear to work well, use the Video Quality and Detect Tolerance slider bars to adjust the settings to suit your conditions.
Video Quality	Drag the slider bar to adjust the remote computer's overall video quality. On slower networks, lowering the video quality can help improve keyboard and mouse response time.
Enable Refresh	The remote screen can be set to be redrawn every 1 to 99 seconds, which eliminates unwanted artifacts that would otherwise remain on the screen. Click the <i>Enable Refresh</i> box to activate this feature, then enter the desired refresh rate.
Transparency	Adjusts the transparency of the Remote Session Toolbar displayed when the [Scroll Lock] [Scroll Lock] hotkey is initiated in a remote session. Move the slider bar until the transparency is set to the desired level.
Detect Tolerance	This setting governs allowable pixel changes. A high setting limits changes, resulting in lower video quality and less data transfer. A low setting allows more changes, resulting in higher video quality and greater data transfer. On slower networks, a high detect tolerance setting can help improve keyboard and mouse response time.
Preset / Custom	The <i>Preset</i> and <i>Custom</i> buttons set and save custom video settings, and revert to default video settings.

## 18. Remote Session Operation

### Gamma Adjustment

If it is necessary to correct the gamma level for the remote computer, use the Gamma function in the Video Settings screen. Under the Basic configuration, the gamma drop-down list includes ten preset and four user-defined gamma levels to choose from. Simply select the desired setting from the drop-down list. To manually set gamma levels:

1. Click the *Advanced* button to open the gamma adjustment settings.

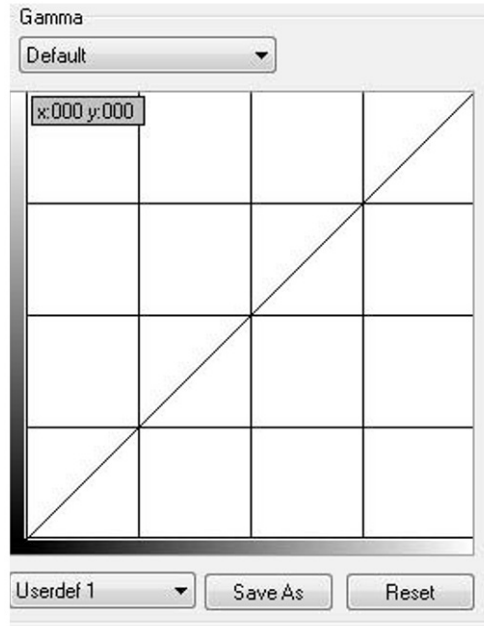

2. Click and drag the diagonal line at as many points as you wish to achieve the desired display output. Click the *Reset* button at any time to abandon changes and return to the default gamma settings. Click the *Cancel* button to abandon changes and close the Video Settings window.
3. To save the new gamma settings, select a user-defined setting from the drop-down list and click the *Save* button. Personalized gamma settings will be saved to the selected user's defined option.

 **Screen Mode** – Toggles Full Screen mode on/off.



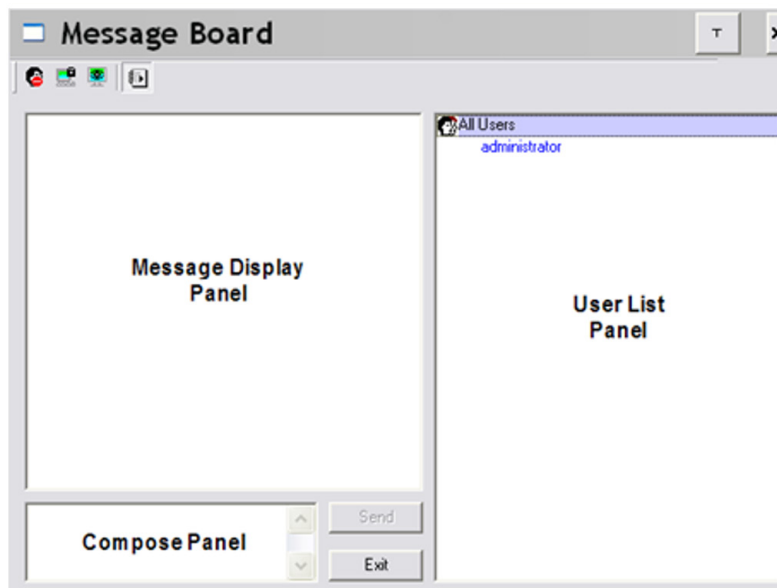

 **Snapshot** – Takes a screenshot of the remote computer and saves it to the local computer. By default, snapshots are saved to the local computer's desktop. The file type, quality and location can be changed via the Customize Control Panel page.

 **Message Board** – The B030-008-17-IP supports multiple user logins, which can cause access conflicts. To alleviate this problem, a message board feature allows users to communicate with one another.



# 18. Remote Session Operation

The buttons on the button bar at the top of the message board are toggles.

Button	Function
	Enable/Disable Chat – When disabled, this icon displays next to the disabled user’s name in the User List panel of all users’ message boards. Messages directed to the disabled user are not displayed on the message board. The button is shadowed when chat is disabled.
	Occupy/Release Keyboard/Video/Mouse – When using the KVM, other users cannot view video and cannot input keyboard or mouse data. A prompt will appear on the locked out users’ monitors stating which user has occupied the KVM. The button in the message board is shadowed and this icon displays next to the occupying user’s name in the User List of all users’ message boards.
	Occupy/Release Keyboard/Mouse – When you occupy the KVM, other users can see the video, but cannot input keyboard or mouse data. The button is shadowed and this icon displays next to the occupying user’s name in the User List of all users’ message boards.
	Show/Hide User List – When the User List is hidden, the User List panel closes. The button is shadowed when the User List is open.

### User List Panel

- The names of all users logged in appear in the User List panel. Select the names of the user(s) that you wish to communicate with before sending your message.
- If a user has disabled chat, its icon displays before that user’s name.
- If a user has occupied the KVM or the KM, the corresponding icon displays before that user’s name.

### Compose Panel

Type your message into this panel and then click the Send button or press [Enter] to post the message to the message board.

**Note:** You must select the user to communicate with from the user list. To send a message to all users, simply click All Users in the user list.

### Message Display Panel

Messages that users post to the board, as well as system messages, display in this panel. If chat is disabled, messages that get posted do not appear.



**Ctrl – Alt – Delete** – Sends the [Ctrl, Alt, Delete] command to the remote computer.



**Set to Grayscale** – Displays the remote video in grayscale. On slower networks, displaying the remote video in grayscale can help improve keyboard and mouse response time.



**Zoom** – Zooms in on the remote display at 100%, 75%, 50% or 25%. Checking the 1:1 box will keep the screen contents sized in a 1:1 ratio, regardless of remote session display percentage.

**Note:** This feature is only available in windowed mode (Full Screen Mode is off).



**On-Screen Keyboard** – The B030-008-17-IP features an on-screen keyboard, available in multiple languages, with all of the standard keyboard keys for each language. Click this icon to display the on-screen keyboard.

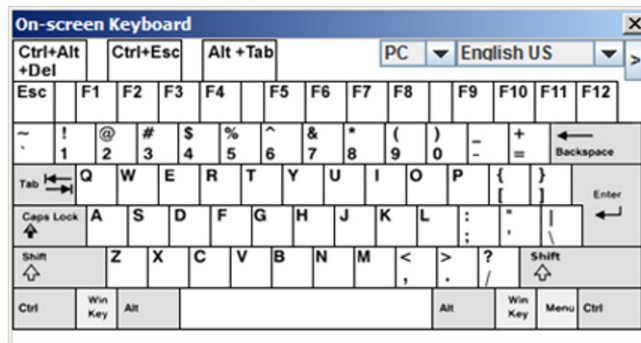

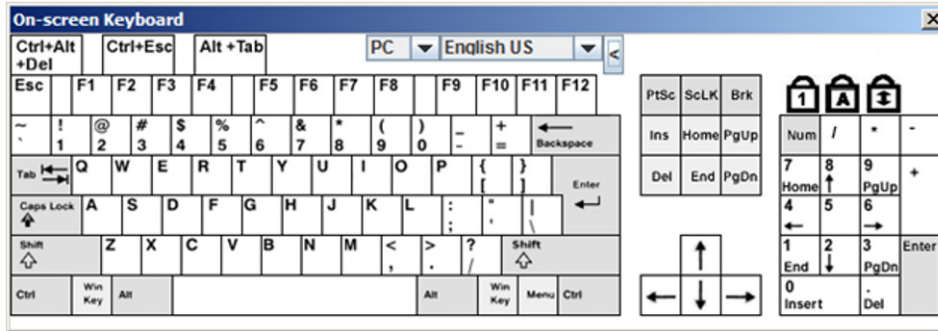

- To switch to a different language keyboard, open the drop-down list on the upper-right dropdown of the on-screen keyboard and select the desired language.
- To expand the keyboard to include the number pad, click on the arrow icon to the right of the language drop-down menu.

## 18. Remote Session Operation



**Mouse Pointer** – Click to choose how the local and remote mouse pointers are displayed. You can choose to display Dual mouse pointers, Crosshairs mouse pointers, the local mouse pointer as a tiny dot, or only the remote mouse pointer. Dual mouse pointers display both local and remote mice as arrows. Crosshairs pointers display the local mouse as a cross and the remote mouse pointer as an arrow. When displaying the local mouse pointer as a tiny dot, the remote mouse pointer will be displayed as an arrow.

**Mouse Sync Mode** – Toggles between automatic and manual mouse sync modes. When set to automatic, the  icon appears in the toolbar. When set to manual, the  icon appears. When set to Automatic for Mac, the  icon appears.

**Note:** This feature is only available for Windows and Mac systems (G4 and higher) whose adapter attribute OS setting is configured for Win or Mac. All other configurations must use manual mouse synchronization.

### Mac Considerations

For Mac OS versions 10.4.11 and higher, a second DynaSync setting to choose from is available. If the default Mouse DynaSync result is not satisfactory, try the Mac 2 setting. To select Mac 2, right click in the text area of the Control Panel and select Mouse Sync Mode → Automatic for Mac 2:

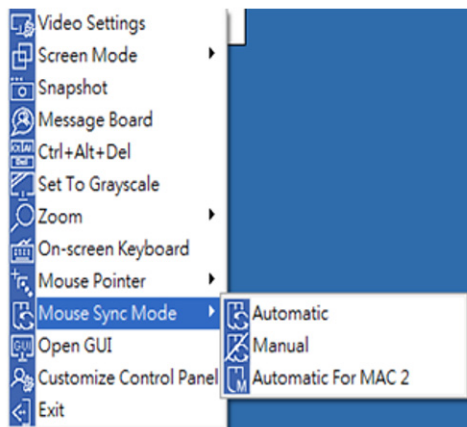

### Manual Mouse Synchronization

If the local mouse pointer goes out of sync with the remote system's mouse pointer, there are a number of methods to bring it back into sync. Before trying any mouse synchronization procedures, it is always recommend to first go to the Mouse Properties Settings and set them accordingly. The Mouse Properties Settings should be set on the computers attached to the KVM Switch, not the computer you are using to access.

**Note:** In order for the local and remote mice to synchronize, a generic mouse driver supplied with the MS operating system must be used. If a third party driver is installed - such as one supplied by the mouse manufacturer – it must be removed.

### Windows 2000:

1. Open the *Mouse Properties* dialog box
2. Click the *Motion* tab
3. Set the mouse speed to the middle position (6 devices in from the left)
4. Set the mouse acceleration to *None*

## 18. Remote Session Operation

Windows XP and later:

1. Open the *Mouse Properties* dialog box
2. Click the *Pointer Options* tab
3. Set the mouse speed to the middle position (6 devices in from the left)
4. Disable *Enhance Pointer Precision*

Sun / Linux:

Open a terminal session and issue the following command:

Sun: `xset m 1`

Linux: `xset m 0`

### Mouse Synchronization Procedures

If you are experiencing syncing problems after adjusting the mouse properties, try the following methods to help synchronize the local and remote mouse pointers.

**Note:** *Mouse synchronization may require several seconds to take effect. Wait for 15 to 30 seconds to ensure the mouse has had sufficient time to sync.*

- When in a remote session, move the mouse pointer to the upper-center of the screen to open the control panel, and then move it back into the remote screen. The mouse pointers should align.
- Drag the control panel to a different position on the screen.
- When in a remote session, move the pointer into all 4 corners of the screen (in any order).
- Perform a Video Auto Sync by right-clicking on the *Video Settings* icon in the control panel. In most cases, the local and remote mouse pointers will sync following the video auto sync.
- Invoke the Adjust Mouse hotkey command (see the Hotkeys section in **13.1 Control Panel** for more information). This hotkey command defaults to F8, F7, F6.
- Adjust the video settings to decrease the amount of information being transferred over the network. The less data that is being sent, the faster the response time. In particular, the Quality and Detect Tolerance settings in the Video Settings screen (see Video Settings section in **13.1 Control Panel** for more information) can help improve keyboard and mouse response time.
- Go to the Network page in the Web Interface and reduce the Network Transfer Rate setting.
- Go to the display settings section of the remote computer and lower the video resolution, refresh rate and color settings.
- If the remote computer has a graphic desktop background, change it to a solid color background.



**First Port** – Skips to the first accessible port on the installation.



**Previous Port** – Skips to the first accessible port prior to the currently selected port.



**Next Port** – Skips to the first accessible port after the currently selected port.



**Last Port** – Skips to the last port on the installation.



**Scan Ports** – Initiates Auto Scan mode.



**Array Mode** – Initiates Panel Array mode. Refer to **18.3 Panel Array Mode** for more information.



**Open GUI** – Opens the Web Interface.



**Customize Control Panel** – Opens the Customize Control Panel screen and allows users to choose which icons are displayed in the control panel. Feature editing is also available.

## 18. Remote Session Operation

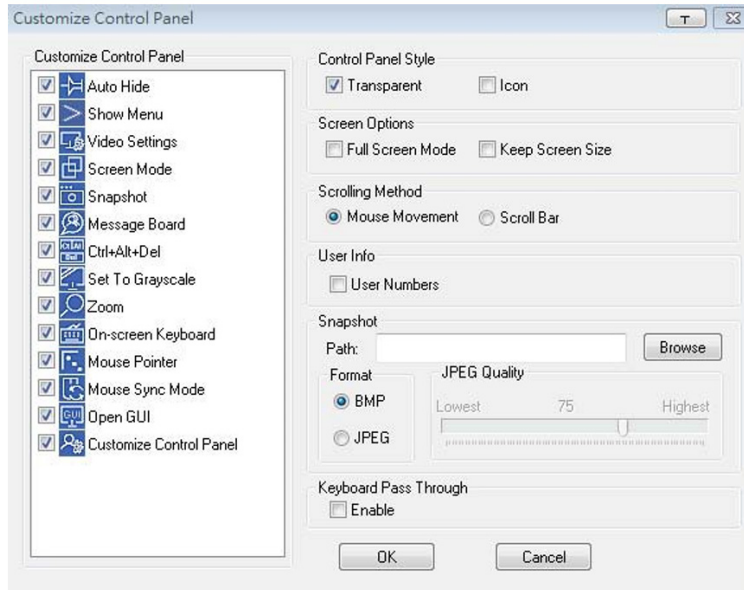

### Control Panel Style

This section lets a user determine how the control panel is displayed when it is dragged out of the default position in the top-center of the screen.

**Note:** A second default position for the control panel is available at the bottom-center of the screen.

- When the *Transparent* box is checked, dragging the control panel away from one of the default locations will leave it displayed transparently in whatever location it was dragged to.
- When the *Icon* box is checked, dragging the control panel away from one of the default locations will leave it displayed as an icon in whatever location it was dragged to.
- When both the *Transparent* and *Icon* boxes are checked, dragging the control panel away from one of the default locations will leave it displayed as a transparent icon in whatever location it was dragged to.
- When neither box is checked, dragging the control panel away from one of the default locations will leave it displayed as normal in whatever location it was dragged to.
- If the control panel is located in the top-center or bottom-center default locations, checking these boxes will have no effect.

### Screen Options

This section enables *Full Screen Mode* and *Keep Screen Size* as the default settings when a remote session is activated.

- Check the *Full Screen Mode* box to display the remote screen in Full Screen Mode for the next time logging in to a remote session.
- Check the *Keep Screen Size* box to enable the *Keep Screen Size* feature for the next time logging in to a remote session.

### Scrolling Method

In instances when the remote screen display is larger than the monitor, you can choose how to scroll to the off-screen areas.

- By selecting *Mouse Movement*, the screen will scroll when moving the mouse pointer to the screen border.
- By selecting *Scroll Bars*, scroll bars appear around the screen borders that available to scroll to the off-screen areas.

### User Info

If *User Info* is enabled, the total number of users remotely accessing the KVM will display on the Control Panel's bottom row.

### Snapshot

The *Snapshot* section determines where snapshots are sent to, what file type they are saved as; and if saved as a JPEG, the quality of the JPEG image.

- *Path* – To select a location for snapshots to be saved, click on the *Browse* button next to the *Path* field and navigate to the desired location.
- *Format* – Check the file type button to select the snapshot format.
- *JPEG Quality* – If saving snapshots as JPEGs, the JPEG image quality can be selected here. The higher the quality of the image, the larger the file size.



# 18. Remote Session Operation

## Keyboard Pass Through

When selected, the [Alt, Tab] function will be sent to the remote computer. When it is not selected, the [Alt, Tab] function is sent to the local computer. It is deactivated by default.



**Exit** – Exits the remote session.



**Lock LEDs** – Display the status of the keyboard Num Lock, Caps Lock and Scroll Lock LEDs. Click the LEDs to toggle the corresponding lock function on/off. When first initiating a remote session, the lock function may first need to toggle off/on to ensure they are synced up with your keyboard.

## 18.2 Remote Session Toolbar

When remotely accessing a port, a secondary toolbar is provided to help control the port switching operations from within that port. There are three hotkey combinations used to access the Remote Session Toolbar and/or Web Interface. When in a remote session:

- Press [Scroll Lock] twice to open the Remote Session Toolbar.
- Press [Scroll Lock] three times to open the Web Interface.
- When the Remote Session Toolbar is opened (see below), press [Scroll Lock] once to open the Web Interface.



Depending on the settings selected for the ID Display in the User Preferences section of the Web Interface, the Port Number and/or Port Name will display on the right of the toolbar.

**Note:** When the toolbar displays, mouse input is confined to the toolbar area and keyboard input (other than the Scroll Lock hotkey) has no effect.

### 18.2.1 Remote Session Toolbar Icons

	Skips to the first accessible port on the installation without needing to invoke the Web Interface.
	Skip to the first accessible port previous to the current one without invoking the Web Interface.
	Begins Auto Scan Mode. The KVM Switch automatically switches among the ports selected for Auto Scanning in the Port Select and Filter functions. This allows the user to monitor their activity without having to switch among them manually.
	Skips the current port to the next accessible port without invoking the Web Interface.
	Skips the current port to the last accessible port on the installation without invoking the Web Interface.
	Opens the Web Interface.
	Closes the Remote Session Toolbar.
	Invokes Panel Array Mode (refer to the <b>18.3 Panel Array Mode</b> for more information.)

## 18. Remote Session Operation

### 18.2.2 Remote Session Toolbar Hotkeys

When the Toolbar is displayed, hotkeys can be used to switch between ports.

Hotkey	Action
←	Skips to the first accessible port before the current port. To control the selected port, press [Esc] or click on the X icon in the Toolbar
→	Skips to the first accessible port after the current port. To control the selected port, press [Esc] or click on the X icon in the Toolbar
↑	Skips the current port to the first accessible port on the installation. To control the selected port, press [Esc] or click on the X icon in the Toolbar
↓	Skips the current port to the last accessible port on the installation. To control the selected port, press [Esc] or click the X icon in the Toolbar
A	Initiates an Auto Scan. To exit Auto Scan and control the currently selected port, press [Esc] or [Spacebar], or click on the X icon in the Toolbar.
P	Pauses an Auto Scan. To resume scanning, press any key other than the [Esc] or [Spacebar]

### 18.3 Panel Array Mode

Clicking the Panel Array icon on the Remote Session Toolbar or Control Panel initiates Panel Array Mode. Under this mode, your screen is divided into a grid of panels:

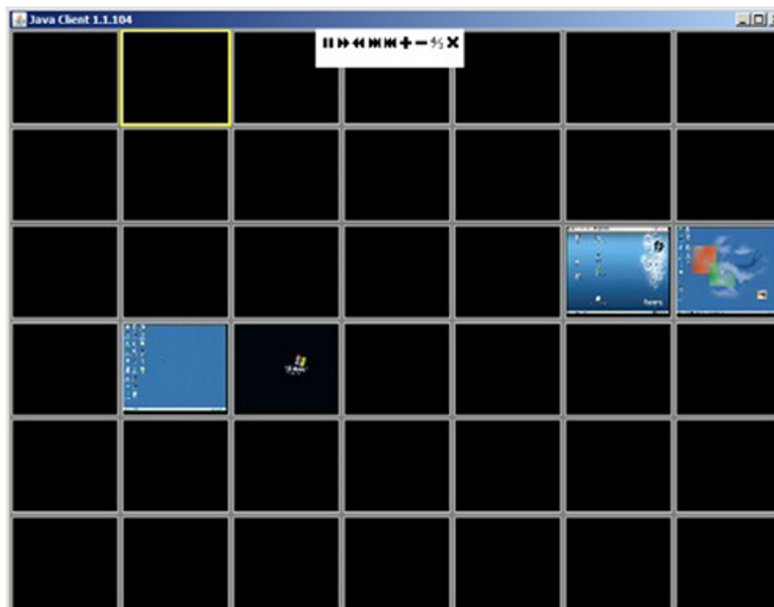

- Each panel represents one port, starting with Port 1 at the upper left, continuing in sequence from left to right and top to bottom.
- When first initiated, the Array scans each of the ports selected for Auto Scanning in the Port Select and Filter functions, and displays information about the port (port name, resolution, online status, port access status) at the bottom of the panel.

**Note:** The Panel Array scans at one-second intervals. The scan interval is not user definable.











The number of panels in the array can be increased or decreased by clicking the Show More Ports or Show Fewer Ports icons on the panel array toolbar.

- If the computer connected to a port is online, its screen will display in the panel. If not, the panel will remain blank.
- Only ports accessible to the currently logged-in user are displayed. For ports that are not accessible, the panel will remain blank.
- If the mouse pointer is positioned over a panel, information about the port will display at the bottom of the panel.
- A computer/server connected to a port can be accessed by positioning the mouse pointer over its panel and double-clicking. This will switch the user to the computer exactly as if he/she had selected it from the OSD Main screen.

## 18. Remote Session Operation

### 18.3.1 Panel Array Toolbar Icons

The Panel Array Toolbar provides shortcut navigation and control of the panel array.

Icon	Description
	Click and drag any part of the toolbar that is not an icon to move the toolbar to another position on the screen.
	Pauses panel scanning so the focus remains on the currently selected panel.
	Moves the focus of the Panel Array scan backward four panels.
	Moves the focus of the Panel Array scan to the previous panel.
	Moves the focus of the Panel Array scan to the next panel.
	Moves the focus of the Panel Array scan forward four panels.
	Increases the number of panels in the array.
	Decreases the number of panels in the array.
	Toggles to a 4:3 aspect ratio.
	Exits Panel Array mode.

## 19. Auto Scan Mode

The Auto Scan function automatically switches among all accessible ports at regular intervals so the user can monitor their activity without having to manually switch between ports. The ports accessed in Auto Scan mode can be further filtered via the Filter section of the Port Access page.

### 19.1 Setting the Scan Interval

The scan interval used during Auto Scan mode can be set in the User Settings menu (refer to User Preferences in **11.2 Port Access** for more information). The scan interval can be set from 1 to 255 seconds. The default is 5 seconds.

### 19.2 Initiating Auto Scan

Auto Scan Mode can be initiated in the Web Interface or a remote session. When in the Web Interface, initiate Auto Scan by clicking on the Auto Scan button in the lower-left corner of the Port Access section. When in a remote session, initiate Auto Scan by opening the Remote Session toolbar and tapping the *A* key. Once started, Auto Scan cycles through the ports in order, starting with the first accessible port on the installation. During Auto Scan Mode, an *S* appears in front of the Port ID Display to indicate the port is being accessed under Auto Scan Mode.

### 19.3 Pausing Auto Scan

Auto Scan Mode can be paused in order to maintain focus on a particular computer by pressing the *P* key during an Auto Scan. When paused, the *S* that displays in front of the Port ID will blink. Pausing to maintain focus on a particular computer may be more convenient than exiting Auto Scan Mode. This is due to the user having to start from where they left off when they resume scanning. If exiting and then restarting Auto Scan Mode, the scanning would start over from the first computer on the installation. To resume Auto Scan Mode after pausing, press any key except [Esc] or [Spacebar], both of which will exit Auto Scan Mode completely.

### 19.4 Exiting Auto Scan









While Auto Scan Mode is in effect, ordinary keyboard functions are suspended. The user must exit Auto Scan Mode in order to regain normal control of the keyboard. To exit Auto Scan Mode, press [Esc] or [Spacebar].

## 20. Appendix

### 20.1 Keyboard Emulation

#### 20.1.1 Mac Keyboard







The PC compatible (101/104 key) keyboard can emulate the functions of the Mac keyboard. The emulation mappings are listed in the table below.

PC Keyboard	Mac Keyboard
[Shift]	Shift
[Ctrl]	Ctrl
	
[Ctrl] [1]	
[Ctrl] [2]	
[Ctrl] [3]	
[Ctrl] [4]	
[Alt]	Alt
[Print Screen]	F13
[Scroll Lock]	F14
	=
[Enter]	Return
[Backspace]	Delete
[Insert]	Help
[Ctrl] 	F15

**Note:** When using key combinations, press and release (Ctrl), then press and release the activation key.

#### 20.1.2 Sun Keyboard

The PC compatible (101/104 key) keyboard can emulate the functions of the Sun keyboard when Control [Ctrl] is used in conjunction with another key. The corresponding functions are shown in the table below.

PC Keyboard	Sun Keyboard
[Ctrl] [T]	Stop
[Ctrl] [F2]	Again
[Ctrl] [F3]	Props
[Ctrl] [F4]	Undo
[Ctrl] [F5]	Front
[Ctrl] [F6]	Copy
[Ctrl] [F7]	Open
[Ctrl] [F8]	Paste
[Ctrl] [F9]	Find
[Ctrl] [F10]	Cut
[Ctrl] [1]	
[Ctrl] [2]	
[Ctrl] [3]	
[Ctrl] [4]	
[Ctrl] [H]	Help
	Compose
	

**Note:** When using key combinations, press and release (Ctrl), then press and release the activation key.

## 20. Appendix

### 20.2 Troubleshooting

#### 20.2.1 General Operation

Problem	Action
Erratic Operation.	<p>If a KVM switch is cascaded from it, the upper-level KVM must always be powered on before the lower-level KVM. If the cascaded switch was turned on first, resetting it may resolve the issue. If not, power off the installation and power everything on according to the installation instructions in this manual.</p> <ul style="list-style-type: none"> <li>Reset the unit by pressing and holding the Reset button on the front of the unit for longer than three seconds.</li> </ul>
I can't access the KVM, even though I specified the IP address and port number correctly.	<p>If the KVM is behind a router, the router's Port Forwarding (also referred to as Virtual Server) feature must be configured.</p>
Mouse and/or Keyboard not responding.	<ul style="list-style-type: none"> <li>If accessing the KVM via local console, unplug and re-plug the cable(s) from the console port(s).</li> <li>Turn the connected computer/server off and then back on. All connected devices need to be powered off when connecting to the KVM.</li> </ul>
Sudden loss of network connection.	<p>Close your KVM connection. Wait approximately 30 seconds, then log in again.</p>
No video display on the remote console.	<ul style="list-style-type: none"> <li>Make sure the monitor resolution displaying the remote computer/server is higher than the remote computer/server.</li> <li>Make sure the OSD toolbar is closed. Mouse movement is often required to bring the screen out of sleep mode. If the OSD toolbar is open, your mouse input is not being received by the remote computer/server.</li> </ul>
When logging in from a browser, the following message appears: 404 Object Not Found.	<p>If a login string has been set (refer to <b>13.3 Login String</b> for more information), make sure to include the forward slash and correct login string when specifying the KVM's IP address.</p>
When I log in, the browser generates a CA Root certificate is not trusted, or a Certificate Error response.	<p>The certificate can be trusted; you can proceed.</p>
There are two mouse pointers after the remote system is accessed.	<p>The KVM automatically defaults to show both the local and remote mouse pointers. You can choose to display both mouse pointers at the same time or only the remote mouse pointer.</p>
The remote console display is distorted and performing Autosync does not resolve the problem.	<ul style="list-style-type: none"> <li>Switch to a port with a different resolution, then switch back.</li> <li>Lower the resolution and refresh rate for the computer/server connected to the port.</li> </ul>
I have been given an account, but I am unable to login	<ul style="list-style-type: none"> <li>Make sure you have correctly entered your username and password.</li> <li>Make sure your System Administrator has given you proper access to the KVM switch.</li> </ul>
The Lock LEDs on the Control Panel do not accurately reflect my Lock status	<p>Click the Control Panel LEDs until they match those on your keyboard. Once matched up, changing a Lock LED on the keyboard will also change it in the Control Panel and vice versa.</p>
When I open a viewer, the web page does not display properly and I receive an error message that says "Problems with this Web page might prevent it from being displayed properly...."	<ul style="list-style-type: none"> <li>By default, IE6 and some versions of IE5 use the High security level for the Restricted Sites zone. Windows Server 2003 uses High security for both the Restricted Sites and Internet zones. You may need to enable Active Scripting, ActiveX Controls and Java Applets. To do this, follow these steps: 1) In Internet Explorer, open the <i>Tools</i> menu and select <i>Internet Options</i>. 2) In the <i>Internet Options</i> dialog box, click <i>Security</i>. 3) Click <i>Default</i> level, then click <i>OK</i> when prompted.</li> <li>Verify that Active Scripting, ActiveX Controls and Java Applets are not blocked. If some client computers work and others does not, verify the Internet Explorer or another program (e.g. antivirus, firewall, etc.) on your client computer are not configured to block Scripts, ActiveX Controls or Java Applets.</li> <li>Verify your anti-virus program is not set to scan the <i>Temporary Internet Files</i> or <i>Downloaded Program Files</i> folders.</li> <li>Delete all temporary internet related files by following these steps: 1) Open the <i>Tools</i> menu in Internet Explorer and select <i>Internet Options</i>, 2) Click on the <i>General</i> tab, 3) Under <i>Temporary Internet Files</i>, click <i>Settings</i>, 4) Click <i>Delete Files</i> and click <i>OK</i> when prompted, 5) Click <i>Delete Cookies</i> and click <i>OK</i> when prompted, 6) Under <i>History</i>, click on <i>Clear History</i>, <i>Yes</i> and click <i>OK</i> when prompted.</li> <li>Make sure you have the latest version of Microsoft DirectX installed.</li> <li>Make sure that you have the latest version of Java installed.</li> </ul>

## 20. Appendix

### 20.2.2 Administration

Problem	Action
After upgrading the firmware and logging back in, the KVM appears to still be using the old firmware version.	Clear your browser's cache. Delete all temporary internet files and cookies. Close the browser and reopen it to log in with a new session.

### 20.2.3 Mouse

Problem	Action
Mouse movement is extremely slow.	There is too much data transmission in your connection. <ul style="list-style-type: none"><li>• If the remote computer's wallpaper contains a substantial amount of graphics, switch it to a plain wallpaper.</li></ul>
There are two mouse pointers on my screen, how do I change this?	You can choose between three different pointer types. Refer to the Mouse Pointer section in <b>18.1 Control Panel</b> for more information.
My mouse pointers do not sync.	Refer to the Mouse Pointer section in <b>18.1 Control Panel</b> for more information.

### 20.2.4 AP Windows Client

Problem	Action
Windows Client will not connect to the KVM.	DirectX 8.0 or higher must be installed on your computer.
Remote mouse pointer is out of sync.	<ul style="list-style-type: none"><li>• Perform a Video Auto Sync (refer to Video Settings section in <b>18.1 Control Panel</b> for more information). This will usually sync the local and remote mouse pointers.</li><li>• Use the Adjust Mouse Hotkey command (refer to the Hotkeys section in <b>18.1 Control Panel</b> for more information).</li><li>• If this does not work, refer to the Mouse Pointer section in <b>18.1 Control Panel</b> for more information.</li></ul>
Part of the remote window is off my monitor.	<ul style="list-style-type: none"><li>• If Keep Screen Size is not enabled (refer to the Screen Mode section for more information), try performing a Video Auto Sync to sync the local and remote monitors. If this does not work, you may have to manually adjust the Screen Position in the Video Settings screen.</li><li>• If Keep Screen Size is enabled, areas that are off the screen can be accessed by positioning the mouse pointer on the far side of the area you want to scroll to.</li></ul>
The remote screen is rotated 90 degrees.	Enable Keep Screen Size (refer to <b>18.2 Control Panel</b> for more information).
I cannot run Net Meeting when the Windows Client is running.	Enable Keep Screen Size (refer to <b>18.2 Control Panel</b> for more information).
My KVM is not showing up in the device list when I open the AP Windows Client.	<ul style="list-style-type: none"><li>• The port number entered into the Program field of your KVM's Network page (refer to <b>7.6.2 IP Installer</b> for more information) must match the port number entered into the AP Windows Client's Port field. Only KVMs matching the port number entered into this field will show up in the device list.</li><li>• The Enable Device List option must be checked on the Operating Mode page for your KVM switch to show up in the Device List (refer to <b>11.12.2 Device Management</b> for more information).</li></ul>
After upgrading the firmware to my KVM switch, the AP Windows Client no longer works.	The old .ocx file version was not deleted. Open Explorer and search for <i>WinClient.ocx</i> . Delete all occurrences.

## 20. Appendix

### 20.2.5 WinClient ActiveX Viewer

Problem	Action
The WinClient ActiveX Viewer will not connect to the KVM switch.	DirectX 8.0 or higher must be installed on your client computer.
After upgrading the firmware to my KVM switch, the WinClient ActiveX Viewer no longer works.	The old .ocx file version was not deleted. Open Explorer and search for <i>WinClient.ocx</i> . Delete all occurrences.
Part of the remote window is off my monitor.	<ul style="list-style-type: none"> <li>If Keep Screen Size is not enabled (refer to <b>18.1 Control Panel</b> for more information), try performing a Video Auto Sync. If this does not work, you may have to manually adjust the video via the Video Settings page.</li> <li>If Keep Screen Size is enabled, areas that are off the screen can be accessed by positioning the mouse pointer on the far side of the area you want to scroll to.</li> </ul>
The remote screen is rotated 90 degrees.	Enable the Keep Screen Size function (refer to <b>18.1 Control Panel</b> for more information).
I cannot run Net Meeting when the WinClient is running.	Enable the Keep Screen Size function (refer to <b>18.1 Control Panel</b> for more information).
After logging in, I cannot open the WinClient ActiveX viewer.	<ul style="list-style-type: none"> <li>You do not have the authority to install the WinClient Control Add-on on your client computer. Have your system administrator run the program for you.</li> <li>Under Vista, you must also add the KVM switches URL to the list of trusted sites. Go to Tools &gt; Internet Options &gt; Security &gt; Trusted Sites &gt; Sites.</li> </ul>
When using Vista, I open the WinClient ActiveX Viewer and try to mount a driver or removable disk, but I am receiving a message that says "Driver not ready."	This is due to Vista's User Account Control (UAC). If you are the computer's administrator, open your browser by right-clicking and selecting <i>Run as Administrator</i> . If you are not the administrator, you will need to have the administrator disable UAC.

### 20.2.6 Panel Array Mode

Problem	Action
The video resolution is low quality.	This occasionally occurs when the screens are scaled down to fit into each panel. Decrease the number of panels displayed.
When multiple remote users are logged in, some only receive a partial image.	The first user to invoke Panel Array Mode should set it to display at least four panels.

### 20.2.7 Java Applet and AP Java Client

Problem	Action
The AP Java Client won't connect to the KVM.	<ul style="list-style-type: none"> <li>Java Runtime Environment 6, Update 3 or higher must be installed on your computer.</li> <li>If a login string has been set, make sure to include the forward slash and correct string (refer to <b>13.3 Login String</b> for more information) when specifying the KVM's IP address.</li> <li>Try closing and reopening the Java client.</li> </ul>
Pressing the Windows Menu key has no effect.	Java does not support the Windows Menu key.
Java Client performance deteriorates.	Exit the program and start again.
National language characters do not appear.	You must set the appropriate keyboard language in the Port Properties tab of the Port Access page (refer <b>11.2.1 Connections</b> for more information).
After upgrading my KVM's firmware and logging into the OSD, my switch still shows the old firmware version number.	You need to delete your Java temporary internet files. Open Control Panel > Java, and click on the <i>Settings</i> button in Temporary Internet Files. In the Disk Space section, click on <i>Delete Files</i> . When prompted, click <i>OK</i> .
When I try to add a folder to be mounted as a Virtual Media Drive, I am unable to select the folder. The only option I have is desktop.	In the folder selection entry field, enter the root directory of the folder you want to add. After that, the folders contained under the root directory will be displayed.



## 20. Appendix

### 20.2.8 Log Server

Problem	Action
The Log Server program does not run.	<p>The Log Server requires the Microsoft Jet OLEDB 4.0 driver in order to access the database. This driver is automatically installed with Windows ME, 2000 and XP. For Windows 98 or NT, go to the Microsoft download site:</p> <p><a href="http://www.microsoft.com/data/download.htm">http://www.microsoft.com/data/download.htm</a> to retrieve the driver file: MDAC 2.7 RTM Refresh (2.70.9001.0).</p> <p>Since this driver is used in Windows Office Suite, an alternate method of obtaining it is to install Windows Office Suite. Once the driver file or Suite has been installed, the Log Server will run.</p>

### 20.2.9 Sun Systems

Problem	Action
Video display problems with HD15 interface systems (e.g. Sun Blade 1000 servers).*	<ul style="list-style-type: none"><li>The display resolution should be set to 1024 x 768 @ 60 Hz:</li></ul> <p><b>Under Text Mode</b>, go to OK mode and issue the following command: <code>setenv output-device screen:r1024x768x60 reset-all</code></p> <p><b>Under XWindow:</b></p> <ol style="list-style-type: none"><li>Open a console and issue the following command: <code>m64config -res 1024x768x60</code></li><li>Log out</li><li>Log in</li></ol>
Video display problems with 13W3 interface systems (e.g. Sun Ultra servers).*	<ul style="list-style-type: none"><li>The display resolution should be set to 1024 x 768 @ 60 Hz:</li></ul> <p><b>Under Text Mode</b>, go to OK mode and issue the following command: <code>setenv output-device screen:r1024x768x60 reset-all</code></p> <p><b>Under XWindow:</b></p> <ol style="list-style-type: none"><li>Open a console and issue the following command: <code>m64config -res 1024x768x60</code></li><li>Log out</li><li>Log in</li></ol>
The local and remote mouse pointers do not sync.	See Manual Sync Mode section in <b>18.1 Control Panel</b> for more information.

\* These solutions work for most common Sun VGA cards. If using them fails to resolve the problem, consult the Sun VGA card's manual.

## 20. Appendix

### 20.3 Specifications

Model	B030-008-17-IP	B030-DP08-17DIP	B030-DP16-17DIP
Model Description	8-Port 1U Rack-Mount Console HDMI KVM Switch with 17 in. LCD and IP Remote Access	8-Port 1U Rack-Mount Console DisplayPort KVM Switch with 17 in. LCD and IP Remote Access, Dual Rail	16-Port 1U Rack-Mount Console DisplayPort KVM Switch with 17 in. LCD and IP Remote Access, Dual Rail
Port Selection Methods	Pushbutton, OSD, Web Interface / Toolbar	Pushbutton, OSD, Hotkey, Web Interface / Toolbar	Pushbutton, OSD, Hotkey, Web Interface / Toolbar
External Console Ports	HDMI (Female), 2 x USB-A (Female)	Displayport (Female), 2 x USB-A (Female)	Displayport (Female), 2 x USB-A (Female)
Computer Ports	8	8	16
RJ45 LAN Ports	1	1	1
Housing	Metal, Dual-Rail	Metal, Dual-Rail	Metal, Dual-Rail
Power LEDs	1 x Green	1 x Green	1 x Green
Online LEDs	8 x Orange	8 x Orange	16 x Orange
Selected LEDs	8 x Green	8 x Green	16 x Green
Power Input Connector	IEC-320-C14	IEC-320-C14	IEC-320-C14
I/P Rating	100-240V, 50/60 Hz 1A	100-240V, 50/60 Hz 1A	100-240V, 50/60 Hz 1A
On/Off Power Switch	Yes	Yes	Yes
Additional USB Ports	1 (USB 1.1)	1 (USB 1.1)	1 (USB 1.1)
Reset Button	Yes	Yes	Yes
Port Selection Pushbuttons	8	8	16
Keyboard/Mouse Emulation	USB (PC, Mac, Sun)	USB (PC, Mac, Sun)	USB (PC, Mac, Sun)
Max Video Resolution (Local and 2nd Console) <b>Remote Console does not support HDCP</b>	1920 x 1080 @ 60 Hz, DDC2B, HDCP 1.4	1920 x 1080 @ 60 Hz, DDC2B, HDCP 1.4	1920 x 1080 @ 60 Hz, DDC2B, HDCP 1.4
Operating Temperature Range	32°F to 104°F / 0°C to 40°C	32°F to 104°F / 0°C to 40°C	32°F to 104°F / 0°C to 40°C
Storage Temperature Range	-4°F to 140°F / -20°C to 60°C	-4°F to 140°F / -20°C to 60°C	-4°F to 140°F / -20°C to 60°C
Humidity	0 to 80% RH, Non-condensing	0 to 80% RH, Non-condensing	0 to 80% RH, Non-condensing
Dimensions (H x W x D)	1.74 x 18.9 x 26.77 in. / 44 x 480 x 680 mm	1.74 x 18.90 x 26.77 in. / 44 x 480 x 680 mm	1.74 x 18.9 x 26.77 in. / 44 x 480 x 680 mm
Weight	26 lb. / 11.8 kg	30.62 lb. / 13.89 kg	30.69 lb. / 13.92 kg

### 20.4 OSD Factory Default Settings

Setting	B030-008-17-IP	B030-DP08-17DIP	B030-DP16-17DIP
OSD Hotkey	[Scroll Lock] [Scroll Lock]	[Scroll Lock] [Scroll Lock]	[Scroll Lock] [Scroll Lock]
Port ID Display Duration	3 Seconds	3 Seconds	3 Seconds
Port ID Display Mode	Port Number + Port Name	Port Number + Port Name	Port Number + Port Name
Scan Duration	5 Seconds	5 Seconds	5 Seconds
Screen Blanker	0 (Disabled)	0 (Disabled)	0 (Disabled)
Logout Timeout	30 Minutes	30 Minutes	30 Minutes
Beeper	Y (Enabled)	Y (Enabled)	Y (Enabled)

# 21. Warranty and Product Registration

## 3-Year Limited Warranty

TRIPP LITE warrants its products to be free from defects in materials and workmanship for a period of three (3) years from the date of initial purchase. TRIPP LITE's obligation under this warranty is limited to repairing or replacing (at its sole option) any such defective products. To obtain service under this warranty, you must obtain a Returned Material Authorization (RMA) number from TRIPP LITE or an authorized TRIPP LITE service center. Products must be returned to TRIPP LITE or an authorized TRIPP LITE service center with transportation charges prepaid and must be accompanied by a brief description of the problem encountered and proof of date and place of purchase. This warranty does not apply to equipment which has been damaged by accident, negligence or misapplication or has been altered or modified in any way.

EXCEPT AS PROVIDED HEREIN, TRIPP LITE MAKES NO WARRANTIES, EXPRESS OR IMPLIED, INCLUDING WARRANTIES OF MERCHANTABILITY AND FITNESS FOR A PARTICULAR PURPOSE. Some states do not permit limitation or exclusion of implied warranties; therefore, the aforesaid limitation(s) or exclusion(s) may not apply to the purchaser.

EXCEPT AS PROVIDED ABOVE, IN NO EVENT WILL TRIPP LITE BE LIABLE FOR DIRECT, INDIRECT, SPECIAL, INCIDENTAL OR CONSEQUENTIAL DAMAGES ARISING OUT OF THE USE OF THIS PRODUCT, EVEN IF ADVISED OF THE POSSIBILITY OF SUCH DAMAGE. Specifically, TRIPP LITE is not liable for any costs, such as lost profits or revenue, loss of equipment, loss of use of equipment, loss of software, loss of data, costs of substitutes, claims by third parties, or otherwise.

## PRODUCT REGISTRATION

Visit [tripplite.com/warranty](http://tripplite.com/warranty) today to register your new Tripp Lite product. You'll be automatically entered into a drawing for a chance to win a FREE Tripp Lite product!\*

\* No purchase necessary. Void where prohibited. Some restrictions apply. See website for details.

## Regulatory Compliance Identification Numbers

For the purpose of regulatory compliance certifications and identification, your Tripp Lite product has been assigned a unique series number. The series number can be found on the product nameplate label, along with all required approval markings and information. When requesting compliance information for this product, always refer to the series number. The series number should not be confused with the marketing name or model number of the product.

## WEEE Compliance Information for Tripp Lite Customers and Recyclers (European Union)



Under the Waste Electrical and Electronic Equipment (WEEE) Directive and implementing regulations, when customers buy new electrical and electronic equipment from Tripp Lite they are entitled to:

- Send old equipment for recycling on a one-for-one, like-for-like basis (this varies depending on the country)
- Send the new equipment back for recycling when this ultimately becomes waste

Tripp Lite has a policy of continuous improvement. Specifications are subject to change without notice. Photos and illustrations may differ slightly from actual products.



1111 W. 35th Street, Chicago, IL 60609 USA • [tripplite.com/support](http://tripplite.com/support)