

Eaton Tripp Lite SmartOnline Series

Rack / Tower Advanced Users Guide

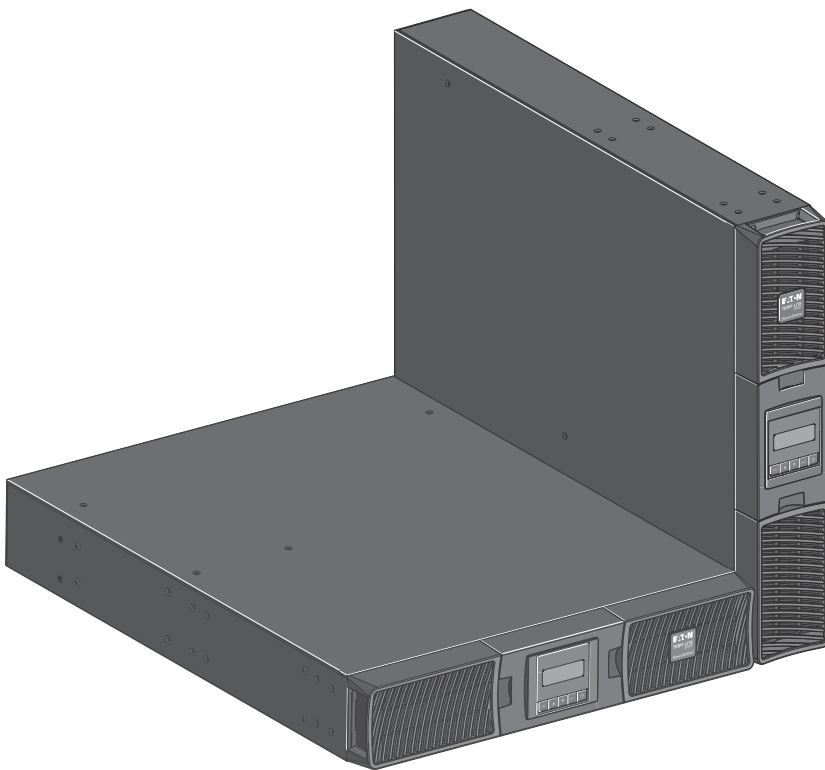

SU750RTXLCD2U
SU750RTXLCD2UN
SU1000RTXLCD2U
SU1000RTXLCD2UN
SU1500RTXLCD2U
SU1500RTXLCDN
SU2200RTXLCD2U
SU2200RTXLCDN
SU3000RTXLCD2U
SU3000RTXLCD2UN
SUINT1000LCD2U
SUINT1500LCD2U
SUINT2200LCD2U
SUINT3000LCD2U
BP36RT
BP48RT
BP72RT

EATON

Powering Business Worldwide

p/n: 614-21325
Revision 03

Safety Instructions

SAVE THESE INSTRUCTIONS. This manual contains important instructions that should be followed during installation and maintenance of the UPS and batteries.

This equipment has been tested and found to comply with the limits for a Class A digital device, pursuant to Part 15 of the FCC Rules. These limits are designed to provide reasonable protection against harmful interference when the equipment is operated in a commercial environment. This equipment generates, uses, and can radiate radio frequency energy and, if not installed and used in accordance with the instruction manual, may cause harmful interference to radio communications. Operation of this equipment in a residential area is likely to cause harmful interference in which case the user will be required to correct the interference at his own expense.



This is a category C2 UPS product. In a residential environment, this product may cause radio interference, in which case the user may be required to take additional measures.

Supplier's Declaration of Conformity of Federal Communications Commission Statement

This device complies with Part 15 of the FCC Rules. Operation is subject to the following two conditions:

1. this device may not cause harmful interference, and
2. this device must accept any interference received, including interference that may cause undesired operation.

For questions regarding this FCC SDoC declaration, contact Eaton Corporation by telephone or through the Internet.

Eaton Corporation 8609 Six Forks Road,
Raleigh, NC 27615, USA
Telephone: 800-356-5794

Special Symbols

The following are examples of symbols used on the product to alert you to important information:



RISK OF ELECTRIC SHOCK - Observe the warning associated with the risk of electric shock symbol.



CAUTION: REFER TO OPERATOR'S MANUAL - Refer to your operator's manual for additional information, such as important operating and maintenance instructions.



This symbol indicates that you should not discard the UPS or the UPS batteries in the trash. This product contains sealed lead acid batteries and must be disposed of properly. For more information, contact your local recycling/reuse or hazardous waste center.



This symbol indicates that waste electrical and electronic equipment as well as waste batteries and accumulators should not be discarded together with unseparated household waste, but must be collected separately. The product should be handed in for recycling in accordance with the local environmental regulations for waste disposal. By separating waste electrical and electronic equipment as well as waste batteries and accumulators, you will help reduce the volume of waste sent for incineration or land-fills and minimize any potential negative impact on human health and environment.

Safety of Persons

- The system has its own power source (the battery). Consequently, the power outlets may be energized even if the system is disconnected from the AC power source. Dangerous voltage levels are present within the system. It should be opened exclusively by qualified service personnel.
- The system must be properly grounded at all times.
- The battery supplied with the system contains small amounts of toxic materials. To avoid accidents, the directives listed below must be observed:
 - Servicing of batteries should be performed or supervised by personnel knowledgeable about batteries and the required precautions.
 - When replacing batteries, replace with the same type and number of batteries or battery packs.
 - Do not dispose of batteries in a fire. The batteries may explode.
 - Batteries constitute a danger (electrical shock, burns). The short-circuit current may be very high.
- Precautions must be taken for all handling:
 - Wear rubber gloves and boots.
 - Do not lay tools or metal parts on top of batteries.
 - Disconnect charging source prior to connecting or disconnecting battery terminals.
 - Determine if battery is inadvertently grounded. If inadvertently grounded, remove source from ground. Contact with any part of a grounded battery can result in electrical shock. The likelihood of such shock can be reduced if such grounds are removed during installation and maintenance (applicable to equipment and remote battery supplies not having a grounded supply circuit).

Product Safety

- To connect the UPS, instructions and operation described in the manual must be followed in the indicated order.
- CAUTION - To reduce the risk of fire, the unit connects only to a circuit provided with 20 or 30 amperes maximum branch circuit overcurrent protection in accordance with the National Electric Code, ANSI/NFPA 70 (US installations only).
- Check that the indications on the rating plate correspond to your AC powered system and to the actual electrical consumption of all the equipment to be connected to the system.
- For PLUGGABLE EQUIPMENT, the socket-outlet shall be installed near the equipment and shall be easily accessible
- Never install the system near liquids or in an excessively damp environment.
- Never let a foreign body penetrate inside the system.
- Never block the ventilation grates of the system.
- Never expose the system to direct sunlight or source of heat.
- If the system must be stored prior to installation, storage must be in a dry place.
- The admissible storage temperature range is -25°C to +55°C without batteries, 0°C to 40°C with batteries.
- The system is not for use in a computer room AS DEFINED IN the standard for the Protection of Information Technology Equipment, ANSI/NFPA 75 (US installations only).

Special Precautions

- The unit is heavy: wear safety shoes and use vacuum lifter preferentially for handling operations.
- All handling operations will require at least two people (unpacking, lifting, installation in rack system).
- Before and after the installation, if the UPS remains de-energized for a long period, the UPS must be energized for a period of 24 hours, at least once every 6 months (for a normal storage temperature less than 25°C). This charges the battery, thus avoiding possible irreversible damage.
- During the replacement of the Battery Module, it is imperative to use the same type and number of element as the original Battery Module provided with the UPS to maintain an identical level of performance and safety. If there are any questions, don't hesitate to contact your local Eaton representative.
- All repairs and service should be performed by AUTHORIZED SERVICE PERSONNEL ONLY. There are NO USER SERVICEABLE PARTS inside the UPS.
- For potential safety issue on defective UPS : DISCONNECT INTERNAL BATTERY for storage and transportation.

Table of Contents

1 Presentation	1
1.1 Introduction.....	1
1.2 Environmental Protection	1
1.3 Standard Installations	3
1.4 Rear Panels	4
2 Installation	7
2.1 Inspecting the Equipment.....	7
2.2 Checking the Accessory Kit	7
2.3 Connecting the Internal Battery	9
2.3.1 UPS Tower Installation.....	9
2.3.2 UPS Rack Installation.....	10
2.4 SmartOnline External Battery Pack Installation.....	11
2.4.1 External Battery Rackmount Installation.....	11
2.4.2 Extended Battery Pack Rackmount Connections	12
2.4.3 UPS and Extended Battery Pack Tower Installation	13
2.4.4 Extended Battery Pack Tower Connections	14
3 Interfaces and Communication	15
3.1 Control Panel.....	15
3.2 LCD Description	16
3.3 UPS Home Menu	17
3.4 Display Functions	18
3.5 User Settings.....	20
3.6 Communication Ports.....	23
3.7 Remote Control Functions.....	24
3.8 Tripp Lite By Eaton PowerAlert Software Suite	28
3.9 Cybersecurity	28
4 Operation.....	29
4.1 Start-up and Normal operation	29
4.2 Starting the UPS on Battery	29
4.3 UPS Shutdown	29
4.4 Operating Modes	29
4.5 Return of AC Power	30
4.6 Setting High Efficiency mode	30
4.7 Configuring the Battery Settings	31
4.8 Retrieving the Event Log.....	31
5 UPS Maintenance.....	33
5.1 Equipment Care	33
5.2 Storing the Equipment.....	33

Table of Contents

5.3 When to Replace Batteries	33
5.4 Replacing batteries	33
5.5 Recycling the used equipment	36
6 Troubleshooting	37
6.1 Typical Alarms and Faults	37
6.2 Silencing the Alarm	41
6.3 Service and Support	41
7 Specifications	43
7.1 Model Specifications	43

Chapter 1 Presentation

1.1 Introduction

Thank you for selecting an Tripp Lite by Eaton product to protect your electrical equipment.

The Tripp Lite by Eaton SmartOnline UPS range has been designed with the utmost care.

We recommend that you take the time to read this manual to take full advantage of the many features of your UPS (Uninterruptible Power System).

Before installing your UPS, please read the booklet presenting the safety instructions. Then follow the indications in this manual.

To discover the entire range of products and the options available for the Tripp Lite by Eaton SmartOnline UPS range visit our web site at Tripp Lite.com or contact your Tripp Lite by Eaton representative.

1.2 Environmental Protection

Tripp Lite by Eaton has implemented an environmental-protection policy.

Products are developed according to an eco-design approach.

Substances

This product does not contain CFCs, HCFCs, or asbestos.

Packing

To improve waste treatment and facilitate recycling, separate the various packing components.

- The cardboard we use comprises over 50% of recycled cardboard.
- Sacks and bags are made of polyethylene.

- Packing materials are recyclable and bear the appropriate identification symbol



Table 1. Packing Material Symbols

Materials	Abbreviations	Number in the symbols
Polyethylene terephthalate	PET	01
High-density polyethylene	HDPE	02
Polyvinyl chloride	PVC	03
Low-density polyethylene	LDPE	04
Polypropylene	PP	05
Polystyrene	PS	06

Follow all local regulations for the disposal of packing materials.

End of Life

Tripp Lite by Eaton will process products at the end of their service life in compliance with local regulations. Tripp Lite by Eaton works with companies in charge of collecting and eliminating our products at the end of their service life.

Product

The product is mainly made up of recyclable materials.

Dismantling and destruction must take place in compliance with all local regulations concerning waste. At the end of its service life, the product must be transported to a processing center for electrical and electronic waste.

Battery

The product contains lead acid (Pb) batteries that must be processed according to applicable local regulations concerning batteries.

The battery may be removed to comply with regulations and in view of correct disposal.

The Tripp Lite by Eaton SmartOnline power system (UPS) protects your sensitive electronic equipment from the most common power problems, including power failures, power sags, power surges, brownouts, line noise, high voltage spikes, frequency variations, switching transients, and harmonic distortion.

Power outages can occur when you least expect it and power quality can be erratic. These power problems have the potential to corrupt critical data, destroy unsaved work sessions, and damage hardware causing hours of lost productivity and expensive repairs.

With the Tripp Lite by Eaton SmartOnline power system, you can safely eliminate the effects of power disturbances and guard the integrity of your equipment. Providing outstanding performance and reliability, the Tripp Lite by Eaton SmartOnline power system unique benefits include:

- True online double-conversion technology with high power density, utility frequency independence, and generator compatibility.
- Selectable High Efficiency mode of operation.
- Standard communication options: one RS-232 communication port, one USB communication port, and relay output contacts.
- Optional connectivity cards with enhanced communication capabilities.
- Extended runtime with up to four Extended Battery Modules (EBMs) per UPS.
- Remote On/Off control through Remote On/Off (ROO) and Remote Power Off (RPO) ports.
- Backed by worldwide agency approvals.

1.3 Standard Installations

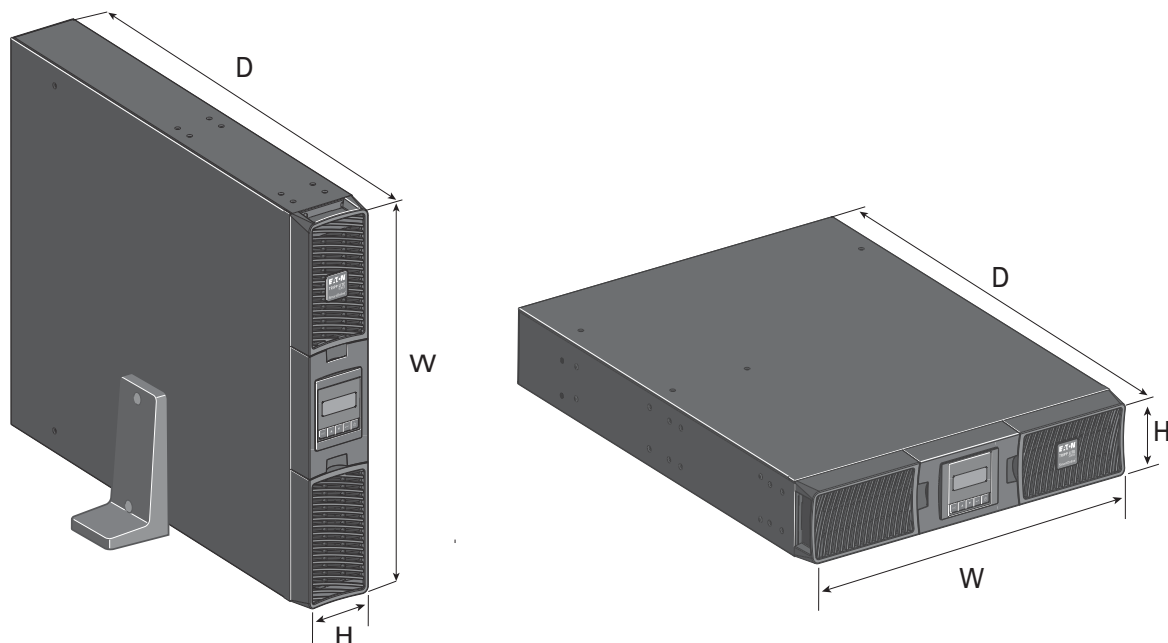

Table 2. Weights and Dimensions

Model	Weight (lb / kg)	Dimensions D x W x H(inch/mm)
SU750RTXLCD2U / SU750RTXLCD2UN	36.4 / 16.5	17.7 x 17.3 x 3.4 / 450 x 440 x 86.5
SU1000RTXLCD2U / SU1000RTXLCD2UN	36.4 / 16.5	17.7 x 17.3 x 3.4 / 450 x 440 x 86.5
SU1500RTXLCD2U / SU1500RTXLCDN	42.5 / 19.3	17.7 x 17.3 x 3.4 / 450 x 440 x 86.5
SU2200RTXLCD2U / SU2200RTXLCDN	61.6 / 27.9	23.8 x 17.3 x 3.4 / 605 x 440 x 86.5
SU3000RTXLCD2U / SU3000RTXLCD2UN	63 / 28.6	23.8 x 17.3 x 3.4 / 605 x 440 x 86.5
SU1NT1000LCD2U	36.4 / 16.5	17.7 x 17.3 x 3.4 / 450 x 440 x 86.5
SU1NT1500LCD2U	41.4 / 18.8	17.7 x 17.3 x 3.4 / 450 x 440 x 86.5
SU1NT2200LCD2U	59.7 / 27.1	23.8 x 17.3 x 3.4 / 605 x 440 x 86.5
SU1NT3000LCD2U	61.2 / 27.8	23.8 x 17.3 x 3.4 / 605 x 440 x 86.5
BP36RT	48.1 / 21.8	17.7 x 17.3 x 3.4 / 450 x 440 x 86.5
BP48RT	59.5 / 27	17.7 x 17.3 x 3.4 / 450 x 440 x 86.5
BP72RT	86.4 / 39.2	23.8 x 17.3 x 3.4 / 605 x 440 x 86.5

1.4 Rear Panels

Figure 1. UPS Rear Panels

SU750RT / SU1000RT / SU1500RT

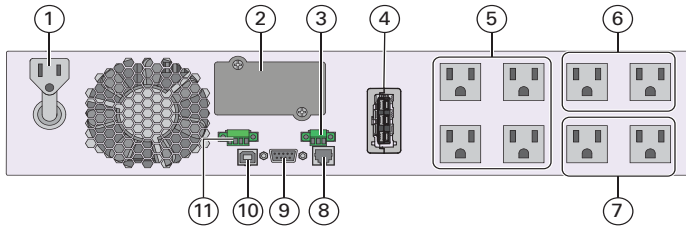

SU2200RT

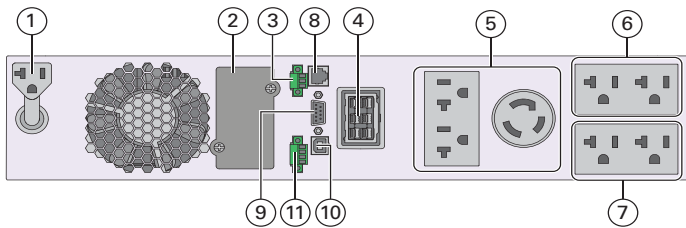

SU3000RT

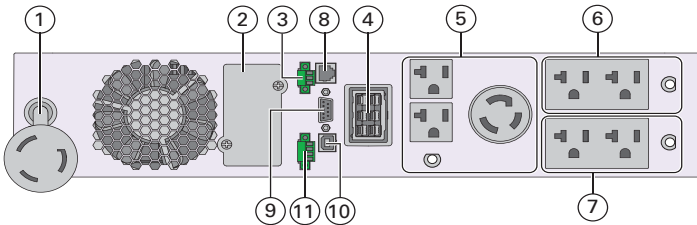

SUINT1000RT / SUINT1500RT

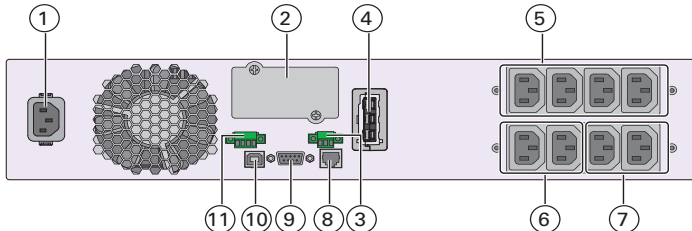

SUINT2200RT / SUINT3000RT

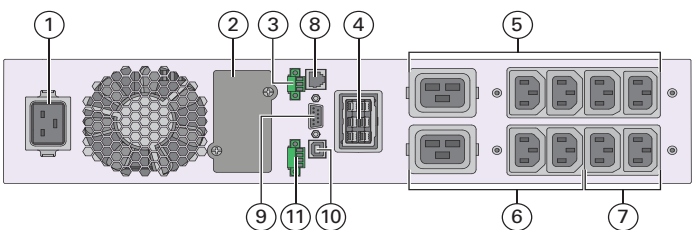

- ① Socket for connection to AC power source
- ② Slot for optional communication card
- ③ Relay output contact
- ④ Connector for additional battery module
- ⑤ Primary group: outlets for connection of critical equipment
- ⑥ Group 1: programmable outlets for connection of equipment
- ⑦ Group 2: programmable outlets for connection of equipment
- ⑧ Connector for automatic recognition of an additional battery module
- ⑨ RS232 communication port
- ⑩ USB communication port
- ⑪ Connector for ROO (Remote On/Off) control and RPO (Remote Power Off)

(*) Primary and Grouped outlets (⑤, ⑥, ⑦) are protected by 20A circuit breakers.

Figure 2. Extended Battery Module Back Panels

BP36RT/BP48RT

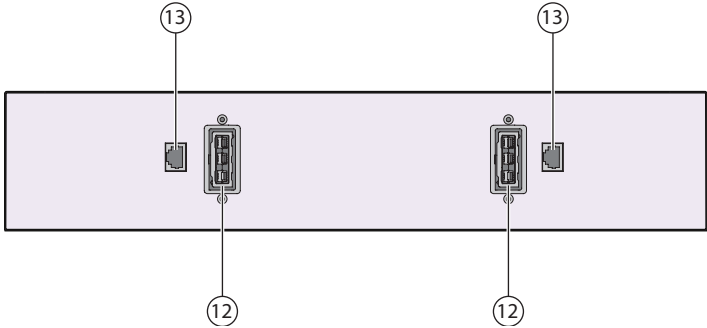

- ⑫ Connectors for battery modules (to the UPS or to the other battery modules)
- ⑬ Connectors for automatic recognition of battery modules

BP72RT

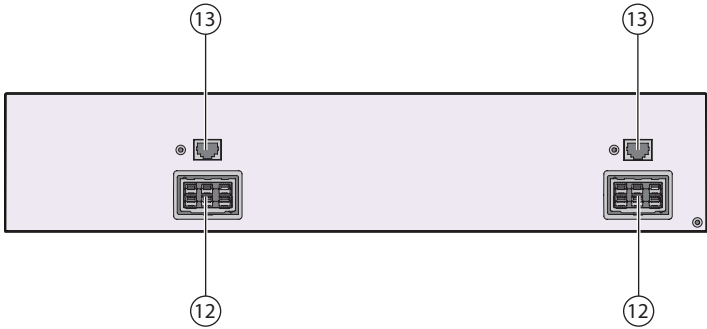

Table 3. UPS Accessories

Part number	Description
BP36RT BP48RT BP72RT	Extended Battery Module
RK2PC	SmartOnline 2- Post Rack Kit
LXE Communication Card	Network Card
EBMCBL36	2m cable 36V EBM
EBMCBL48	2m cable 48V EBM
EBMCBL72	2m cable 72V EBM

Chapter 2 Installation

2.1 Inspecting the Equipment

If any equipment has been damaged during shipment, keep the shipping cartons and packing materials for the carrier or place of purchase and file a claim for shipping damage. If you discover damage after acceptance, file a claim for concealed damage.

To file a claim for shipping damage or concealed damage:

1. File with the carrier within 15 days of receipt of the equipment;
2. Send a copy of the damage claim within 15 days to your service representative.



NOTE

Check the battery recharge date on the shipping carton label. If the date has passed and the batteries were never recharged, do not use the UPS. Contact your service representative.

2.2 Checking the Accessory Kit

- Verify that the following additional items are included with the UPS:

Figure 3. SU750RT / SU1000RT / SU1500RT / SU2200RT / SU3000RT

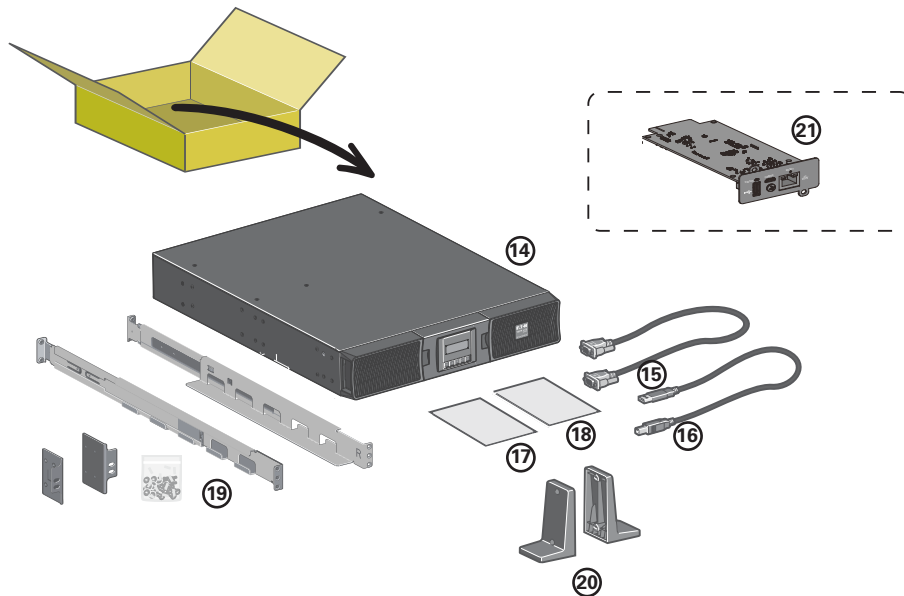

Verify that the following additional items are included with the UPS:

- | | |
|---------------------------------------|--|
| ⑭ SmartOnline UPS | ⑳ 2 supports for tower position |
| ⑮ RS232 communication cable | Elements supplied depending on the version or optional: |
| ⑯ USB communication cable | ⑳ LXE communication card (optional, standard on Network Bundle models) |
| ⑰ Safety instructions | |
| ⑱ Quick start | |
| ⑲ Mounting kit for 19-inch enclosures | |

Figure 4. SUI1000RT / SUI1500RT / SUI2200RT / SUI3000RT

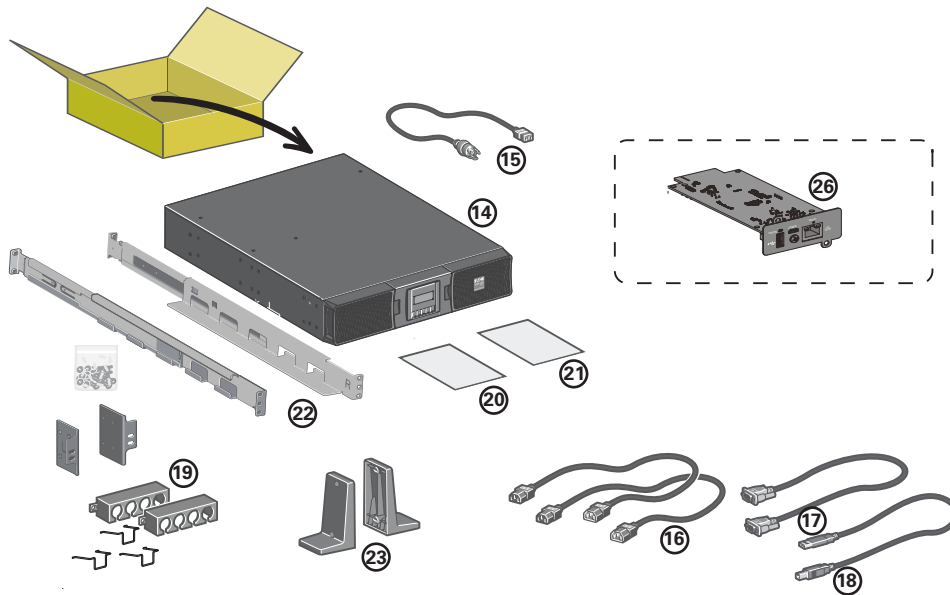

Verify that the following additional items are included with the UPS:

- | | |
|---|---|
| ⑭ SmartOnline UPS | ⑳ Quick start |
| ⑮ Connection cable to AC-power source | ㉑ Mounting kit for 19-inch enclosures |
| ⑯ 2 connection cables for the protected equipment | ㉒ 2 supports for tower position |
| ⑰ RS232 communication cable | Elements supplied depending on the version or optional |
| ⑱ USB communication cable | ㉓ LXE communication card(optional,standard on Network Bundle options) |
| ㉒ 3 cable locking systems | |
| ㉓ Safety instructions | |

Figure 5. BP Accessory Kit

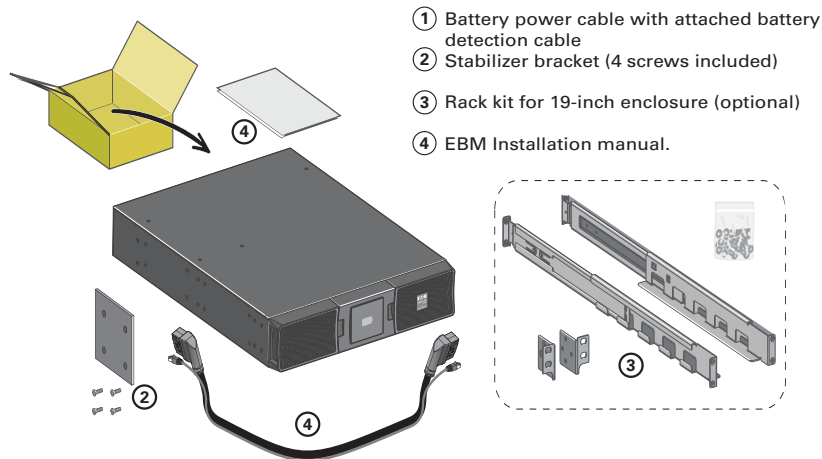

- ① Battery power cable with attached battery detection cable
- ② Stabilizer bracket (4 screws included)
- ③ Rack kit for 19-inch enclosure (optional)
- ④ EBM Installation manual.

2.3 Connecting the Internal Battery



NOTE 1 Place the UPS on a flat, stable surface in its final location.

NOTE 2 Always keep 150 mm of free space behind the UPS rear panel.

Figure 6. Internal Battery Connection

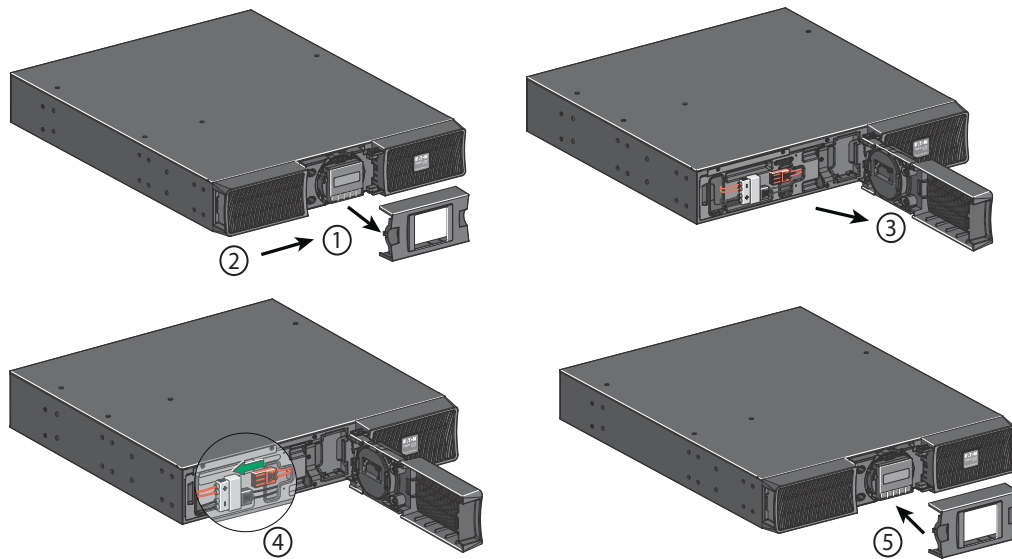

1. Remove the center cover of the front panel.
2. Push left cover toward to right direction.
3. Open the left side of the front panel.



NOTE A ribbon cable connects the LCD control panel to the UPS. Do not pull on the cable or disconnect it.

⚠ CAUTION

A small amount of arcing may occur when connecting the internal batteries. This is normal and will not harm personnel. Connect the cables quickly and firmly.

4. Connect the two battery connectors together.
5. Put back the front panel, then clip the center cover.

2.3.1 UPS Tower Installation

Tip If you ordered other UPS accessories, refer to specific user manuals to check the tower installation with the UPS.

To install the cabinet:

1. Place the UPS on a flat, stable surface in its final location.
2. Always keep 6" or 150 mm of free space behind the UPS rear panel for ventilation.

3. If installing additional cabinets, place them next to the UPS in their final location.

Figure 7. UPS Tower Install

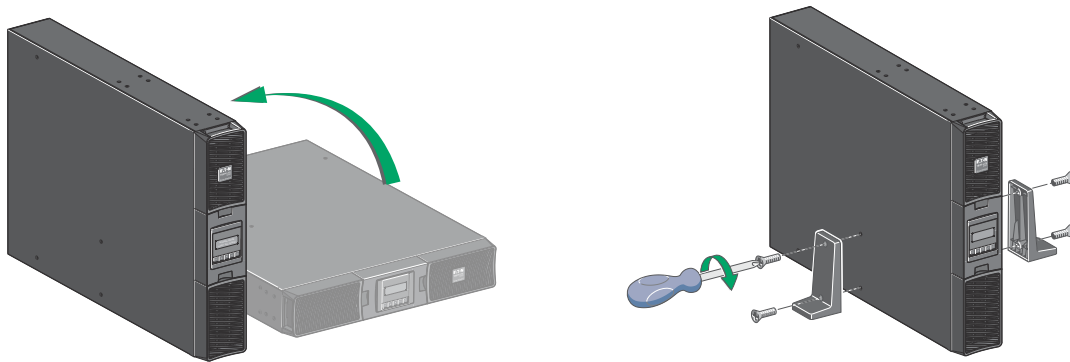

- Adjustment of the orientation of the LCD panel and of the logo.

Figure 8. Adjusting the LCD

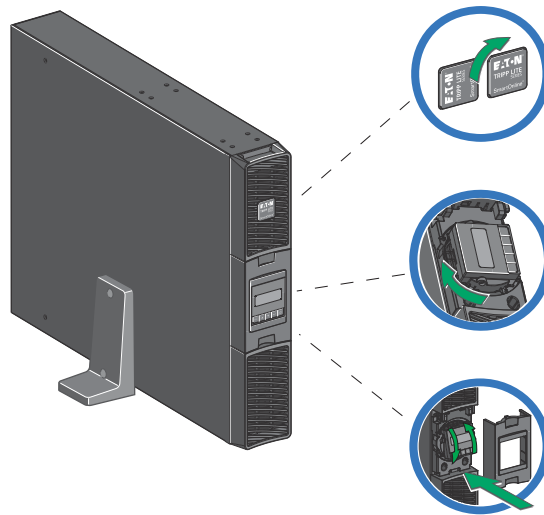

2.3.2 UPS Rack Installation

- Rack mounting of UPS, EBM, and accessory modules.

Follow steps 1 to 4 for module mounting on the rails.

Figure 9. Rack Installation

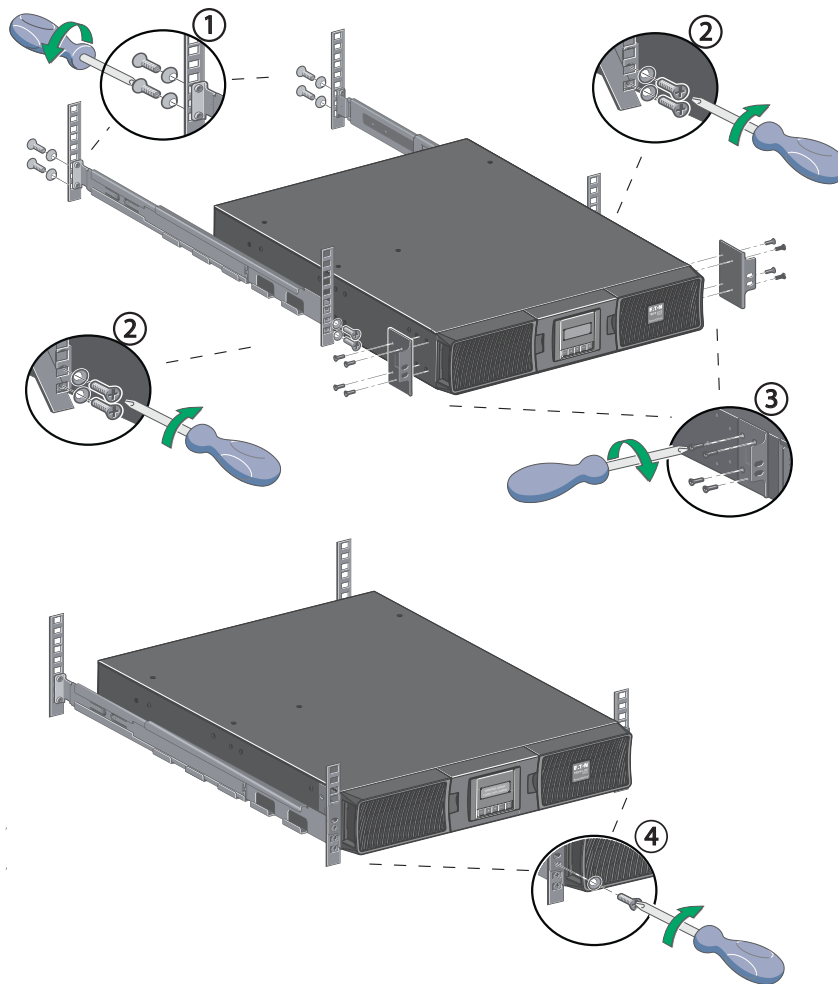

The rails and necessary hardware are supplied by Eaton.

2.4 SmartOnline External Battery Pack Installation

2.4.1 External Battery Rackmount Installation

⚠ CAUTION

The external battery pack is heavy, wear safety shoes. Handling of the external battery pack will require at least two people for installation.

To rack mount the external battery pack follow the steps below:

Figure 10. External Battery Pack Rack Installation

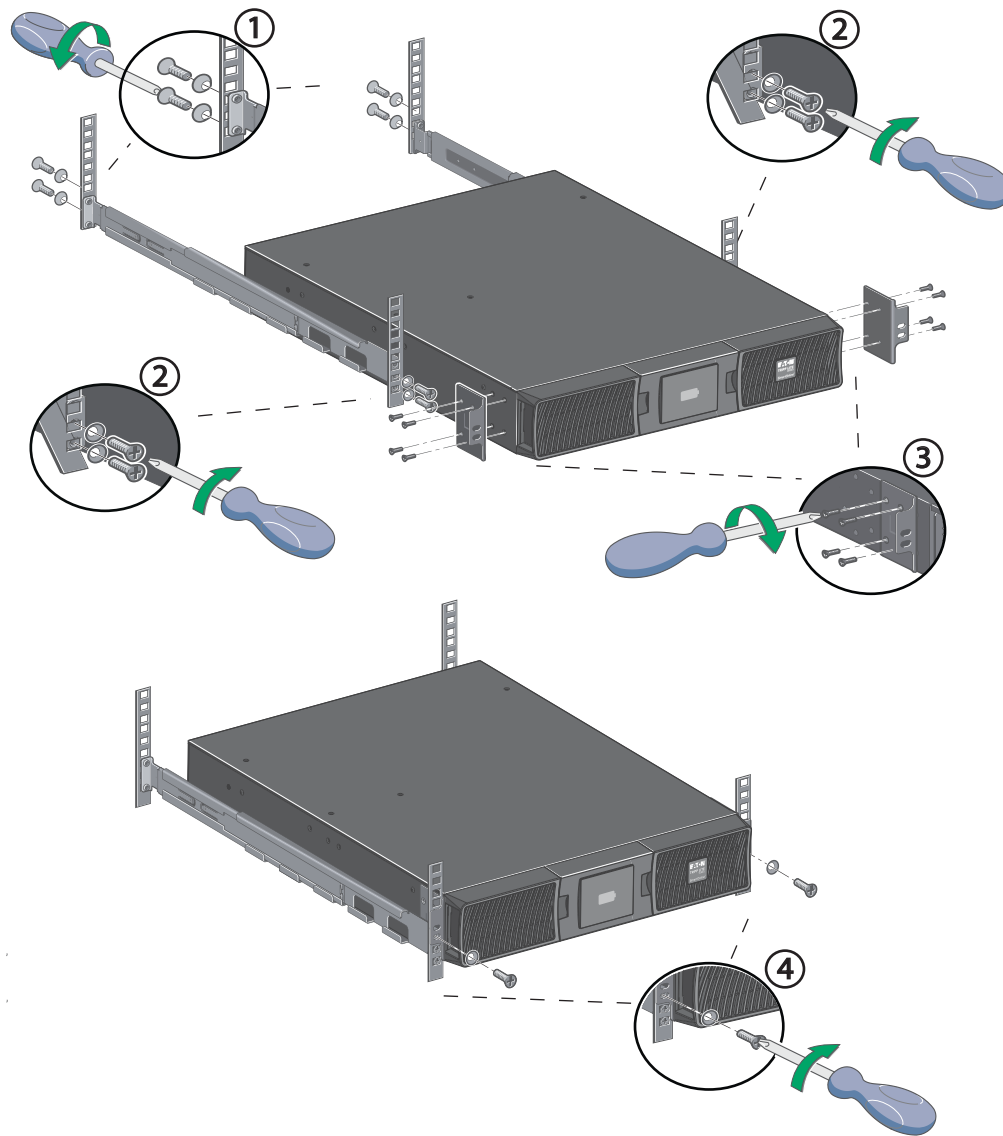

2.4.2 Extended Battery Pack Rackmount Connections



NOTE

A small amount of arcing may occur when connecting an external battery pack to the UPS. This is normal and will not harm personnel.

To connect the external battery packs to the UPS:

1. Insert the external battery pack cable into the UPS battery connector quickly and firmly.
2. Plug the external battery pack power cable(s) into the external battery connector(s) and repeat until all external battery packs are connected. Up to 4 external battery packs may be connected to the UPS. See [Figure 11](#).

3. Verify that the external battery pack connections are tight and that adequate bend radius and strain relief exist for each cable.
4. Connect the battery detection cable(s) to the connector of the UPS and of the external battery pack(s).

Figure 11. Rackmount External Battery Pack Connections

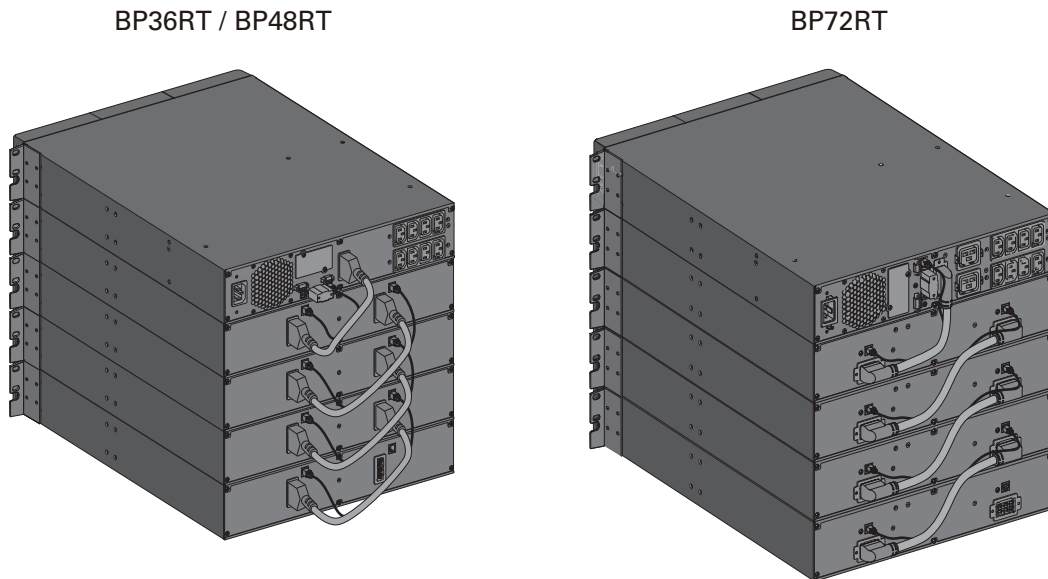

2.4.3 UPS and Extended Battery Pack Tower Installation

Tip If you ordered other UPS accessories, refer to specific user manuals to check the tower installation with the UPS.

Figure 12. UPS and Extended Battery Pack Tower Installation

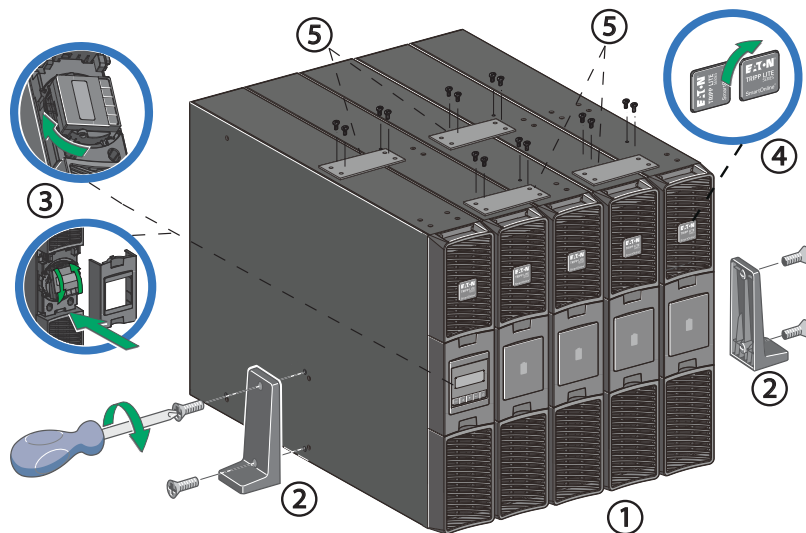

To install the cabinets:

1. Place the UPS and external battery pack(s) on a flat, stable surface in their final location in the tower orientation. If installing additional external battery cabinets, place them next to the UPS.
2. Attach the mounting feet and stabilizer brackets.
3. Adjust the LCD on the UPS.
4. Rotate the logo on the UPS and external battery packs into the correct orientation.
5. Attach the extended battery pack stabilizer brackets to each cabinet.
6. Always keep 6" or 150 mm of free space behind the UPS rear panel for ventilation.

2.4.4 Extended Battery Pack Tower Connections



NOTE

A small amount of arcing may occur when connecting an external battery pack to the UPS. This is normal and will not harm personnel.

To connect the external battery packs to the UPS:

1. Insert the external battery pack cable into the UPS battery connector quickly and firmly.
2. Plug the external battery pack power cable(s) into the external battery connector(s) and repeat until all external battery packs are connected. Up to 4 external battery packs may be connected to the UPS. See [Figure 13](#).
3. Verify that the external battery pack connections are tight and that adequate bend radius and strain relief exist for each cable.
4. Connect the battery detection cable(s) to the connector of the UPS and of the external battery pack(s).

Figure 13. Tower Mount External Battery Pack Connections

BP36RT / BP48RT

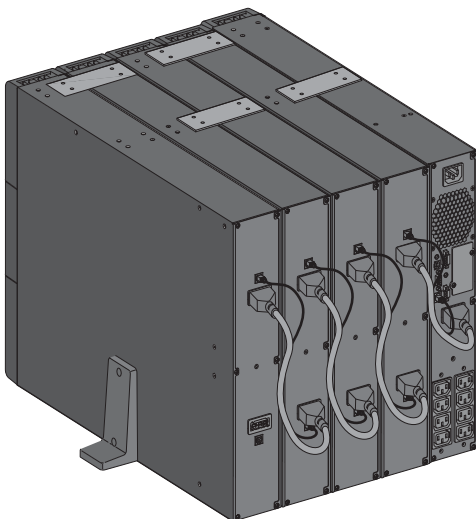

BP72RT

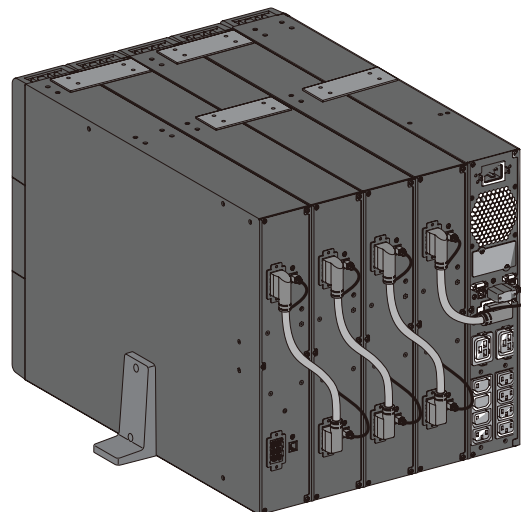



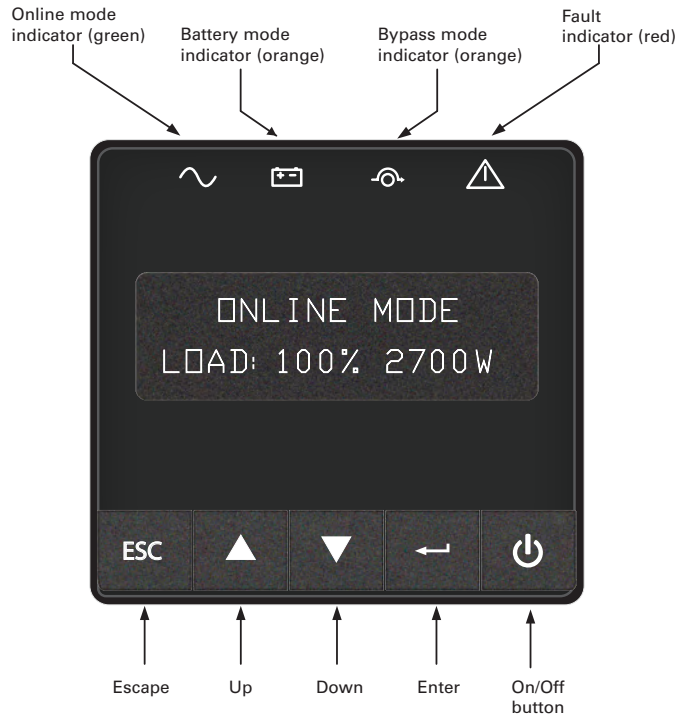

Chapter 3 Interfaces and Communication

3.1 Control Panel

Figure 14. Control Panel



Indicator	Status	Description
 Green	On	The UPS is operating normally on Online, on High Efficiency mode or on battery mode.
 Orange	On	The UPS is on Battery mode.
 Orange	On	The UPS is on Bypass mode.
 Red	On	The UPS has an active alarm or fault.

3.2 LCD Description

The LCD screen has 2 lines, each line has 16 characters. The first line shows UPS status, the second line shows measures.

After 5 minutes of inactivity, the LCD displays the screen saver, and the LCD backlight automatically dims. Press any button to restore the screen.

Note: If fault or alarm appears, the first line of LCD will cycle between fault/alarm message and UPS mode, see troubleshooting page for additional information.

Figure 15. LCD Description

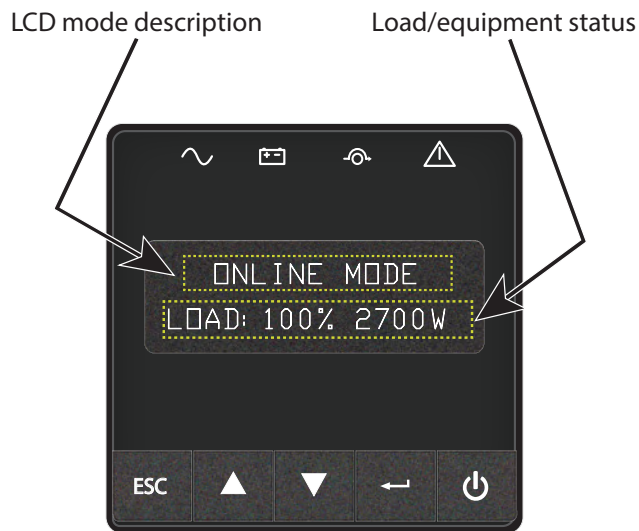

The following table describes the status information provided by the UPS

Note: If other indicator appears, see the troubleshooting for additional information.

Table 4. LCD Operating Modes



UPS Display	Description
<p>STANDBY MODE IN: 120V 60.0HZ</p>	<p>Equipment is not powered until  button is pressed. The UPS is Off, waiting for startup command from user.</p>
<p>ONLINE MODE LOAD: 100% 3000VA</p>	<p>The UPS is powering and protecting the equipment. The UPS is operating normally.</p>
<p>BATTERY MODE RUNTIME: 104MIN</p>	<p>A utility failure has occurred and the UPS is on Battery mode. The UPS is powering the equipment with the battery power. Prepare your equipment for shutdown.</p>

Table 4. LCD Operating Modes (Continued)

UPS Display	Description
	The UPS is operating on High Efficiency mode. The UPS is powering and protecting the equipment
	An overload or a fault has occurred, or a command has been received, and the UPS is in Bypass mode. Equipment is powered but not protected by the UPS.

3.3 UPS Home Menu

The SmartOnline UPS will display the *Home Menu* by default. The *Home Menu* will display the UPS mode and contains nine different types of UPS measurements that can be seen by navigating the menu.

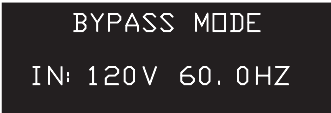
Navigate the *Home Menu* by pressing the ▲ or ▼ buttons on the display.

Press the ESC button to return to the first measurement of the *Home Menu*.

Table 5. UPS Home Menu

Display Information	LCD Display	Bottom Row Values
Displays the UPS mode , load percentage and W.		The LOAD data screen specifies the amount of power that connected equipment is currently using in terms of percentage and Watt.
Displays the UPS mode , load percentage and VA.		The OUTPUT LOAD LEVEL screen indicates the load percentage and VA output load level.
Displays the UPS mode and output load power factor.		The OUTPUT LOAD POWER FACTOR screen indicates the power factor of connected equipment.
Displays the UPS mode , input voltage and frequency.		The INPUT VOLTAGE & FREQUENCY screen displays current UPS input data.
Displays the UPS mode and output voltage and frequency.		The OUTPUT VOLTAGE & FREQUENCY screen displays current UPS output data.
Displays the UPS mode , battery voltage and battery charge percentage.		The BATTERY voltage screen tracks the charge level of your connected battery bank in terms of voltage and charge percentage.

Table 5. UPS Home Menu (Continued)

Display Information	LCD Display	Bottom Row Values
Displays the UPS mode , and remaining battery runtime.		The RUNTIME remaining screen tracks the approximate minutes of runtime available under the current loading and battery pack configuration. The runtime value will automatically re-calculate as connected equipment power consumption changes.
Displays the UPS mode , and external battery quantity.		The EBM screen display external battery quantity.
Displays the UPS mode , and remaining Watts of UPS.		The REMAIN WATTS screen tracks the remaining capacity of the UPS in kilowatt.
Displays the UPS mode and cumulative demand energy by the UPS.		The DEMAND ENERGY screen offers continuous data on the KWh (kilowatt-hour) that connected equipment has consumed in the last one-hour period.

3.4 Display Functions



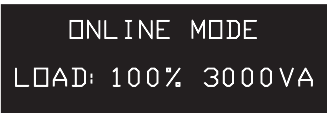
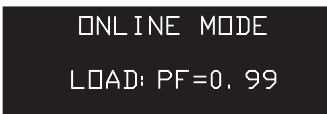
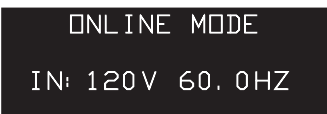
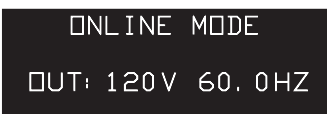
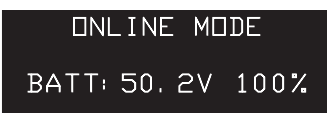
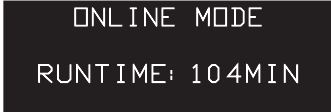
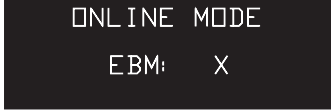
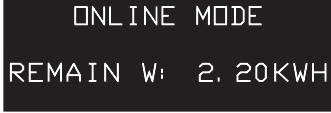
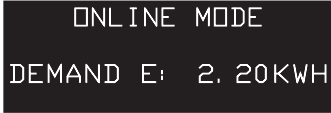

Press the  button from the *UPS Home Menu* to activate the additional menu options. Use the two middle buttons  or  to scroll thru the menu structure. Press the  button to validate the selected item. Pressing the ESC button will exit to the previous menu level / screen.

Table 6. Display Functions

Main Menu	Submenu	Display Information or Menu function
CONTROL	GO TO BYPASS / GO BACK NORMAL	GO TO BYPASS command is used to force ups to bypass mode from ONLINE MODE. GO BACK NORMAL command is used to comeback to line mode from BYPASS MODE.
	BATTERY TEST	BATTERY TEST command is used to start battery test.
	RESET FAULT ST	RESET FAULT ST command is used to reset all faults. But some faults may not be cleared.
	CLEAR EVENT LOG	CLEAR EVENT LOG command is used to clear all the event log.
	RESET KWH USED	RESET KWH USED is used to reset the power used.
	FACTORY SETT	FACTORY SETT command is used to restore factory settings.

Table 6. Display Functions (Continued)

Main Menu	Submenu	Display Information or Menu function
LOCAL SETTINGS	LANGUAGE	User can select language from this submenu.
	AUDIBLE ALARM	Audible alarm can be set through this menu.
IN/OUT SETTINGS	OUTPUT VOLTAGE	Select output voltage through this menu.
	OUTPUT FREQUENCY	Select output frequency through this menu.
	HIGH EFFIC. MODE	Select high efficiency mode enabled or disabled through this menu.
	OVRLD PREALARM	Overload pre-alarm can be set through this menu.
ON/OFF SETTINGS	COLD START	Cold start can be enabled or disabled through this menu.
	AUTO RESTART	Auto restart can be enabled or disabled through this menu.
	AUTO START	Auto start can be enabled or disabled through this menu.
	START ON BYPASS	Start on bypass can be enabled or disabled through this menu.
	SLEEP MODE	Sleep mode can be enabled or disabled through this menu.
	SITE WIRING FLT	Site wiring fault can be enabled or disabled through this menu.
BATTERY SETTINGS	AUTO BAT TEST	Auto battery test period can be set through this menu.
	RESTART LEVEL	Restart battery level can be set through this menu.
	BAT LOW LEVEL	Battery low percentage can be set through this menu.
	BAT LOW TIME	Battery low remaining time can be set through this menu.
COM SETTINGS	REMOTE ON/OFF	Select input signal function for REMOTE ON/OFF.
	REMOTE PWR OFF	Select input signal function for REMOTE PWR OFF.
	INPUT DB9-4	Select input signal function for INPUT DB9-4.
	OUTPUT RELAY	Select output signal function for OUTPUT RELAY.
	OUTPUT DB9-1	Select output signal function for OUTPUT DB9-1.

Table 6. Display Functions (Continued)

Main Menu	Submenu	Display Information or Menu function
	OUTPUT DB9-7	Select output signal function for OUTPUT DB9-7.
	OUTPUT DB9-8	Select output signal function for OUTPUT DB9-8.
EVENT LOG		Event log has 50 items to show what happened.
IDENTIFICATION		This menu shows IDENTIFICATION information.

3.5 User Settings





The following table displays the options that can be changed by the user. From the *UPS Home Menu* press the  button. This will open the *Main Menu Screen*. To select a menu option use the  or  buttons. Press the  button to validate the selected item. Pressing the ESC button will exit to the previous menu level / screen.

Table 7. User Settings

Main Menu Screen	Submenu	Submenu	Menu Function
CONTROL	GO TO BYPASS / GO BACK NORMAL	GO TO BYPASS / GO BACK NORMAL?	GO TO BYPASS command is used to force ups to bypass mode from ONLINE MODE. GO BACK NORMAL command is used to comeback to line mode from BYPASS MODE.
	BATTERY TEST	BATTERY TEST?	BATTERY TEST command is used to start battery test.
	RESET FAULT ST	RESET FAULT ST?	RESET FAULT ST command is used to reset all faults. But some faults may not be cleared.
	CLEAR EVENT LOG	CLEAR EVENT LOG?	CLEAR EVENT LOG command is used to clear all the event log.
	RESET KWH USED	RESET KWH USED?	RESET KWH USED is used to reset the power used.
	FACTORY SETT	FACTORY SETT?	FACTORY SETT command is used to restore factory settings.
LOCAL SETTINGS	LANGUAGE	ENGLISH* (Default) [FRANCAIS] [ESPANOL]	Sets displayed language for Menus, status and alarms. UPS fault, Event log data and settings are in all supported languages.
	AUDIBLE ALARM	ENABLED* (Default) [ENABLED] [DISABLED ON BAT] [ALWAYS DISABLED]	Enables or disables the audible alarm.

Table 7. User Settings (Continued)

Main Menu Screen	Submenu	Submenu	Menu Function
IN / OUT SETTINGS	OUTPUT VOLTAGE	120V* (LV Default) [100V] [110V] [120V] [125V] 208V* (HV Default) [200V] [208V] [220V] [230V] [240V]	Sets the UPS output voltage, UPS must be in standby to choose output voltage setting.
	OUTPUT FREQUENCY	AUTOSENSING* (Default) [AUTO SENSING] [FREQ CONV. 50HZ] [FREQ CONV. 60HZ]	Sets the output frequency, output frequency follows the input frequency,
	HIGH EFFIC. MODE	DISABLED* (Default) [ENABLED] [DISABLED]	Power the output from bypass for high efficiency
	OVERLOAD PREALARM	102%* (Default) [50%] [55%]...[100%][102%]	Load % when overload alarm occurs
ON / OFF SETTINGS	COLD START	ENABLED* (Default) [ENABLED] [DISABLED]	Allows the SmartOnline UPS to start on battery power.
	AUTO RESTART	ENABLED* (Default) [ENABLED] [DISABLED]	Allows the SmartOnline UPS to restart automatically when mains recovers after a complete battery discharge.
	AUTO START	ENABLED* (Default) [ENABLED] [DISABLED]	The SmartOnline UPS starts up as soon as mains power is available.
	START ON BYPASS	ENABLED* (Default) [ENABLED] [DISABLED]	Allows the SmartOnline UPS to start in bypass mode.
	SLEEP MODE	ENABLED* (Default) [ENABLED] [DISABLED]	If Disabled, LCD and communication will turn off immediately after SmartOnline UPS is OFF. If Enabled, LCD and communication stays ON 1h30 min after the SmartOnline UPS is OFF.
	SITE WIRING FLT	ENABLED* (Default) [ENABLED] [DISABLED]	Prevents the SmartOnline UPS from starting in case of phase to neutral wire swapping or improper grounding,
BATTERY SETTINGS	AUTO BAT TEST	MONTHLY*(Default) [NO TEST] [DAILY] [WEEKLY] [MONTHLY]	Allows the SmartOnline UPS to perform an automatic battery test.
	RESTART LEVEL	0%* (Default) [0%]...[100%]	Allows the SmartOnline UPS to restart when the set percentage battery charge is reached.
	BATT LOW LEVEL	0%* (Default) [0%]...[100%]	The alarm triggers when the set percentage of battery charge is reached.

Table 7. User Settings (Continued)

Main Menu Screen	Submenu	Submenu	Menu Function
	BATT LOW TIME	3 MIN* (Default) [0MIN] [3MIN] .. [60MIN]	The alarm triggers when the set battery time remaining is reached.
COM SETTINGS	REMOTE ON /OFF	NO* (Default) [NO] [ROO] [RPO] [BUILDING ALARM] [FORCED BYPASS] [ON GENERATOR] [SHUTDOWN CMD] Delay time and active cannot set by LCD. delay time: 3s active: open	Sets events or fault that will actuate Output signal parameters through external contact connector.
	REMOTE PWR OFF	NO* (Default) [NO] [ROO] [RPO] [BUILDING ALARM] [FORCED BYPASS] [ON GENERATOR] [SHUTDOWN CMD] Delay time and active cannot set by LCD. delay time: 3s active: open	Sets events or fault that will actuate Output signal parameters through external contact connector.
	INPUT DB9-4	NO* (Default) [NO] [ROO] [RPO] [BUILDING ALARM] [FORCED BYPASS] [ON GENERATOR] [SHUTDOWN CMD] Delay time and active cannot set by LCD. delay time: 3s active: open	Sets events or fault that will actuate Output signal parameters through external contact connector or RS232.
	OUTPUT RELAY	BATTERY FAULT* (Default) [ON BATTERY] [LOW BATTERY] [BATTERY FAULT] [BYPASS] [UPS OK] [LOAD PROTECTED] [LOAD POWERED] [GENERAL ALARM] [BAT CHARGING] [OVLd PREALARM] [BAT DISCONN]	Sets events or fault that will actuate Output signal parameters through external contact connector or RS232.
	OUTPUT DB9-1	LOW BATTERY* (Default) [ON BATTERY] [LOW BATTERY] [BATTERY FAULT] [BYPASS] [UPS OK] [LOAD PROTECTED] [LOAD POWERED] [GENERAL ALARM] [BAT CHARGING] [OVLd PREALARM] [BAT DISCONN]	Sets events or fault that will actuate Output signal parameters through external contact connector or RS232.

Table 7. User Settings (Continued)

Main Menu Screen	Submenu	Submenu	Menu Function
	OUTPUT DB9-7	UPS OK* (Default) [ON BATTERY] [LOW BATTERY] [BATTERY FAULT] [BYPASS] [UPS OK] [LOAD PROTECTED] [LOAD POWERED] [GENERAL ALARM] [BAT CHARGING] [OVLD PREALARM] [BAT DISCONN]	Sets events or fault that will actuate Output signal parameters through external contact connector or RS232.
	OUTPUT DB9-8	ON BATTERY* (Default) [ON BATTERY] [LOW BATTERY] [BATTERY FAULT] [BYPASS] [UPS OK] [LOAD PROTECTED] [LOAD POWERED] [GENERAL ALARM] [BAT CHARGING] [OVLD PREALARM] [BAT DISCONN]	Sets events or fault that will actuate Output signal parameters through external contact connector or RS232.

3.6 Communication Ports

Connecting to the RS232 or USB Communication Port

Independent	USB and RS232 are Independent	
Communication Bay	USB	RS-232
Any connectivity card	Available	Available
Any connectivity card	Available	Available

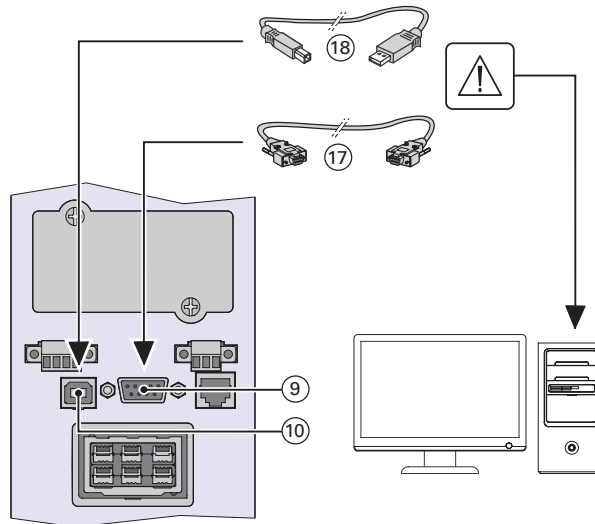

1. Connect the RS232 ⑰ or USB ⑱ communication cable to the serial or USB port on the computer equipment.

Remote Control Functions

- Connect the other end of the communication cable ⑰ or ⑱ to the USB ⑩ or the RS232 ⑨ communication port on the UPS.

The UPS can now communicate with Tripp Lite by Eaton PowerAlert management software.

Characteristics of the contact RS232 Communication Port

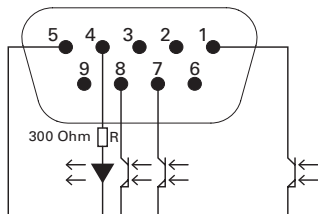

Pin	Signal	Direction	Function
1	Bat Low	Output	Low Battery Output
2	TxD	Output	Transmit to external device
3	RxD	Input	Receive from external device
4	I/P SIG	Input	-
5	GNDS	-	Signal Common tied to chassis
6	PNP	Input	Plug and Play
7	UPS ON	Output	UPS ON
8	BAT Mode	Output	-
9	+5V	Output	Power supply for external signals or options

Contact characteristics (optocoupler)

- Voltage: 48 V DC max
- Current: 25 mA max

3.7 Remote Control Functions

Programmable Signal Inputs

The Tripp Lite by Eaton SmartOnlineUPS incorporates 3 programmable signal inputs: one Remote Power Off (RPO) input terminal, one Remote On/Off (ROO) input terminal, one RS-232 input (pin-4). Signal inputs can be configured see [\(3.5 User Settings\)](#) Settings > Com settings > Signal Input in to have one of the following functions:

Function	Description
No	No function, please choose a function if you want to use input signal
RPO	Remote Power Off (RPO) is used to shutdown the UPS remotely
ROO	Remote On/Off allows remote action of button to switch On/Off the UPS. (Cold start is prohibited while using the ROO function)
Forced bypass	If feeding the load the unit goes to bypass operation and stays there regardless of the bypass state until the input is inactivated
Building alarm	Active input generates an alarm "building alarm"
On generator	Active input disables synchronization and transfers to bypass
Remote shutdown	Active input turns UPS output (or outlet groups) off after a user defined shutdown delay but keeps on charging batteries according to a selected charging scheme, inactive input does not abort shutdown countdown. Depending on the "Restart" parameter the unit may startup automatically. See ON /OFF settings in 3.5 User Settings .

**IMPORTANT**

Warning Signal inputs have no function by default. Please choose a function through the LCD (**COM SETTING->REMOTE ON/OFF, REMOTE PWR OFF, INPUT DB9-4**).

See below 2 examples of configuration with RPO terminal used as RPO function and ROO terminal use as ROO function:

Remote Power Off (RPO)

RPO is used to shutdown the UPS remotely when the contact is open. This feature can be used for shutting down the load and the UPS by thermal relay, for instance in the event of room over temperature. When RPO is activated, the UPS shuts down the output and all its power converters immediately. The UPS remains on to alarm the fault. The RPO circuit is an IEC 60950 safety extra low voltage (SELV) circuit. This circuit must be separated from any hazardous voltage circuits by reinforced insulation.

- The RPO must not be connected to any utility connected circuits. Reinforced insulation to the utility is required. The RPO switch must be a dedicated latching-type switch not tied into any other circuit. The RPO signal must remain active for at least 250 ms for proper operation.
- To ensure the UPS stops supplying power to the load during any mode of operation, the input power must be disconnected from the UPS when the Remote Power Off function is activated.

Leave the RPO connector installed in the RPO port on the UPS even if the RPO function is not needed.

RPO connections:

RPO	Comments
Connector type	Terminal, 14 AWG maximum wires
External breaker specification	60 V DC/30V AC 20mA max

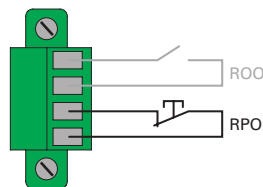
**Remote On/Off (ROO)**

- Remote On/Off allows remote action of button to switch On/Off the UPS.
- When contact changes from open to closed, the UPS is switched-on (or stays On).
- When contact changes from closed to open, the UPS is switched-off (or stays Off).
- On/Off control via button has priority over the remote control.

RPO	Comments
Connector type	Terminal, 14 AWG maximum wires
External breaker specification	60 V DC/30V AC 20mA max

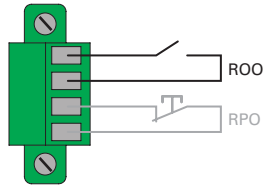

Remote Control Connection and Test

1. Check the UPS is shut down and the electrical supply network disconnected.
2. Remove RPO connector from the UPS by unfitting the screws.
3. Connect a normally closed volt-free contact between the two pins of connector.

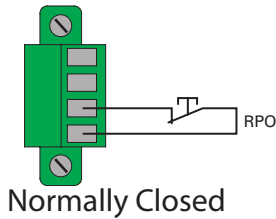

Contact open: shut down of UPS
 To return to normal operation, deactivate the external remote shut down contact and restart the UPS from the front panel.

4. Plug the RPO connector into the back of the UPS and fix the screws.
5. Connect and restart the UPS according to the previously described procedures.
6. Activate the external remote shut down contact to test the function. Always test the RPO function before applying your critical load to avoid accidental load loss.

Programmable Signal Outputs

The Tripp Lite by Eaton SmartOnlineUPS incorporates 4 programmable signal outputs: one relay output, three optocouplers outputs (pin- 1/7/8). Signal outputs can be configured (see COM SETTING->OUTPUT RELAY, OUTPUT DB9-1,OUTPUT DB9-7,OUTPUT DB9-8 to report the following information:

Signal	Default Assignment	Description
On battery (On bat)	DB9-Pin 8	UPS is in battery mode
Low battery (Low bat)	DB9-Pin 1	Battery is nearly empty
Battery fault (Bat fault)	-	Battery fault
Bypass	Relay output (1)	UPS is operating in Bypass mode
UPS OK	DB9-Pin 7	Load is powered (from inverter or bypass), with no alarm
Load powered	-	Load is powered (from inverter or bypass)
Load protected	-	UPS is on inverter, with no alarm and ready to go to battery
General alarm	-	Choose events that will trigger this alarm trough the LCD

Signal	Default Assignment	Description
BAT CHARGING	-	Control an optional external battery charger on and off.
OVL pre-alarm	-	Overload pre-alarm

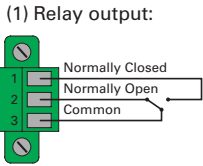

Connectivity Cards

Connectivity cards allow the UPS to communicate in a variety of networking environments and with different types of devices. The Tripp Lite by Eaton SmartOnlineUPS models have one available communication bay for the following connectivity cards:

- **Network card (WEBCARDLXE)** — Provides monitoring and control using an SNMP network management platform, web browser, SSH or Telnet.

Figure 16. WEBCARDLXE Connectivity Card

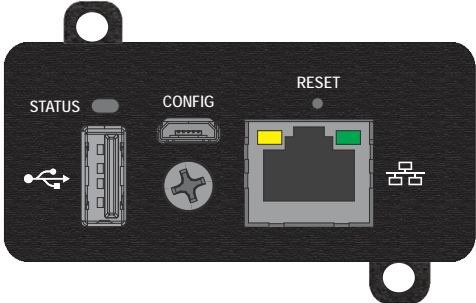

Installation of the communication card (optional)

NOTE Connect a Cat-6 shielded ethernet cable (F/UTP or F/FTP) or higher between the LX Platform device’s ethernet port and a network jack.

It is not necessary to shutdown the UPS before installing a communication card.

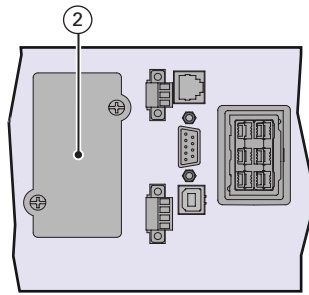

1. Remove the slot cover ② secured by screws.
2. Inset the communication card in the slot.
3. Secure the card with the 2 screws.

3.8 Tripp Lite By Eaton PowerAlert Software Suite

Tripp Lite by Eaton PowerAlert software suite is available from www.tripplite.com. The PowerAlert software suite provides up-to-date graphics of UPS power and system data and power flow. It also gives you a complete record of critical power events, and it notifies you of important UPS or power information. If there is a power outage and the SmartOnline UPS battery power becomes low, the PowerAlert Software suite can automatically shut down your computer system to protect your data before the UPS shutdown occurs.



3.9 Cybersecurity

Tripp Lite by Eaton is committed to minimizing the Cybersecurity risk in its products and deploys cybersecurity best practices and latest cybersecurity technologies in its products and solutions, making them more secure, reliable and competitive for our customers. Tripp Lite by Eaton also offers Cybersecurity Best Practices white papers to its customers, referenced at www.eaton.com/cybersecurity.

Chapter 4 Operation

4.1 Start-up and Normal operation

To start the UPS:

1. Verify that the internal batteries are connected. See [2.3 Connecting the Internal Battery](#).
2. If optional external battery packs are installed, verify that the external battery pack are connected to the UPS. See section [2.4 SmartOnline External Battery Pack Installation](#).
3. Verify that the UPS power cord is plugged in.
4. The UPS front panel display illuminates and displays the *UPS Home Menu* see [3.3 UPS Home Menu](#).
5. Press the  button on the UPS front panel for at least 2 seconds. The UPS display will read “UPS Starting” .
6. Check the UPS front panel display for active alarms or notices. If the  indicator is on, do not proceed until all alarms are cleared. Check the UPS status from the front panel to view the active alarms. Correct the alarms and restart if necessary. See [6.1 Typical Alarms and Faults](#) .
7. Verify that the  indicator illuminates solid, indicating that the UPS is operating normally and any loads are powered and protected. The UPS should be in normal mode.



4.2 Starting the UPS on Battery



NOTE



By default the “Cold Start or battery start setting is enabled from the factory.

To start the UPS on battery:

1. Press the  button on the UPS front panel until the UPS front panel display illuminates and shows a status of “UPS Starting...”. The UPS transfers from Standby mode to Battery mode. The  indicator illuminates solid. The UPS supplies power to your equipment.
2. Check the UPS front panel display for active alarms . Resolve any active alarms before continuing. See the [“6.1 Typical Alarms and Faults”](#) section .

4.3 UPS Shutdown

To shut down the UPS:

1. Press the  button on the front panel for three seconds. The UPS then transfers to Standby mode and the  indicator turns off. If utility power is removed from the input of the UPS while in the “Standby Mode” the system will then begin to shut down after 10 seconds.

4.4 Operating Modes

The Tripp Lite by Eaton SmartOnline UPS front panel indicates the status through the front panel indicators, see section .

Online Mode

During Online mode, the  indicator illuminates solid and the UPS is powered from the utility. The UPS monitors and charges the batteries as needed and provides filtered power protection to your equipment. Optional High Efficiency and Energy Saving settings minimize heat contribution to the rack environment.

Battery Mode

When the UPS is operating during a power outage, the  indicator illuminates solid. The necessary energy is provided by the battery. When the utility power returns, the UPS transfers to Online mode operation while the battery recharges. If battery capacity becomes low while on Battery mode, the audible alarm beeps once every 3 seconds. This warning is approximate, and the actual time to shutdown may vary significantly. Shutdown all applications on the connected equipment because automatic UPS shutdown is imminent. When utility power is restored after the UPS shuts down, the UPS automatically restarts.

Low-Battery Warning

- The  indicator illuminates solid.
- The audio alarm beeps every three seconds.

The remaining battery power is low. Shut down all applications on the connected equipment because automatic UPS shutdown is imminent.

End of battery backup time

- LCD displays "End of backup time".
- All the LEDs go OFF.
- The audio alarms stops.

Bypass Mode

In the event of a UPS overload or internal failure, the UPS transfers your equipment to utility power. Battery mode is not available and your equipment is not protected; however, the utility power continues to be passively filtered by the UPS. The  indicator illuminates. Depending on overload conditions, the UPS remains in Bypass mode for at least 5 seconds and will stay in this mode if three transfers to Bypass occur within 20 minutes.

The UPS transfers to Bypass mode when:

- the user activates Bypass mode through the front panel.
- the UPS detects an internal failure.
- the UPS has an overtemperature condition.
- the UPS has an overload condition listed in [7.1 Model Specifications](#).

The UPS shuts down after a specified delay for overload conditions listed in [7.1 Model Specifications](#). The UPS remains on to alarm the fault.

4.5 Return of AC Power

Following an outage, the UPS restarts automatically when AC input power returns (unless the restart function has been disabled) and the load is supplied again. See [3.5 User Settings](#) to verify the auto restart setting is enabled.

4.6 Setting High Efficiency mode

In High Efficiency mode, the UPS operates normally on Bypass and transfers to Online (or Battery) mode in less than 10 ms when utility fails. Transfers to High Efficiency mode will be active after 5 minutes of Bypass voltage monitoring: if Bypass quality is not in tolerance, then the UPS will remain in Online mode.

Eaton recommends to use the HE mode only to protect IT equipment.

To set the High Efficiency mode:

1. From the "UPS Home Menu" press the  button to enter into the "Main Menu Screen".

2. In the "Main Menu Screen" press the ▲ or ▼ button until the "IN / OUT SETTINGS" menu is displayed.
3. Press the ← button. Use the ▲ or ▼ arrow buttons to display "HIGH EFFIC. MODE".
4. Press the ← button and change the setting to "ENABLED".
5. The UPS transfers to High Efficiency mode after 5 minutes.

4.7 Configuring the Battery Settings

Automatic Battery Tests

Automatic battery tests are once a month in constant charging mode.

The tests frequency can be modified.

During the test, the UPS transfers to Battery mode and discharges the batteries for 10 seconds under load.

Low battery warning

During discharge, the low battery alarm is activated if the remaining runtime goes below 3 minutes or less than the setting capacity threshold (0 % by default). This threshold can be modified.

Restart battery level

This setting is used to define the battery restart level. The battery level must reach this threshold (0 % by default) to enable UPS start.

See the [3.5 User Settings](#) section to modify these settings.

4.8 Retrieving the Event Log

To retrieve the Event log through the display:

1. From the "[3.3 UPS Home Menu](#)" press the ← button to enter into the "[3.5 User Settings](#)" screen .
2. In the "[3.5 User Settings](#)" press the ▲ or ▼ button until the "Event Log" menu is displayed.
3. Press the ← button. Use the ▲ or ▼ arrow buttons to display the events.

The log retains 50 events with the most recent event listed as the first event. Press the ESC button twice to exit back to the "[3.3 UPS Home Menu](#)" menu.

Retrieving the Event Log

Chapter 5 UPS Maintenance

5.1 Equipment Care

For the best preventive maintenance, keep the area around the equipment clean and dust free. If the atmosphere is very dusty, clean the outside of the system with a vacuum cleaner. For full battery life, keep the equipment at an ambient temperature of 25 °C (77 °F).

If the UPS requires any type of transportation, verify that the UPS is disconnected and turned off. The batteries are rated for a 3-5 year service life. The length of service life varies, depending on the frequency of usage and ambient temperature (life divided by 2 each 10 °C above 25 °C).

Batteries used beyond expected service life will often have severely reduced runtimes. Replace batteries at least every 4 years to keep units running at peak efficiency. Batteries runtime will be reduced at low temperature (below 10 °C).

5.2 Storing the Equipment

If you store the equipment for a long period, recharge the battery every 6 months by connecting the UPS to utility power. The internal batteries charge to 90% capacity in less than 3 hours. However, Eaton recommends that the batteries charge for 24 hours after long-term storage. Check the battery recharge date on the shipping carton label. If the date has passed and the batteries were never recharged, do not use them. Contact your service representative.

5.3 When to Replace Batteries

Tripp Lite by Eaton UPS batteries have an expected life span of 3-5 years. You should take proactive steps to ensure you replace your batteries for optimal operation and reliability.

Contact your service representative to order new batteries.

5.4 Replacing batteries



IMPORTANT

DO NOT DISCONNECT the batteries while the UPS is in Battery mode.

Batteries can be replaced easily without turning off the UPS or disconnecting the load. If you prefer to remove input power to change the batteries, see "UPS Shutdown".

Consider all warnings, cautions, and notes before replacing batteries.

- Servicing should be performed by qualified service personnel knowledgeable of batteries and required precautions. Keep unauthorized personnel away from batteries.
- Batteries can present a risk of electrical shock or burn from high short circuit current. Observe the following precautions:
 1. Remove watches, rings, or other metal objects,
 2. Use tools with insulated handles,
 3. Do not lay tools or metal parts on top of batteries,
 4. Wear rubber gloves and boots.
- When replacing batteries, replace with the same type and number of batteries or battery packs. Contact your service representative to order new batteries.
- Proper disposal of batteries is required. Refer to your local codes for disposal requirements.
- Never dispose of batteries in a fire. Batteries may explode when exposed to flame.

Replacing batteries

- Do not open or mutilate the battery or batteries. Released electrolyte is harmful to the skin and eyes and may be extremely toxic.
- Determine if the battery is inadvertently grounded. If inadvertently grounded, remove source from ground. Contact with any part of a grounded battery can result in electrical shock. The likelihood of such shock can be reduced if such grounds are removed during installation and maintenance (applicable to equipment and remote battery supplies not having a grounded supply circuit).
- **ELECTRIC ENERGY HAZARD.** Do not attempt to alter any battery wiring or connectors. Attempting to alter wiring can cause injury.
- Disconnect charging source prior to connecting or disconnecting battery terminals.

Replacing the internal battery

The internal battery is heavy. Use caution when handling the heavy batteries.

Figure 17. Internal Battery Pack Replacement

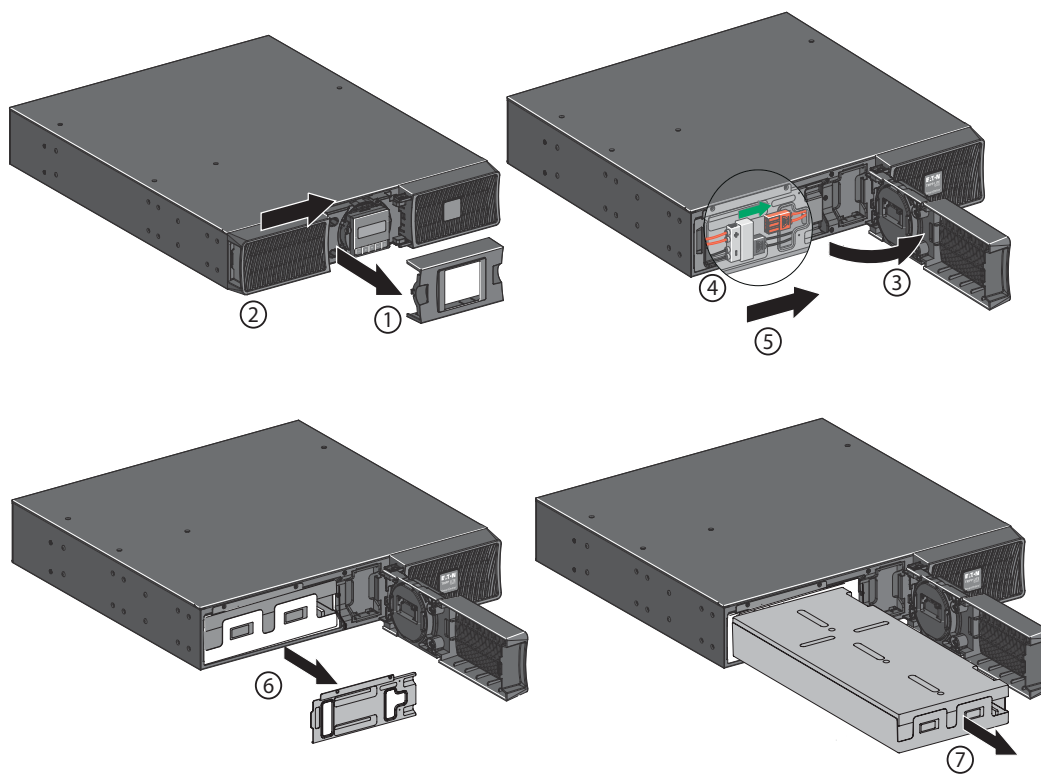

To replace the battery pack:

1. Remove the center cover of the front panel.
2. Push left cover toward to right direction.
3. Open the battery door.
4. Disconnect the battery connectors.

A ribbon cable connects the LCD control panel to the UPS. Do not pull on the cable or disconnect it.

5. Remove the two screws to pull out the metal protection cover of the battery.
6. Pull out the plastic handle of the battery pack, and slide the pack out slowly on to a flat and stable surface. Use two hands to support the battery pack. See [5.5 Recycling the used equipment](#) for proper disposal.
7. Verify that the replacement batteries have the same rating as the batteries being replaced.
8. Put the new battery pack into the UPS. Push the battery pack firmly, reconnect the red and black battery connectors.
9. Verify that all of the alarms have cleared on the display.
10. Screw back the metal protection cover and the front panel, then clip the center cover.

Replacing the extended battery pack(s)

The extended battery pack is heavy. Lifting the cabinet into a rack requires a minimum of two people.

To replace the extended battery pack(s):

1. Unplug the extended battery pack power cable and battery detection cable from the UPS. If additional extended battery pack(s) are installed, unplug the extended battery pack power cable and battery detection cable from each extended battery pack.
2. Replace the extended battery pack(s). See "[5.5 Recycling the used equipment](#)" for proper disposal.
A small amount of arcing may occur when connecting an extended battery pack to the UPS. This is normal and will not harm personnel. Insert the extended battery pack cable into the UPS battery connector quickly and firmly.
3. Plug the extended battery pack cable(s) into the battery connector(s). Up to four extended battery packs may be connected to the UPS.
4. Verify that the extended battery pack connections are tight and that adequate bend radius and strain relief exist for each cable.
5. Connect the battery detection cable(s) to the connector of the UPS and of the extended battery pack(s).

Testing new batteries

To test new batteries:

1. Press any button to activate the menu options.
2. Select Control then Start battery test.

The UPS starts a battery test if the batteries are fully charged, the UPS is in Normal mode with no active alarms, and the bypass voltage is acceptable.

During the battery test, the UPS transfers to Battery mode and discharges the batteries for 25 seconds. The front panel displays "Battery test in progress" and the percentage of the test completed.



NOTE

The UPS load percentage must be greater than 10% in order to run a battery test.

5.5 Recycling the used equipment

Contact your local recycling or hazardous waste center for information on proper disposal of the used equipment.



RISK OF ELECTRIC SHOCK - Observe the warning associated with the risk of electric shock symbol.



This symbol indicates that you should not discard the UPS or the UPS batteries in the trash. This product contains sealed lead acid batteries and must be disposed of properly. For more information, contact your local recycling/reuse or hazardous waste center.



This symbol indicates that waste electrical and electronic equipment as well as waste batteries and accumulators should not be discarded together with unseparated household waste, but must be collected separately. The product should be handed in for recycling in accordance with the local environmental regulations for waste disposal. By separating waste electrical and electronic equipment as well as waste batteries and accumulators, you will help reduce the volume of waste sent for incineration or land-fills and minimize any potential negative impact on human health and environment.

Chapter 6 Troubleshooting

6.1 Typical Alarms and Faults

The SmartOnline series UPS units are designed for durable, automatic operation and also alert you whenever potential operating problems may occur. Usually the alarms shown by the control panel do not mean that the output power is affected. Instead, they are preventive alarms intended to alert the user.

- Events are silent status information that are recorded into the Event log. Example = "AC freq in range".
- Alarms are recorded into the Event log and displayed on the LCD status screen with the logo blinking. Some alarms may be announced by a beep every 3 seconds. Example = "Battery low".
- Faults are announced by a continuous beep and red LED, recorded into the Fault log and displayed on the LCD with a specific message box. Example = Out. short circuit.

Use the following troubleshooting chart to determine the UPS alarm condition.

Checking the Alarms and Faults

The following table describes typical conditions. See [Table 9](#) and [Table 10](#) for more detailed fault and alarm codes.

Table 8. Typical UPS Conditions





Conditions	Possible cause	Action
Battery mode  LED is On. 1 beep every 10 seconds	A utility failure has occurred and the UPS is in battery mode.	The UPS is powering the equipment with battery power. Prepare your equipment for shutdown.
Battery mode  LED is On. 1 beep every 3 seconds	The UPS is in Battery mode and the battery is running low.	This warning is approximate, and the actual time to shutdown may vary significantly. Depending on the UPS load and number of Extended Battery Modules (EBMs), the "Battery Low" warning may occur before the batteries reach 0% capacity.
No battery  LED is On Beep continuous	The batteries are disconnected.	Verify that all batteries are properly connected. To clear a battery disconnected alarm a battery test must be initiated. If the condition persists, contact your service representative.
Battery fault  LED is On Beep continuous	The battery test is failed due to bad or disconnected batteries.	Verify that all batteries are properly connected. If the condition persists, contact your service representative. To clear a battery disconnected alarm a battery test must be initiated. If the condition persists, contact your service representative.
The UPS does not provide the expected backup time.	The batteries need charging or service.	Apply utility power for 48 hours to charge the batteries. If the condition persists, contact your service representative.

Table 8. Typical UPS Conditions (Continued)



Conditions	Possible cause	Action
Bypass mode  LED is on.	An overload or a fault has occurred, or a command has been received and the UPS is in Bypass	Equipment is powered but not protected by the UPS. Check for one of the following alarms: overtemperature, overload or UPS LED is on. failure.
Power Overload  LED is on. 1 beep every 3 seconds	Power requirements exceed the UPS capacity (greater than 100% of nominal; see "User Settings" for specific output overload ranges).	Remove some of the equipment from the UPS. The UPS continues to operate, but may switch to Bypass mode or shut down if the load increases. The alarm resets when the condition becomes inactive.
UPS Overtemperature  LED is on. 1 beep every 3 seconds	The UPS internal temperature is too high or a fan has failed. At the warning level, the UPS generates the alarm but remains in the current operating state. If the temperature rises another 10°C, the UPS transfers to Bypass mode or shuts down if Bypass is unusable.	If the UPS transferred to Bypass mode, the UPS will return to normal operation when the temperature drops 5°C below the warning level. If the condition persists, shut down the UPS. Clear vents and remove any heat sources. Allow the UPS to cool. Ensure the airflow around the UPS is not restricted. Restart the UPS. If the condition continues to persist, contact your service representative.
The UPS does not start	The input source is not connected correctly.	Check the input connections.
	The Remote Power Off (RPO) switch is active or the RPO connector is missing.	If the UPS Status menu displays the "Remote Power Off" notice, inactivate the RPO input.

Table 9. UPS Fault Codes

Fault Code	Displayed Alarm	Potential Cause
007	FAN FAULT	Fan don't work normally or Fan detection circuit is abnormal
107	INPUT BAD WIRING	Refer to Site Wiring Fault
207	BP DEVICE FAULT	Bypass relay is stuck or driver circuit is abnormal
208	BP OVERLOAD	Bypass overload fault! > 125% (max counter reached)
300	DC BUS+ TOO HIGH	Overload/improper load type/ input high pulse /PSDR damaged /CNTL damaged
301	DC BUS- TOO HIGH	Overload/improper load type/ input high pulse /PSDR damaged /CNTL damaged
302	DC BUS+ TOO LOW	Overload/improper load type/PSDR/CNTL damaged
303	DC BUS- TOO LOW	Overload/improper load type/PSDR/CNTL damaged
304	DC BUS UNBALANCE	Overload/improper load type/PSDR/CNTL damaged

Table 9. UPS Fault Codes (Continued)

Fault Code	Displayed Alarm	Potential Cause
305	RECT FAULT	Hardware fault in the rectifier /PFC
308	DC BUS SHORTED	Dc bus short circuit
400	DCDC FAULT	Hardware fault in the DCDC part
500	CHARGER FAULT	Charger internal failure
502	MAX CHARGER VOLT	Recharge battery voltage is too high
503	MIN CHARGER VOLT	If battery voltage has not reached UchargeEnd within tchargeMax then go to Float mode.
		In that case if battery voltage is < 2.25 VPC then "Charger fault" alarm is set.
		tchargeMax = 24h x Number of EBM
607	BATTERY FAULT	Battery need replacement OR is faulty
700	CURRENT LIMIT	Current limitation (due to limitation, UPS has transferred to bypass or stop)
706	UPS TEMP. FAULT	UPS internal temperature is high (due to temperature, UPS has transferred to bypass or stop)
70C	MIN INV VOLT	Inverter voltage is too low
70D	MAX INV VOLT	Inverter voltage is too high
805	OUTPUT SHORTED	short circuit on output
808	INV OVERLOAD	Inverter overload
		Max (P,S) > L2 (L2 = 102%) max counter reached
C39	NVM NO RESPONSE	EEPROM can't read/write normally
815	CALIBRATION FLT	DC offset of INV voltage is too high
00F	MODEL ERROR	ATE set country error(stored in COM board EEPROM).

Table 10. UPS Alarm Codes

Alarm Code	Displayed Alarm	Potential Cause	Action
001	AC LOSS	Main AC is below charger level	Check AC mains
004	AMB. TEMP. ALARM	Ambient temperature is high	Please check ambient temperature and if the ventilation is blocked
104	AC FREQ NOT OK	Frequency out of range	Check AC Freq
106	AC VOLT NOT OK	Voltage out of range	Check AC Volt

Table 10. UPS Alarm Codes (Continued)

Alarm Code	Displayed Alarm	Potential Cause	Action
110	BUILDING ALARM	building alarm by input signal contactor	
200	BP PHASE NOT OK	Phase out of range (bypass input and inverter output cannot phase lock)	Check Bypass AC frequency
206	BP FREQ. NOT OK	Frequency out of range	Check Bypass AC frequency
208	BP OVERLOAD	Bypass overload alarm	Check and reduce load
209	BP VOLT NOT OK	Input Voltage out of bypass range	Please check input voltage
603	BATTERY MODE	Battery is discharging	Please check input voltage
604	BATTERY LOW	Battery level is below RemainingCapacityLimit threshold or RunTimeToEmpty is below RemainingTimeLimit threshold.	Please check the mains and Prepare to shut off load
60D	NO BATTERY	Battery not present	Please check if batteries are connected rightly or fuse is open
612	BAT TEST ABORTED	Battery test condition is not met.	Check: UPS mode is AC (online) or HE;
			Load must be greater than 10%;
			Battery capacity should be $\geq 80\%$;
			There is no running alarm (excepted Battery fault);
			Load level has not varied by more than +/- 10 percent (from the initial load level present at the beginning of the test to the beginning of step2 test).
700	CURRENT LIMIT	inverter current limitation	Check load
706	UPS TEMP. ALARM	UPS internal temperature is high	Please check ambient temperature and if the ventilation is blocked, and if fan works normal.
802	IMMINENT SHUTOFF	shut down imminent for battery low	Please prepare for shutdown
806	EMERGENCY OFF	emergency stop was proceed	Please check if RPO is active
80E	OVLD PREALARM	output power above threshold 102%(default), settable from HMI.	Check overload pre-alarm setting and load
810	POWER OVERLOAD	Output power overload, Max (P,S) > L2 (L2 = 102%)	Please check the load capacity

6.2 Silencing the Alarm

Press the ESC (Escape) button on the front panel display to silence the alarm. Check the alarm condition and perform the applicable action to resolve the condition. If the alarm status changes, the alarm beeps again, overriding the previous alarm silencing.

6.3 Service and Support

If you have any questions or problems with the UPS, call the Eaton technical support helpdesk at 800-356-5737 or your local service representative and ask for a UPS technical representative. Please have the following information ready when you call for service:

- Model number
- Serial number
- Firmware version number
- Date of failure or problem
- Symptoms of failure or problem
- Customer return address and contact information

If repair is required, you will be given a Returned Material Authorization (RMA) number. This number must appear on the outside of the package and on the Bill Of Lading (if applicable). Use the original packaging or request packaging from the Help Desk or distributor. Units damaged in shipment as a result of improper packaging are not covered under warranty. A replacement or repair unit will be shipped, freight prepaid for all warrantied units.

Chapter 7 Specifications

7.1 Model Specifications

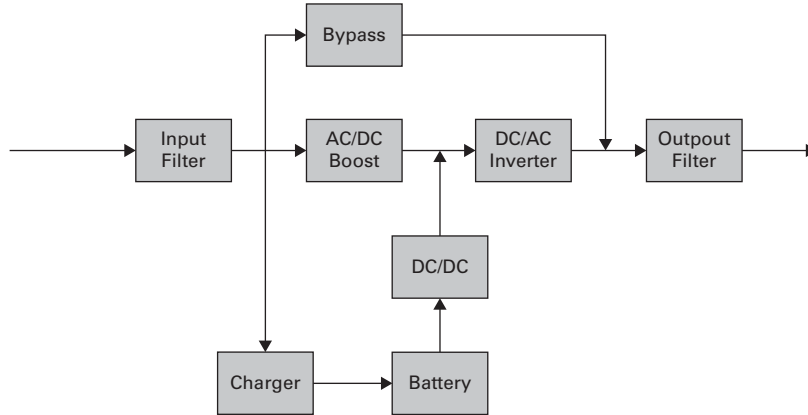

Table 11. Power Module List

Catalog Number (UPS)	Power ratings
SU750RTXLCD2U / SU750RTXLCD2UN	750VA / 675W
SU1000RTXLCD2U / SU1000RTXLCD2UN	1000VA / 900W
SU1500RTXLCD2U / SU1500RTXLCDN	1500VA / 1350W
SU2200RTXLCD2U / SU2200RTXLCDN	2000VA / 1800W
SU3000RTXLCD2U / SU3000RTXLCD2UN	3000VA / 2700W
SUJINT1000LCD2U	1000VA / 900W
SUJINT1500LCD2U	1500VA / 1350W
SUJINT2200LCD2U	2200VA / 2000W
SUJINT3000LCD2U	3000VA / 2700W

Table 12. Extended Battery Module List

Catalog Number (UPS)	Configuration	Battery Voltage	For Power Module
BP36RT	Rack / Tower	36Vdc	750 – 1000VA LV Models
BP48RT	Rack / Tower	48Vdc	1500VA LV Model 1000 – 1500VA SUJINT Models
BP72RT	Rack / Tower	72Vdc	2000 – 3000VA LV Models 2200– 3000VA SUJINT Models

Table 13. Weights and Dimensions

Model	Weight (lb / kg)	Dimensions D x W x H(inch/mm)
SU750RTXLCD2U / SU750RTXLCD2UN	36.4 / 16.5	17.7 x 17.3 x 3.4 / 450 x 440 x 86.5
SU1000RTXLCD2U / SU1000RTXLCD2UN	36.4 / 16.5	17.7 x 17.3 x 3.4 / 450 x 440 x 86.5
SU1500RTXLCD2U / SU1500RTXLCDN	42.5 / 19.3	17.7 x 17.3 x 3.4 / 450 x 440 x 86.5
SU2200RTXLCD2U / SU2200RTXLCDN	61.6 / 27.9	23.8 x 17.3 x 3.4 / 605 x 440 x 86.5
SU3000RTXLCD2U / SU3000RTXLCD2UN	63 / 28.6	23.8 x 17.3 x 3.4 / 605 x 440 x 86.5
SUINT1000LCD2U	36.4 / 16.5	17.7 x 17.3 x 3.4 / 450 x 440 x 86.5
SUINT1500LCD2U	41.4 / 18.8	17.7 x 17.3 x 3.4 / 450 x 440 x 86.5
SUINT2200LCD2U	59.7 / 27.1	23.8 x 17.3 x 3.4 / 605 x 440 x 86.5
SUINT3000LCD2U	61.2 / 27.8	23.8 x 17.3 x 3.4 / 605 x 440 x 86.5
BP36RT	48.1 / 21.8	17.7 x 17.3 x 3.4 / 450 x 440 x 86.5
BP48RT	59.5 / 27	17.7 x 17.3 x 3.4 / 450 x 440 x 86.5
BP72RT	86.4 / 39.2	23.8 x 17.3 x 3.4 / 605 x 440 x 86.5

Table 14. Electrical Input

Catalog Number (UPS)	Default Input (Voltage/Max Current)	Input Nominal Voltages	Input Voltage Window at Rated Load
SU750RTXLCD2U / SU750RTXLCD2UN	120V / 6.2A	100V, 110V, 120V, 125V	100–138V
SU1000RTXLCD2U / SU1000RTXLCD2UN	120V / 8.3A		
SU1500RTXLCD2U / SU1500RTXLCDN	120V / 12.5A		
SU2200RTXLCD2U / SU2200RTXLCDN	120V / 16A		
SU3000RTXLCD2U / SU3000RTXLCD2UN	120V / 24A		
SUINT1000LCD2U	208V / 4.8A	200V, 208V, 220V, 230V, 240V	176–276V
SUINT1500LCD2U	208V / 7.2A		
SUINT2200LCD2U	208V / 10.57A		
SUINT3000LCD2U	208V / 14.42A		
Nominal Frequency		50/60Hz auto-sensing	
Frequency Range		40-70Hz before transfer to battery	
Bypass Voltage Range		-20% / +15% of nominal value (default)	
Noise Filtering		Not Available for US Models	

Table 15. Electrical Input Connections

Catalog Number (UPS)	Input Connection	Input cable
SU750RTLCD2U / SU750RTLCD2UN	5–15P	Attached line cord 8ft / 2.4m
SU1000RTLCD2U / SU1000RTLCD2UN		
SU1500RTLCD2U / SU1500RTLCDN		
SU2200RTLCD2U / SU2200RTLCDN	5–20P	Attached line cord 8ft / 2.4m
SU3000RTLCD2U / SU3000RTLCD2UN	L5–30P	Attached line cord 8ft / 2.4m
SUINT1000LCD2U	IEC-C14	6ft / 1.8m
SUINT1500LCD2U		
SUINT2200LCD2U	IEC-C20 L6-20P to C19 jumper provided	6ft / 1.8m
SUINT3000LCD2U		

Table 16. Electrical Output

All Models	Normal Mode	Efficiency Mode	Battery Mode
Voltage Regulation	±1%		±2%
Efficiency	89.9% for 750 LV models 90.3% for 1.K LV models 90.2% for 1K SUI NT models 90% for 1.5K LV models 91% for 1.5K SUI NT models 91.4% for 2K LV models 93% for 2K SUI NT models 94% for 3K SUI NT models	95.3% for 750 LV models 95.8% for 1K LV models 96% for 1K SUI NT models 95.8% for 1.5K LV models 96.5% for 1.5K SUI NT models 96.8% for 2K LV models 98% for 2K SUI NT models 97.2% for 3K LV models 98% for 3K SUI NT models	83% for 750 LV models 83% for 1K LV models 87.5% for 1K SUI NT models 84% for 1.5K LV models 87.5% for 1.5K SUI NTmodels 86% for 2K LV models 90% for 2K SUI NT models 86% for 3K LV models 89% for 3K SUI NT models
Frequency Regulation	Sync with line ±5% of nominal line frequency (outside this range: ±0.5% of auto-selected nominal frequency)		±0.5% of auto-selected nominal frequency
Nominal Output	[100V] [110V] [120V] [125V] (LV models) [200V] [208V] [220V] [230V] [240V] (SUI NT models)		
Frequency	50 or 60 Hz, autosensing follows the input frequency		
Output Overload	Online mode: 102%~130% :12s 130%~150% :2s >150% :shutdown after 300ms Percent is based on nominal Watt/VA. Transfer behavior can change (see output mode setting on page 14) Battery mode: 102%~130% :12s >130% :2s Overload warning then transfer to stop output		
Output Overload (Bypass Mode)	102%~110% :Overload warning 110%~130% :shutdown after 5mins 130%~150% :shutdown after 15s		

Table 16. Electrical Output (Continued)

All Models	Normal Mode	Efficiency Mode	Battery Mode
	>150% :shutdown after 300ms Percent is based on nominal current in bypass mode		
Voltage Waveform	Sinewave		
Harmonic Distortion	< 3% THDV on linear load < 5% THDV on non-linear load		
Transfer Time	Online Mode: 0ms High Efficiency mode: 10ms maximum (due to loss of utility)		
Power Factor	Up to 0.9		
Load Crest Ratio	Up to 3:1		

Table 17. Electrical Output Connections

Model	Output Connection	Output Cable
SU750RTXLCD2U / SU750RTXLCD2UN	(4) 5–15R Primary (2) 5–15R Group 1 (2) 5–15R Group 2	No
SU1000RTXLCD2U / SU1000RTXLCD2UN		
SU1500RTXLCD2U / SU1500RTXLCDN		
SU2200RTXLCD2U / SU2200RTXLCDN	5-20R(2) + L5-20R(1) Primary 5-20R(2) Group1 5-20R(2) Group2	No
SU3000RTXLCD2U / SU3000RTXLCD2UN	5-20R(2) + L5-30R(1) Primary 5-20R(2) Group1 5-20R(2) Group2	No
SUINT1000LCD2U	(4) IEC320 10A Primary (2) IEC320 10A Group 1 (2) IEC320 10A Group 2	No
SUINT1500LCD2U		
SUINT2200LCD2U	(4) IEC320 10A + (1) IEC320 16A Primary (2) IEC320 10A + (1) IEC320 16A Group 1 (2) IEC320 10A Group 2	(2) IEC320 10A
SUINT3000LCD2U		

Table 18. Environmental and Safety

Certifications	IEC/EN 62040-1 IEC/EN 62040-2 : Cat. C2 IEC/EN 62040-3 UL1778 5th edition CSA 22.2
EMC	EN IEC 62040–2: C2 FCC part 15 Class A/ ICES-003 (A)
Agency Markings	cTUVus/NOM(TUV NOM)/CE (SU750RTXL- SU1500RTXLCD Models)

Table 18. Environmental and Safety (Continued)

	cTUVus/NOM(TUV NOM)/Energy-star/CE (SU2200RTXL — SU3000RTXL Models) cTUVus/Energy-star/CE/UKCA (SUIINT1000LCD - SUIINT3000LCD Models) CE/cTUVus- (BP36RT — BP72RT Models)
Operating Temperatures	0 to 40 °C (32 to 104 °F) in Online mode, with linear derating for altitude Note: thermal protection switches load to Bypass in case of overheating.
Protective class I	
Output short-circuit current max RMS & delay time	68A/7 cycles; The max peak value: 92A
This UPS can be used in and supplied to load TN/TT/IT power system for HV models, TN power system for LV models.	
UPS enclosure IP rating	IP20
Storage Temperatures	0 to 40°C (32 to 104°F) with batteries -25 to 55°C (-13 to 130°F) without batteries
Transit Temperature	-25 to 55°C (-13 to 130°F)
Relative Humidity	0 to 96% no condensing
Operating Altitude	Up to 3,000 meters (9,843 ft) above sea level, no derating for 35°C (95°F) room temperature
Transit Altitude	Up to 10,000 meters (32,808 ft) above sea level
Audible Noise	< 50 dBA at 1 meter typical

Table 19. Battery

	Internal Batteries	EBM
Rack / Tower configuration	750VA: 36Vdc 1000VA LV: 36Vdc 1000VA INT: 48Vdc 1500VA: 48Vdc 2200VA: 72Vdc 3000VA: 72Vdc	BP36RT: 36Vdc- 2 x 3 x 12V. 9Ah BP48RT: 48Vdc- 2 x 4 x 12V. 9Ah BP72RT: 72Vdc- 2 x 6 x 12V. 9Ah
Type	Sealed, maintenance-free, valve-regulated, lead-acid, with minimum 3-year float service life at 25 °C (77 °F). Lifetime is reduced above 25°C (77°F)	
EBM Battery Cable Length	350 mm / 13.78 in	



614-21325 03