

# Owner's Manual

## 5-Port Unmanaged Industrial Fast 10/100 Ethernet Switch with EIP QoS, DIN or Wall-Mountable

Model: NFI-U05A

Este manual está disponible en español en la página de Tripp Lite:  
[triplite.com](http://triplite.com)

Ce manuel est disponible en français sur le site Web de Tripp Lite :  
[triplite.com](http://triplite.com)

Русскоязычная версия настоящего руководства представлена на  
веб-сайте компании Tripp Lite по адресу: [triplite.com](http://triplite.com)

Dieses Handbuch ist in deutscher Sprache auf der Tripp Lite-Website  
verfügbar: [triplite.com](http://triplite.com)

### WARRANTY REGISTRATION

Register your product today and be  
automatically entered to win an ISOBAR®  
surge protector in our monthly drawing!

[triplite.com/warranty](http://triplite.com/warranty)



1111 W. 35th Street, Chicago, IL 60609 USA • [triplite.com/support](http://triplite.com/support)

Copyright © 2023 Tripp Lite. All rights reserved.

## Package Contents

- NFI-U05A Ethernet Switch
- DIN Rail-Mounting Clip (Preinstalled)
- Wall-Mount Mask (Preinstalled)
- Owner's Manual

## Product Features

- 5 auto-negotiable 10/100 Mbps RJ45 ports
- Supports 10/100Base-T, Full Duplex and auto MDI/MDI-X crossover function
- Rugged high-strength case
- Industrial temperature switch models support operating temperature range of -40°F to 167°F (-40°C to 75°C)
- Easy-to-read LEDs indicate connection and activity status for each port
- Meets the following IEEE standards:
  - o IEEE 802.3 10Base-T
  - o IEEE 802.3u 100Base-T
  - o IEEE 802.3 Auto Negotiation
  - o IEEE 802.3x Flow Control
  - o IEEE 802.1p Class of Service
- Supports MAC address auto-learning and auto-aging
- Preinstalled durable rail clip mounts firmly to any standard 35 mm DIN rail

## Optional Accessories

- N001-Series Cat5e 350 MHz Snagless UTP Cables
- N002-Series Cat5e 350 MHz UTP Ethernet Cables
- N200-Series Cat6 Gigabit Molded UTP Ethernet Cables
- N201-Series Cat6 Gigabit Snagless Molded UTP Ethernet Cables

## Product Overview

5-Port Unmanaged Industrial Fast 10/100 Ethernet Switch with EIP QoS, DIN or Wall-Mountable

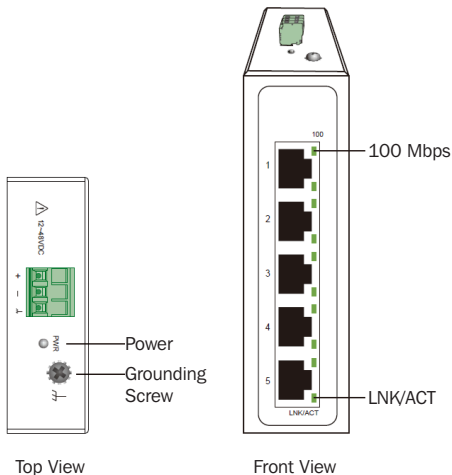

## DIN-Rail Mounting and Dismounting Instructions



**ATTENTION:** The NFI-U05A is an open-type device and shall be DIN-rail mounted or wall mounted (optional) in a cabinet or rack enclosure. The ambient temperature should not exceed 75°C (167°F).

### Mounting the Switch

Place the switch on the DIN rail from above using the built-in slot. Push the front of the switch toward the mounting surface until it snaps into place. You will hear a “click” to indicate it has successfully snapped into place.

## DIN-Rail Mounting and Dismounting Instructions

### Dismounting the Switch

Press the switch from the top, then pull out the lower edge of the switch to remove it from the DIN rail.

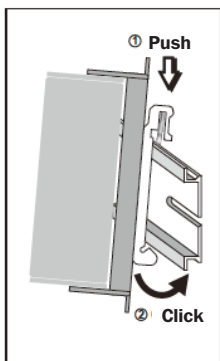

Mounting the Switch

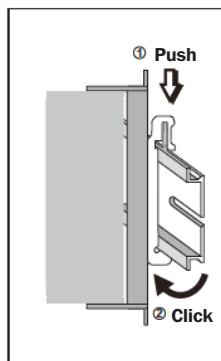

Removing the Switch

## DIN-Rail Mounting and Dismounting Instructions



**ATTENTION:** A corrosion-free DIN mounting rail is advisable. When mounting the switch, be sure to allow enough space between devices to install the cabling and to ensure proper airflow.

### Wall-Mounting Installation

1. Mount the switch by using mounting holes on the wall at the appropriate places.

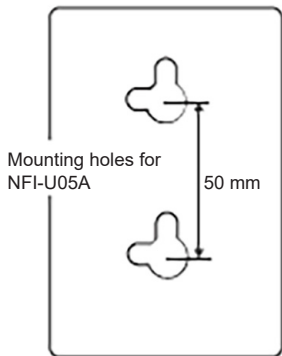

Mounting Holes for Drawing  
of NFI-U05A

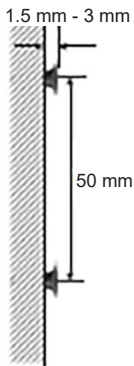

Screw Installation Distance

## DIN-Rail Mounting and Dismounting Instructions

- The switch can be wall mounted either vertically or horizontally.

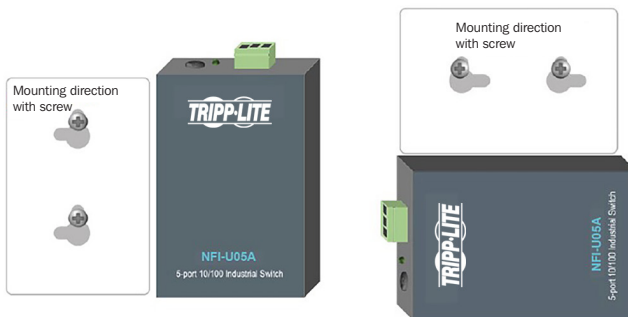

Straight Direction Installation

Horizontal Direction Installation

### Grounding the Switch

Grounding and wire routing help limit the effects of line noise caused by electromagnetic interference (EMI). Run the ground connection from the ground screw to the grounding surface, then connect the ground connection from the terminal block to the grounding surface prior to connecting devices.

**ATTENTION:** This switch is intended for mounting on a well-grounded surface, such as a metal panel.

## Wiring Requirements



**WARNING:** Safety measures should be taken before connecting the power cable. Turn off the power before connecting modules or wires. The correct power supply voltage is listed on the product label. Check the voltage of your power source to make sure you are using the correct voltage. DO NOT use a voltage greater than what is specified on the product label. Calculate the maximum possible current in each power wire and common wire. Confirm all electrical codes dictating the maximum current allowable for each wire size. If current exceeds the maximum rating, the wiring can overheat causing serious damage to your equipment.

### **Please read and follow these guidelines:**

- Use separate paths to route wiring for power and devices. If power wiring and device wiring paths must cross, make sure the wires are perpendicular at the intersection point.

**Note:** *Do not run signal or communications wiring and power wiring through the same wire conduit. To avoid interference, wires with different signal characteristics should be routed separately.*

- You can use the type of signal transmitted through a wire to determine which wires should be kept separate. Wiring that shares similar electrical characteristics can be bundled together.
- You should separate input wiring from output wiring.



## Wiring Requirements

- Be advised that you should label the wiring to all devices in the system.

### Wiring Power Input

#### NFI-U05A with 3-Pin Terminal Block

Check the polarity while connecting. Top view of the Terminal Block is shown in the figure below:

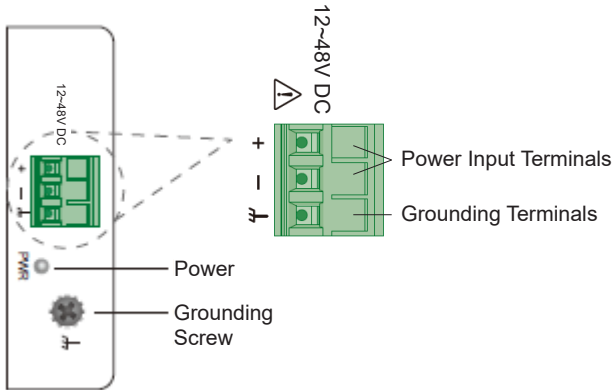

## Wiring Requirements

### CAUTION:

- Use copper conductors only.
- Wiring cable temperature should support at least 105°C (221°F).
- The wire gauge for the terminal block should range between 12~24 AWG.

To insert the power wire and connect the 12~48V DC at a maximum of 0.2A DC power to the power terminal block, follow the steps below:

- Use a flathead screwdriver to loosen the wire-clamp screws.
- Insert the negative/positive DC wires into the ( - / + ) terminals, respectively.
- Tighten the wire-clamp screws to prevent the wires from loosening.

**ATTENTION:** Use a power supply from 12~48V DC. The device power shall be supplied by an LPS circuit.

## Cabling

Connect one end of an RJ45 Ethernet cable (see **Optional Accessories**) into the switch's RJ45 Ethernet port. Connect the other end to a network device. Cat5e cable or above is recommended.

- Ports 1-5 of the switch support Fast Ethernet (10/100Base-T RJ45 Ports).
- All ports support Fast Ethernet (10/100Base-T), as well as auto-negotiation and auto MDI/MDI-X to eliminate the need for crossover cabling.

## LED Indicators

PWR (Green)	Illuminated	Power on
	Off	Power off
100 (Green)	Illuminated	Link speed is 100 Mbps
	Off	Link speed is 10 Mbps or link failed
LNK/ACT (Green)	Illuminated	Ethernet link-up
	Blinking	Activity (receiving or transmitting data)
	Off	Port disconnected or link failed

## Specifications

<b>Power</b>	
Input Voltage	Single power input 12~48VDC/0.2A
Connection	3-pin terminal block
Reverse Polarity Protection	Present
Power Consumption (System Only)	3W
Grounding Screw	Present
<b>Interface</b>	
RJ45	5 x 10/100Base-T, auto-negotiation, auto-MDI/MDI-X, Full/Half Duplex and Flow Control
LED	PWR (Green): Power 100 (Green): Port 1~5 Ethernet speed at 100 Mbps LNK/ACT (Green): Port 1~5 transmitting/receiving
<b>Environmental</b>	
Operating Temperature	-40°C to 75°C (-40°F to 167°F)
Storage Temperature	-40°C to 85°C (-40°F to 185°F)
Operating Humidity	5 to 95% (Non-Condensing)
Storage Humidity	5 to 95% (Non-Condensing)
Operating Altitude	2000 m

## Specifications

Regulatory Approvals	
EMI/EMC	FCC Part 15 EN 55011 / BS EN 55011 EN 61000-6-4 / BS EN 61000-6-4 EN IEC 61000-6-2 / BS EN 61000-6-2 EN 55032 / BS EN 55032 EN 55035 / BS EN 55035

**ATTENTION:** If the switch is used in a manner not specified here, the protection provided by the switch may be impaired.

# Warranty and Product Registration

## 3-Year Limited Warranty

Seller warrants this product, if used in accordance with all applicable instructions, to be free from original defects in material and workmanship for a period of three (3) years from the date of initial purchase. If the product should prove defective in material or workmanship within that period, Seller will repair or replace the product, at its sole discretion.

THIS WARRANTY DOES NOT APPLY TO NORMAL WEAR OR TO DAMAGE RESULTING FROM ACCIDENT, MISUSE, ABUSE OR NEGLIGENCE. SELLER MAKES NO EXPRESS WARRANTIES OTHER THAN THE WARRANTY EXPRESSLY SET FORTH HEREIN. EXCEPT TO THE EXTENT PROHIBITED BY APPLICABLE LAW, ALL IMPLIED WARRANTIES, INCLUDING ALL WARRANTIES OF MERCHANTABILITY OR FITNESS, ARE LIMITED IN DURATION TO THE WARRANTY PERIOD SET FORTH ABOVE; AND THIS WARRANTY EXPRESSLY EXCLUDES ALL INCIDENTAL AND CONSEQUENTIAL DAMAGES. (Some states do not allow limitations on how long an implied warranty lasts, and some states do not allow the exclusion or limitation of incidental or consequential damages, so the above limitations or exclusions may not apply to you. This warranty gives you specific legal rights, and you may have other rights which vary from jurisdiction to jurisdiction.)

WARNING: The individual user should take care to determine prior to use whether this device is suitable, adequate or safe for the use intended. Since individual applications are subject to great variation, the manufacturer makes no representation or warranty as to the suitability or fitness of these devices for any specific application.

## Product Registration

Visit [triplite.com/warranty](http://triplite.com/warranty) today to register your new Tripp Lite product. You'll be automatically entered into a drawing for a chance to win a FREE Tripp Lite product!\*

\*No purchase necessary. Void where prohibited. Some restrictions apply. See website for details.

# Warranty and Product Registration

## WEEE Compliance Information for Tripp Lite Customers and Recyclers (European Union)



Under the Waste Electrical and Electronic Equipment (WEEE) Directive and implementing regulations, when customers buy new electrical and electronic equipment from Tripp Lite, they are entitled to:

- Send old equipment for recycling on a one-for-one, like-for-like basis (this varies depending on the country)
- Send the new equipment back for recycling when this ultimately becomes waste

## FCC Notice, Class B

This device complies with part 15 of the FCC Rules. Operation is subject to the following two conditions: (1) This device may not cause harmful interference, and (2) this device must accept any interference received, including interference that may cause undesired operation.

Note: This equipment has been tested and found to comply with the limits for a Class B digital device, pursuant to part 15 of the FCC Rules. These limits are designed to provide reasonable protection against harmful interference in a residential installation. This equipment generates, uses and can radiate radio frequency energy and, if not installed and used in accordance with the instructions, may cause harmful interference to radio communications. However, there is no guarantee that interference will not occur in a particular installation. If this equipment does cause harmful interference to radio or television reception, which can be determined by turning the equipment off and on, the user is encouraged to try to correct the interference by one or more of the following measures:

- Reorient or relocate the receiving antenna.
- Increase the separation between the equipment and receiver.
- Connect the equipment into an outlet on a circuit different from that to which the receiver is connected.
- Consult the dealer or an experienced radio/TV technician for help.

Any changes or modifications to this equipment not expressly approved by Tripp Lite could void the user's authority to operate this equipment.

## Warranty and Product Registration

Use of this equipment in life support applications where failure of this equipment can reasonably be expected to cause the failure of the life support equipment or to significantly affect its safety or effectiveness is not recommended.

Tripp Lite has a policy of continuous improvement. Specifications are subject to change without notice. Photos and illustrations may differ slightly from actual products.



1111 W. 35th Street, Chicago, IL 60609 USA • [tripplite.com/support](http://tripplite.com/support)