

**NetDirector® 16-Port Cat5 KVM
over IP Switch**

Model:
B064C-16-1-IP



Purchased product
may differ from image.

Este manual está disponible en español en la página de Eaton:
Tripplite.Eaton.com/support

Ce manuel est disponible en français sur le site Web de Eaton :
Tripplite.Eaton.com/support

Dieses Handbuch ist in deutscher Sprache auf der Eaton-Website verfügbar:
Tripplite.Eaton.com/support

Questo manuale è disponibile in italiano sul sito web di Eaton:
Tripplite.Eaton.com/support



PRODUCT REGISTRATION

Register your product today for a
chance to win an ISOBAR® surge
protector in our monthly drawing!

Tripplite.Eaton.com/warranty



Table of Contents

1. FCC Information	4	7. Administration	30
2. User Notice	4	7.1 IP Address Determination	30
3. Package Contents	4	7.1.1 IPv6	31
4. Introduction	5	7.1.2 Trusted Certificates	32
4.1 Overview	5	7.1.3 Self-Signed Private Certificates	33
4.2 Features	6	7.2 OSD Operation	34
4.3 Requirements	7	7.2.1 OSD Overview	34
4.3.1 General	7	7.2.2 OSD Main Screen	34
4.3.2 External Console	7	7.2.3 OSD Navigation	35
4.3.3 Computers	7	7.2.4 OSD Main Screen Headings	35
4.3.4 KVM Adapter Cables	7	7.2.5 OSD Functions	35
4.3.5 Adapter Cable Resolutions	8	7.3 Hotkey Operation	41
4.3.6 Operating Systems	8	7.3.1 Hotkey Port Control	41
4.4 Components	9	7.3.2 Invoking Hotkey Mode	41
4.4.1 Front View	9	7.3.3 Selecting the Active Port	42
4.4.2 Keyboard Module	10	7.3.4 Auto Scan Mode Switching	42
4.4.3 LCD Module	11	7.3.5 Skip Mode Switching	43
4.4.4 Rear View	12	7.3.6 Computer Keyboard / Mouse Reset	43
5. Installation	13	7.3.7 Setting the Hotkey Beeper ON / OFF	43
5.1 General Safety Instructions	13	7.3.8 Setting the Hotkey Key-Combination	44
5.2 Standard Rack Mounting	15	7.3.9 Setting the OSD Hotkey Combination	44
5.3 Front-L Brackets Mounting	16	7.3.10 Setting the Port Operating System	44
5.4 Single-Stage Installation	18	7.3.11 Restore the Default Values	44
5.5 KVM Adapter Cable Installation	19	7.3.12 Hotkey Summary Table	45
5.6 Daisy Chaining	21	7.4 Keyboard Emulation	46
6. KVM Operation	22	7.4.1 Mac Keyboard	46
6.1 Basic Operation	22	7.4.2 Sun Keyboard	47
6.1.1 Opening the Console	22	7.5 Logging In	48
6.1.2 Closing the Console	25	7.5.1 Local Login	48
6.2 LCD OSD Configuration	27	7.5.2 Browser Login	48
6.2.1 LCD Buttons	27	7.5.3 Windows Client AP Login	49
6.2.2 Adjustment Settings	27	7.5.4 Java Client AP Login	51
6.3 Port Selection	28	7.6 User Interface	53
6.4 Hot Plugging	28	7.6.1 Web Browser Main Page	53
6.4.1 Hot Plugging Console Ports	28	7.6.2 AP GUI Main Page	55
6.5 Powering Off and Restarting	29	7.6.3 Control Panel	56
6.6 Port ID Numbering	29		

Table of Contents

7.7 Port Access	75	8. Troubleshooting	125
7.7.1 Sidebar	76	8.1 Administration	125
7.7.2 Filter	78	8.2 General Operation	125
7.7.3 Connections	79	8.3 Windows Client	126
7.7.4 Favorites	80	8.4 Java Client	127
7.7.5 User Preferences	81	8.5 Log Server	127
7.7.6 Sessions	82	8.6 Panel Array Mode	127
7.7.7 Access	83	8.7 Sun Systems	128
7.7.8 Port Configuration	84	8.8 Screen Resolutions Higher than 1280 x 1024	128
7.7.9 Associated Link	85	8.9 Additional Mouse Synchronization Procedures	129
7.7.10 Occupy Timeout	85	8.9.1 Windows	129
7.8 User Management	86	8.9.2 Sun / Linux	130
7.8.1 Users	87	8.10 Clear Login Information	131
7.8.2 Device Assignment	90	8.11 OSD Factory Default Settings	132
7.9 Device Management	91	9. Specifications	133
7.9.1 KVM Devices	91	10. Warranty	135
7.9.2 Operating Mode	92		
7.9.3 Network	93		
7.9.4 ANMS	95		
7.9.5 Security	98		
7.9.6 Date/Time	104		
7.10 Log	105		
7.10.1 Log Information	106		
7.11 Maintenance	107		
7.11.1 Device IP Card Firmware Upgrade	108		
7.11.2 Mainboard and KVM Adapter Cable Firmware Upgrade	108		
7.11.3 Recovering from Failed Firmware Upgrade	110		
7.11.4 Backup/Restore	111		
7.11.5 Ping Host	112		
7.11.6 System Operation	113		
7.12 Download	113		
7.13 Port Operation	114		
7.13.1 Connecting to a Port	114		
7.13.2 Port Toolbar	115		
7.13.3 Panel Array Mode	117		
7.13.4 Multiuser Operation	118		
7.14 Log Server	119		
7.14.1 Log Server Installation	119		
7.14.2 Log Server Start Up	120		
7.14.3 The Log Server Main Screen	123		

1. FCC Information

This is an FCC Class A product. This device complies with part 15 of the FCC Rules. Operation is subject to the following two conditions: (1) This device may not cause harmful interference, and (2) this device must accept any interference received, including interference that may cause undesired operation.

Note: *This equipment has been tested and found to comply with the limits for a Class A digital device, pursuant to part 15 of the FCC Rules. These limits are designed to provide reasonable protection against harmful interference when the equipment is operated in a commercial environment. This equipment generates, uses, and can radiate radio frequency energy and, if not installed and used in accordance with the instruction manual, may cause harmful interference to radio communications. Operation of this equipment in a residential area is likely to cause harmful interference in which case the user will be required to correct the interference at his own expense. The user must use shielded cables and connectors with this equipment. Any changes or modifications to this equipment not expressly approved by Eaton could void the user's authority to operate this equipment.*

2. User Notice

All information, documentation, and specifications contained in this manual are subject to change without prior notification by the manufacturer. The manufacturer makes no representations or warranties, either expressed or implied, with respect to the contents hereof and specifically disclaims any warranties as to merchantability or fitness for any particular purpose. Any of the manufacturer's software described in this manual is sold or licensed "as is." Should the programs prove defective following their purchase, the buyer (and not the manufacturer, its distributor, or its dealer), assumes the entire cost of all necessary servicing, repair and any incidental or consequential damages resulting from any defect in the software.

The manufacturer of this system is not responsible for any radio and/or TV interference caused by unauthorized modifications to this device. It is the responsibility of the user to correct such interference.

The manufacturer is not responsible for any damage incurred in the operation of this system if the correct operational voltage setting was not selected prior to operation. PLEASE VERIFY THAT THE VOLTAGE SETTING IS CORRECT BEFORE USE.

3. Package Contents

This package consists of:

- B064C-16-1-IP NetDirector® 16-Port Cat5 KVM over IP Switch
- Power Cord
- Standard Rack-Mount Kit
- Firmware Upgrade Cable
- User Documentation

4. Introduction

4.1 Overview

The B064C-16-1-IP NetDirector Dual-Rail LCD KVM Switch is a control unit that allows secure access and control of up to 16 computers from a single KVM (keyboard, video, and mouse) console. A single unit can control up to 16 computers. It consists of an integrated LED-backlit LCD monitor, keyboard, and touchpad in a 1U rack-mountable retractable sliding housing.

The B064C-16-1-IP features IP-based connectivity that allows one local operator and multiple remote operators to concurrently monitor and access the computers on your installation. It uses TCP/IP for its communications protocol, allowing it to be accessed from any computer on the LAN, WAN, or Internet – whether that computer is located down the hall, down the street, or halfway around the world.

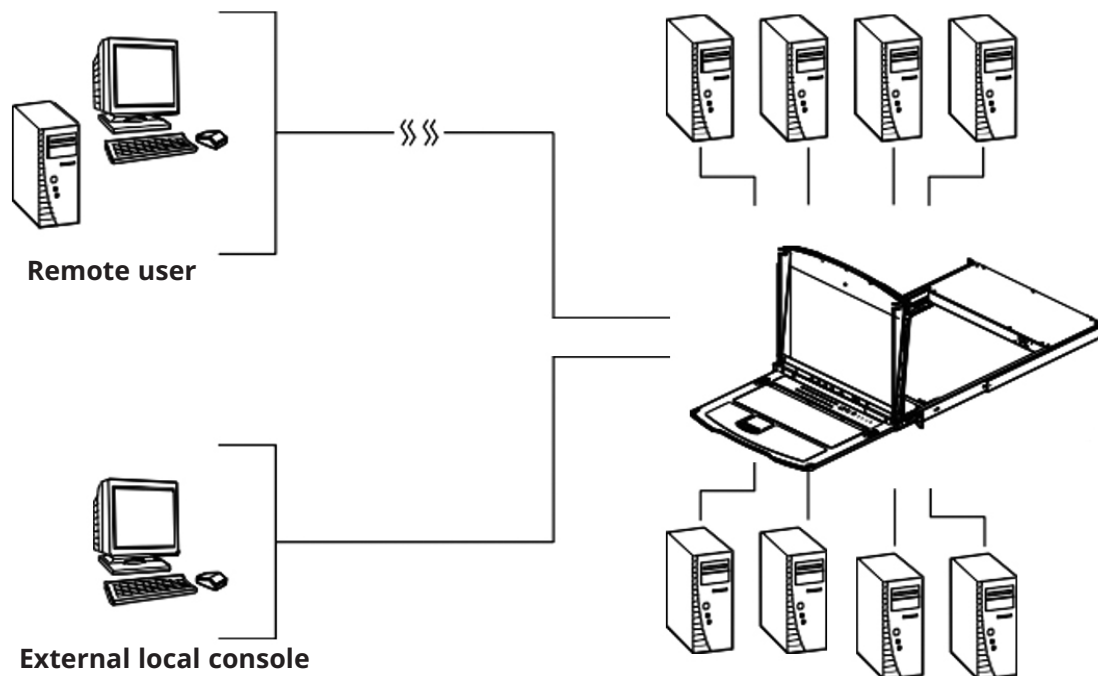

By daisy-chaining up to 15 additional switches, as many as 256 computers can be controlled from the original KVM console. An auto-sensing function recognizes the position of each station on the chain, eliminating the need to manually set the position, and a two digit seven-segment LED display on the keyboard module that shows each station's position for easy identification.

Compact, high-density, RJ45 connectors and CAT 5e/6 cable make for a compact, efficient, wiring configuration, while the use of PS/2 and USB KVM Adapter Cables to link to the computers, permits any combination of Windows, Macs, Sun computers, and serial devices to coexist on the installation.

4. Introduction

4.2 Features

Hardware

- Integrated KVM console with LED-backlit LCD monitor in a dual-rail housing.
- A single console controls up to 16 computers.
- Daisy-chain up to 15 additional B022-U08 KVM switches to control up to 256 computers.
- One bus for remote KVM over IP access.
- Space-saving RJ45 connectors and Cat 5e/6 cabling.
- KVM adapter cables designed with auto conversion to allow interface combinations (PS/2, USB, Sun and serial) to control all computer types.
- Superior Video Quality - supports input video resolutions up to 1920 x 1080 @ 60 Hz up to 98 ft. (30 m), 1600 x 1200 @ 60 Hz up to 131 ft. (40 m), 1280 x 1024 @ 75 Hz up to 164 ft. (50 m) and 1920 x 1200 @ 60 Hz up to 164 ft. (50 m).
- Extra console ports manage computers on the LCD KVM switch from an external console (monitor, USB or PS/2 keyboard, and USB or PS/2 mouse).
- Multiplatform support: PC, Mac, Sun and serial.
- Supports an external USB mouse.
- Dual-rail housing is slightly less than 1U with top and bottom clearance for smooth operation in 1U of rack space.
- Dual-rail LCD monitor slides independently of the keyboard/touchpad.
- LCD module rotates up to 120 degrees for a comfortable viewing angle.

Management

- Supports 64 user accounts - up to 32 users can be logged in at the same time for control and management.
- End session feature - administrators can terminate any running session.
- Adapter ID stores port information allowing administrators to relocate servers to different ports without having to reconfigure the adapters and switch.
- Port Share Mode allows multiple users to gain access to a server simultaneously.
- Event logging and Windows-based Log Server support.
- Local Log Event.
- Firmware upgradeable.
- IPv6 capable.

Easy-to-Use Interface

- Easy computer selection via pushbuttons, Hotkey Mode, OSD (On-Screen Display) and Browser-based GUI.
- Local Console, Browser, and AP GUIs offer a unified multi language interface to minimize user training time and increase productivity.
- Multi-platform client support (Windows, Mac OS X, Linux, Sun).
- Multi-browser support: Internet Explorer, Chrome, Firefox, Safari, Opera, Netscape.
- Browser-based UI in pure Web technology allows administrators to perform administrative tasks without the need for Java to be pre-installed.
- Panel Array Mode.
- Keyboard broadcast - keyboard input can be duplicated on all the attached servers.
- Keyboard Language support: English (US), English (UK), German, German (Swiss), French, Spanish, Traditional Chinese, Japanese, Korean, Swedish, Italian, Russian, Hungarian and Greek.

4. Introduction

Advanced Security

- Remote authentication support: RADIUS, LDAP, LDAPS and MS Active Directory.
- Supports TLS 1.2 data encryption and RSA 2048-bit certificates to secure user log in from a browser.
- Flexible encryption design allows users to choose any combination of DES, 3DES, AES, RC4, or Random for independent keyboard/mouse and video data encryption.
- IP/MAC Filter support for enhanced security protection.
- Configurable user and group permissions for server access and control.

Virtual Remote Desktop

- Video quality and video tolerance can be adjusted to optimize data transfer speed; monochrome color depth setting, threshold and noise settings for compression of the data bandwidth in low bandwidth situations.
- Full-screen or sizable and scalable Virtual Remote Desktop.
- Message board feature allows logged-in users to communicate.
- Automatically synchronizes the local and remote mouse movements.
- On-screen keyboard with multi language support.
- BIOS-level access.

4.3 Requirements

4.3.1 General

- Computers with at least a P 4 2 GHz processor and 1 GB RAM.
- Browsers must support TLS 1.2 encryption.
- Network transfer speed of at least 512 kbps is recommended.
- For the Log Server, Microsoft Jet OLEDB 4.0 or higher driver installed.

4.3.2 External Console

- VGA, SVGA, or Multisync monitor capable of the highest resolution that you will be using on any computer in the installation.
- USB or PS/2 style mouse.
- USB or PS/2 style keyboard.

4.3.3 Computers

- VGA, SVGA or Multisync port.
- USB Type-A port and USB host controller (for USB KVM Adapter Cable Connection).
- 6-pin mini-DIN keyboard and mouse ports (for PS/2 KVM Adapter Cable Connection).

Note:

• *The integrated LCD monitor's maximum screen resolution is 1280 x 1024 @ 75 Hz. To use a higher setting for the screen resolutions of the attached computers, refer to 8.8 Screen Resolutions Higher than 1280 x 1024.*

4.3.4 KVM Adapter Cables

- Cat 5e/6 cable is required to connect the B064C-16-1-IP to one of the KVM adapters.

4. Introduction

4.3.5 Adapter Cable Resolutions

The table below provides the maximum resolutions available for each KVM adapter.

Model No.	Computer Ports	Video Resolution	
B055 Series	B055-001-PS2	2 x PS/2, 1 x HDB-15	1600 x 1200
	B055-001-UDV	2 x USB Type A, 1 x DVI-D	1920 x 1080 (30 m)
	B055-001-UHD	2 x USB Type A, 1 x HDMI	
	B055-001-UDP	2 x USB Type A, 1 x DisplayPort	
	B055-001-USB	1 x USB Type A, 1 x HDB-15	
	B055-001-C	1 x USB-C	1920 x 1200 (50 m)

4.3.6 Operating Systems

Supported operating systems are shown in the table below:

OS	Version	
Windows	NT ¹ , Server 2003, Server 2008, 2000 or later	
Linux ²	RedHat	9.0, Fedora or later, RHEL AS 4, RHEL 5
	SuSE	10 or later, OpenSUSE 10.2; SLES 10 SP1
	Debian	3.1, 4.0
	Ubuntu	7.04, 7.10
UNIX	IBM	AIX4.3, 5L (V5.2,V5.3), V6 (V6.1)
	FreeBSD	5.5, 6.1, 6.2
Novell	Netware	5.0 or later
Sun	Solaris 8, 9, 10	
Mac	9.0, 9.1, 10.1, 10.2, 10.3, 10.4, 10.5	
DOS	6.2 or later ¹	

1. Does not support USB.

2. Kernels below 2.6 do not support USB 2.0.

4. Introduction

4.4 Components

4.4.1 Front View

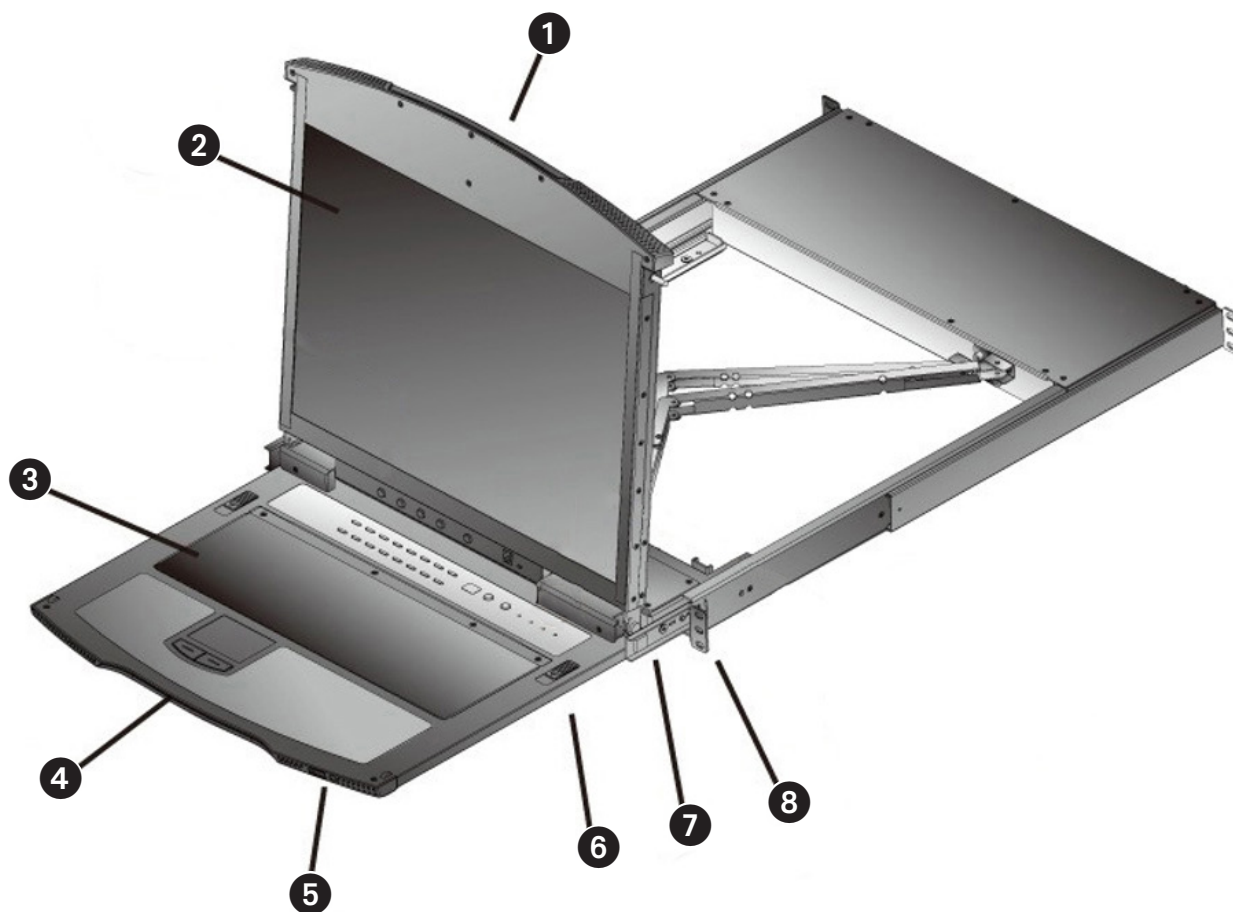

1	Upper Handle	Pull to slide the LCD module out; push to slide the module in. See 6.1.1 Opening the Console for more information.
2	LCD Module	Refer to 4.4.2 LCD Module for a detailed description.
3	Keyboard Module	Refer to 4.4.3 Keyboard Module for a detailed description.
4	Lower Handle	Pull to slide the keyboard module out. See 6.1.1 Opening the Console for more information.
5	Power LED	Illuminates (blue) to indicate the unit is receiving power.
6	Keyboard Release Catch	These (one on each side) release the keyboard module to slide it out.
7	LCD Release Catch	These (one on each side) release the LCD module to slide it out.
8	Rack-Mount Brackets	The rack-mount brackets located at each corner of the unit secure the chassis to a system rack. See 5.2 Standard Rack Mounting for more information.

4. Introduction

4.4.2 Keyboard Module

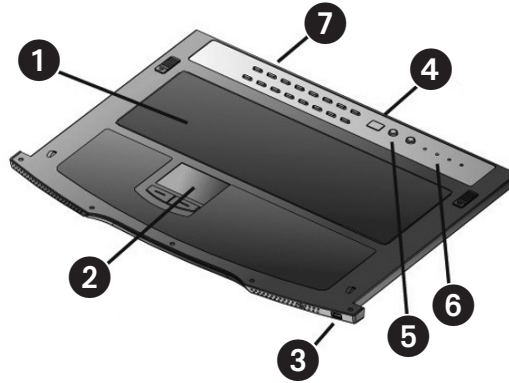

1	Keyboard	Standard 105-key QWERTY keyboard.
2	Touchpad	Standard mouse touchpad.
3	External Mouse Port	A USB Type-A mouse port is provided for users who prefer to use an external mouse.
4	Station ID LED	In a daisy-chained installation, the station ID of the currently selected station displays as a 2-digit figure in this panel. See 6.6 Port ID Numbering for more details.
5	Station Selection Area	<ul style="list-style-type: none"> • The LED displays the station number that the port with the KVM focus is located on. • The left button shifts the KVM focus down the chain (station 2 → station 1, etc.). After station 1, it cycles back to the last station. • The right button shifts the KVM focus up the chain. After the last station, it cycles to station 1.
6	Lock LEDs and Reset Button	The Num Lock, Caps Lock, Scroll Lock LEDs are located here. A reset button is located just to the right of the Lock LEDs. Press this button using a thin object to perform a system reset.
7	Port Selection Buttons and LEDs	To access a port on the currently selected station, press its corresponding port selection button. Indicator LEDs are built into the switches: <ul style="list-style-type: none"> • An On-Line LED illuminates to indicate the computer attached to its corresponding port is up and running. • A Selected LED illuminates to indicate which port has the KVM focus.

4. Introduction

4.4.3 LCD Module

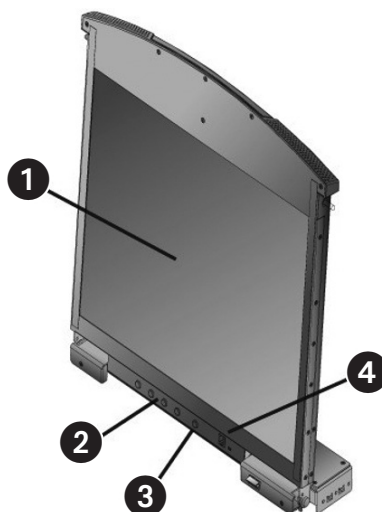

❶	LCD Display	To access the LCD monitor, slide the LCD module out and flip up the cover. See 6.1.1 Opening the Console for more information.
❷	LCD Controls	These buttons control the position and picture settings of the LCD display. See 6.2 LCD OSD Configuration for more information.
❸	LCD On / Off Button	Push this button to turn the LCD monitor on and off. The button illuminates when the LCD monitor is off to indicate that only the monitor is off and not the KVM switch itself.
❹	Firmware Upgrade Section	Firmware upgrade port: The firmware upgrade cable plugs into this RJ11 port to transfer firmware upgrade data from the administrator's computer to the B064C-16-1-IP. Firmware upgrade switch: During normal operation, this switch should be in the NORMAL position. If firmware upgrade fails, this switch is used to recover the settings. See 7.11.3 Recovering from Failed Firmware Upgrade for more information.

4. Introduction

4.4.4 Rear View

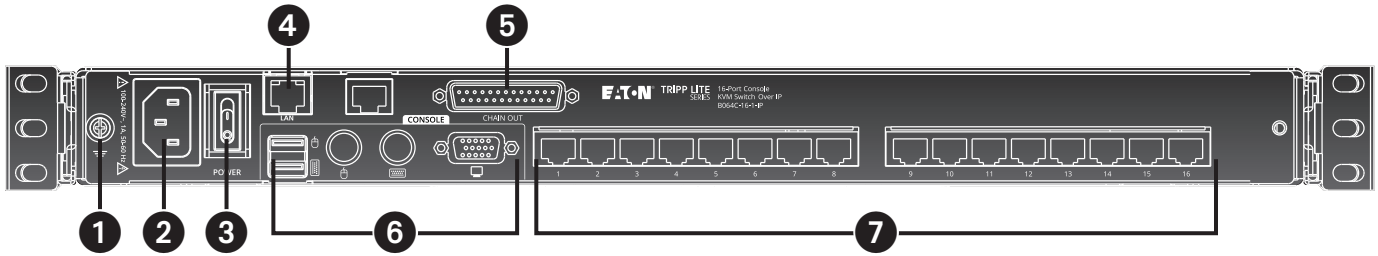

1	Grounding Terminal	The grounding wire used to ground the switch attaches here.
2	Power Socket	This is a standard C14 AC power socket. The power cord from an AC source plugs in here.
3	Power Switch	This is a standard rocker switch that powers the unit on and off.
4	LAN Port	The cable that connects the to the LAN plugs in here. The LEDs indicate data transmission speed: orange 100 Mbps / green: 1000 Mbps.
5	Daisy-Chain Port	When daisy-chaining units (see 5.6 Daisy Chaining), the daisy-chain cable plugs in here.
6	Local Console Port Section	If this is a single-station installation or the first station of a daisy-chained installation, the keyboard, monitor and mouse for the local console plug in here.
7	KVM Port Section	The Cat 5e/6 cables that link to the KVM Adapter Cables plug in here.

5. Installation

5.1 General Safety Instructions

- Read all of these instructions. Save them for future reference.
- Follow all warnings and instructions marked on the device.
- This product is for indoor use only.
- Do not place the device on any unstable surface (cart, stand, table, etc.). If the device falls, serious damage will result.
- Do not use the device near water.
- Do not place the device near or over radiators or heat registers.
- The device cabinet is provided with slots and openings to allow for adequate ventilation. To ensure reliable operation and to protect against overheating, these openings must never be blocked or covered.
- The device should never be placed on a soft surface (bed, sofa, rug, etc.) as this will block its ventilation openings. Likewise, the device should not be placed in a built-in enclosure unless adequate ventilation has been provided.
- Never spill liquid of any kind on the device.
- Unplug the device from the wall outlet before cleaning. Do not use liquid or aerosol cleaners. Use a damp cloth for cleaning.
- The device should be operated from the type of power source indicated on the marking label. If you are not sure of the type of power available, consult your dealer or local power utility.
- The device is designed for IT power distribution systems with 230V phase-to-phase voltage.
- To prevent damage to your installation, it is important that all devices are properly grounded.
- The device is equipped with a 3-wire grounding type plug. This is a safety feature. If you are unable to insert the plug into the outlet, contact your electrician to replace your obsolete outlet. Always follow your local/national wiring codes.
- Do not allow anything to rest on the power cord or cables. Route the power cord and cables so that they cannot be stepped on or tripped over.
- Avoid circuit overloads. Before connecting equipment to a circuit, know the power supply's limit and never exceed it. Always review the electrical specifications of a circuit to ensure that you are not creating a dangerous condition or that one does not already exist. Circuit overloads can cause a fire and destroy equipment.
- If an extension cord is used with this device make sure that the total of the ampere ratings of all products used on this cord does not exceed the extension cord ampere rating. Make sure that the total of all products plugged into the wall outlet does not exceed 15 amperes.
- To help protect your system from sudden, transient increases and decreases in electrical power, use a surge suppressor, line conditioner or uninterruptible power supply (UPS).
- Position system cables and power cables carefully; be sure nothing rests on any cables.
- Never push objects of any kind into or through cabinet slots. They may touch dangerous voltage points or short out parts, resulting in a risk of fire or electrical shock.
- Do not attempt to service the device yourself. Refer all servicing to qualified service personnel.
- If the following conditions occur, unplug the device from the wall outlet and bring it to qualified service personnel for repair:
 - o The power cord or plug has become damaged or frayed.
 - o Liquid has been spilled into the device.
 - o The device has been exposed to rain or water.
 - o The device has been dropped, or the cabinet has been damaged.
 - o The device exhibits a distinct change in performance, indicating a need for service.
- The device does not operate normally when the operating instructions are followed.
- Only adjust those controls that are covered in the operating instructions.
- Improper adjustment of other controls may result in damage that will require extensive work by a qualified technician to repair.
- Do not connect the RJ11 connector marked "UPGRADE" to a public telecommunications network.

5. Installation

Rack-Mounting Safety Instructions

- Prior to installation, ensure KVM is powered OFF and de-energized.
- Before working on the rack, make sure the stabilizers are secured to the rack, extended to the floor and that the full weight of the rack rests on the floor. Install front and side stabilizers on a single rack or front stabilizers for joined multiple racks before working on the rack.
- Always load the rack from the bottom to top; load the heaviest item in the rack first.
- Make sure the rack is level and stable before extending a device from the rack.
- Use caution when pressing the device rail release latches and sliding a device into or out of a rack; the slide rails can pinch your fingers.
- After a device is inserted into the rack, carefully extend the rail into a locking position, then slide the device into the rack.
- Do not overload the AC supply branch circuit that provides power to the rack. The total rack load should not exceed 80 percent of the branch circuit rating.
- Make sure that all equipment used on the rack - including power strips and other electrical connectors - are properly grounded.
- Ensure that proper airflow is provided to devices in the rack.
- Ensure that the operating ambient temperature of the rack environment does not exceed the maximum ambient temperature specified for the equipment by the manufacturer.
- Do not step on or stand on any device when servicing other devices in a rack.
- **Caution:** Slide/rail (LCD KVM) mounted equipment is not to be used as a shelf or a workspace.

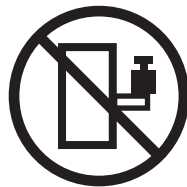

5. Installation

5.2 Standard Rack Mounting

A standard rack-mount kit is provided with your B064C-16-1-IP. The kit enables the switch to be mounted in a rack with a depth of 15.5-30 in. (42-77 cm).

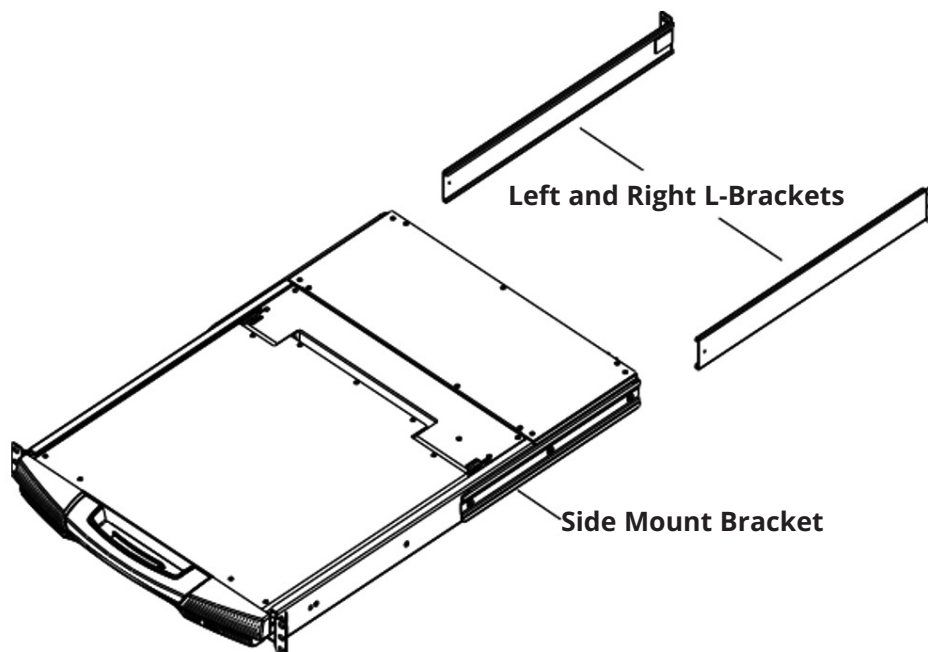

Notes:

- Two people are required to mount the console.
- The standard rack-mount kit does not include screws or cage nuts.
- If you need additional screws or cage nuts, contact your rack dealer.

To rack mount the switch:

1. Have one person position the unit in the rack and hold it steady, then the second person attaches the front brackets to the rack.

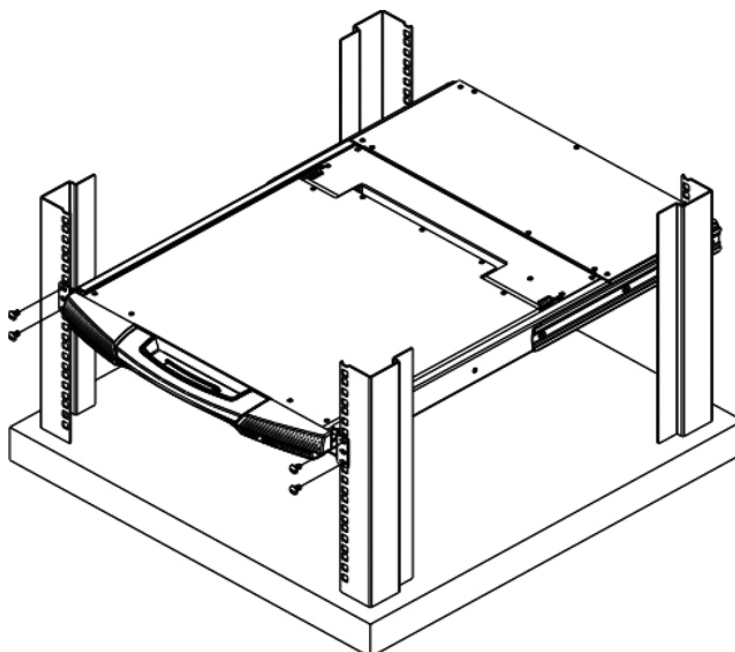

5. Installation

2. While the first person continues to hold the unit in place, the second person slides the left and right L-brackets into the unit's side mount brackets from the rear. Secure the brackets in place using the four screws.

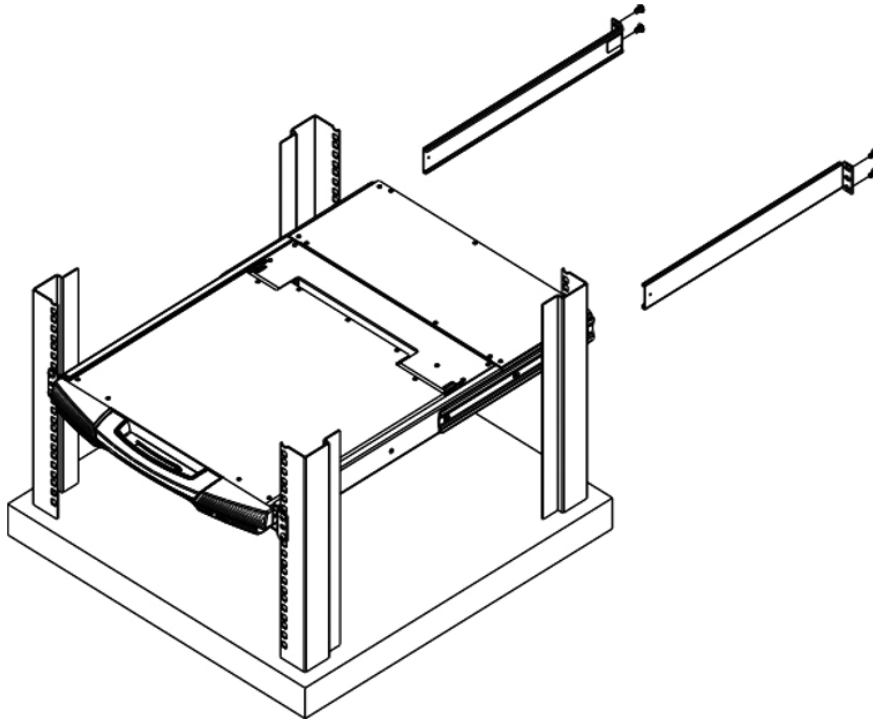

3. Once the L-brackets are secured, tighten all the screws.

Allow at least 2 in. (5.1 cm) on each side for proper ventilation, and at least 5 in. (12.7 cm) at the back for power cord and cable clearance.

5.3 Front-L Brackets Mounting

To better enable the tilt function of the LCD screen, install the front L-brackets at the front of the rack.

1. To attach the left and right front L-brackets to the front of the rack, first place screws in the tabs to secure them in place.

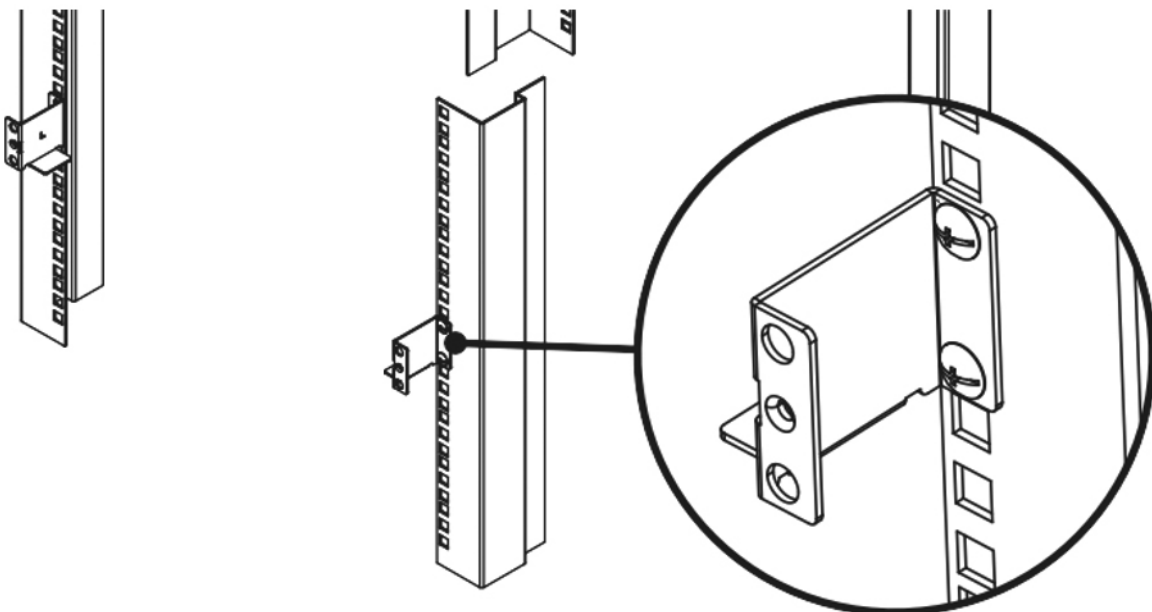

5. Installation

Note: Rack screws are not provided to mount the unit. We recommend using M5 x P0.8 screws.

2. Have one person position the unit in the rack and hold it steady. Then have the second person screw the front brackets to the front-L bracket.

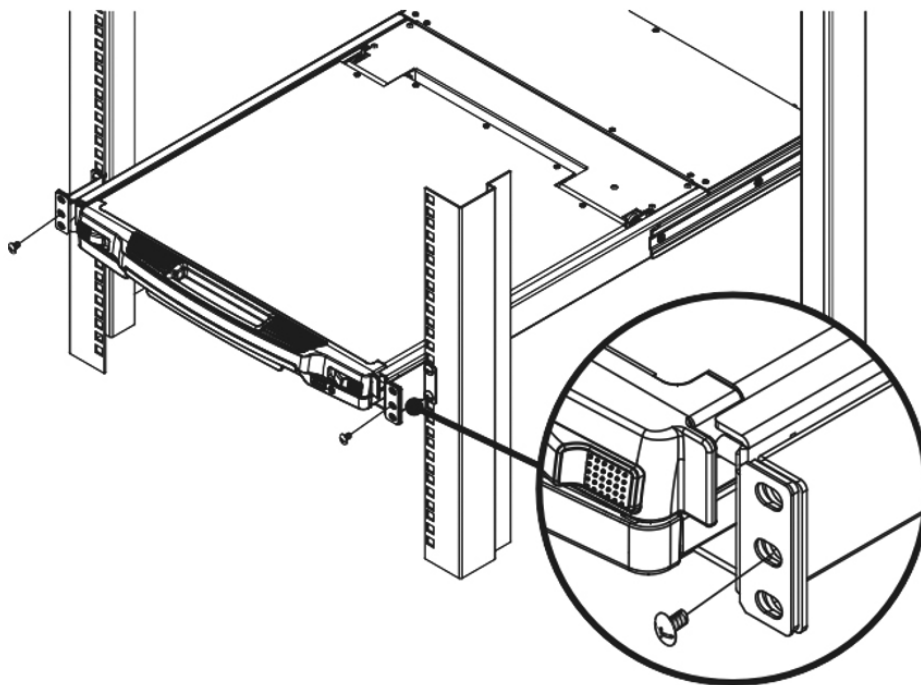

3. While the first person continues to hold the unit in place, the second person slides the left and right L-brackets into the unit's side mount brackets from the rear. Secure the bracket using four screws.

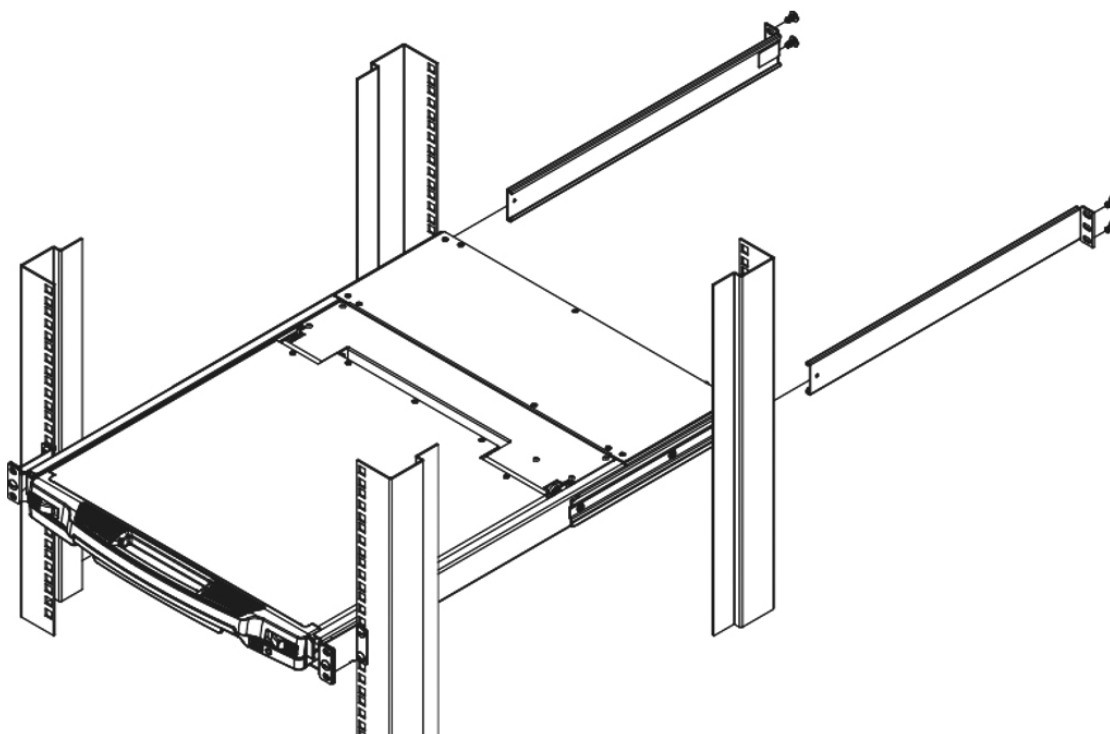

4. Once the L-brackets are secured, tighten all screws.

Allow at least 2 in. (5.1 cm) on each side for proper ventilation, and at least 5 in. (12.7 cm) at the back for power cord and cable clearance.

5. Installation

5.4 Single-Stage Installation

In a single-stage installation, there are no additional switches daisy-chained down from the first unit. To set up your console KVM switch, refer to the following steps and installation diagram.

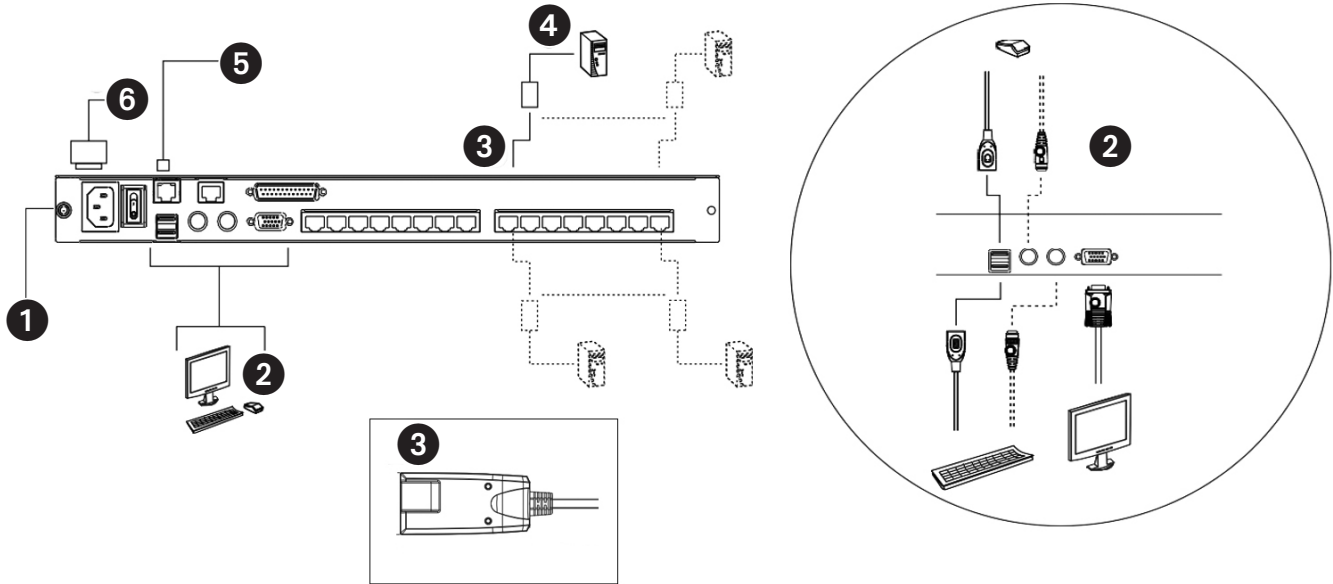

- 1 Ground the unit by connecting one end of a grounding wire to the grounding terminal and the other end of the wire to a suitable grounded object.
Note: Do not omit this step. Proper grounding helps to prevent damage to the unit from power surges or static electricity.
- 2 **(Optional)** If you choose to install an external console, plug your keyboard, monitor and mouse into the console ports located on the switch's rear panel. The ports are color coded and marked with an icon for easy identification.
- 3 For each computer you are installing, use Cat5e cable to connect any available KVM port to a KVM adapter cable that is appropriate for the computer you are installing (see **4.3.4 KVM Adapter Cables** for details).
Note: The maximum supported distance to the adapter cable is 164 ft. (50 m).
- 4 Connect the KVM Adapter cable to the computer. Refer to the **KVM Adapter Cable Installation Diagram** to plug the adapter cable connectors into their respective ports on the computers you are installing.
- 5 Plug the LAN or WAN cable into the B064C-16-1-IP's LAN port.
- 6 Connect the power cord to the switch and to an AC power source.

Once the B064C-16-1-IP is connected properly, you can turn on the power. After the switch is powered on, then turn on the servers.

5. Installation

5.5 KVM Adapter Cable Installation

B055-001-PS2

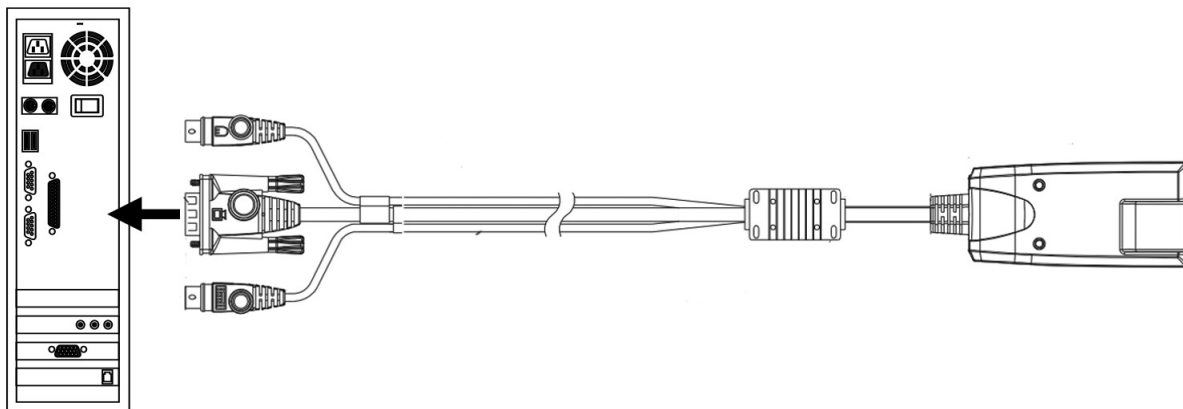

B055-001-USB

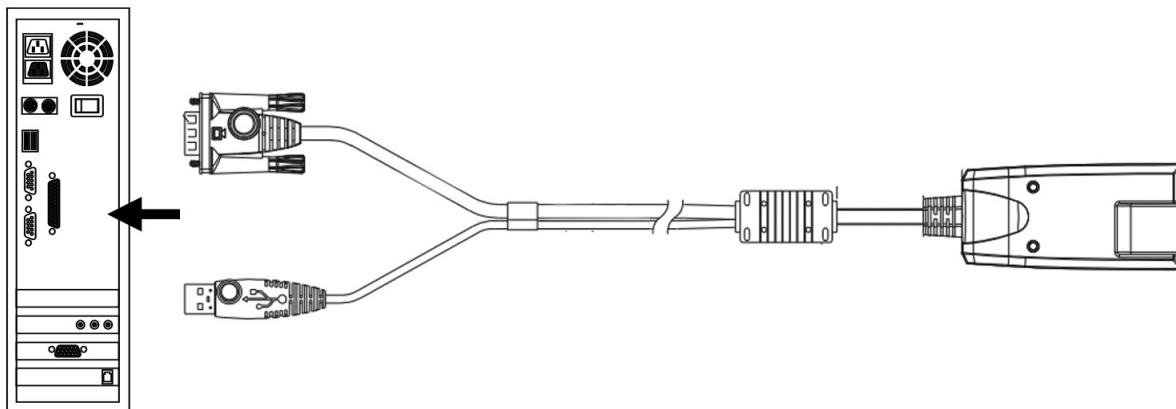

B055-001-UDV

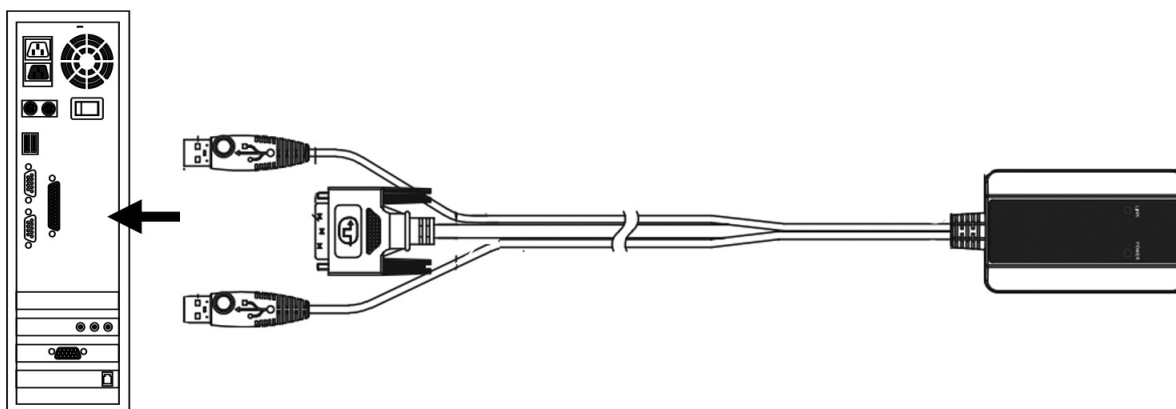

5. Installation

B055-001-UHD

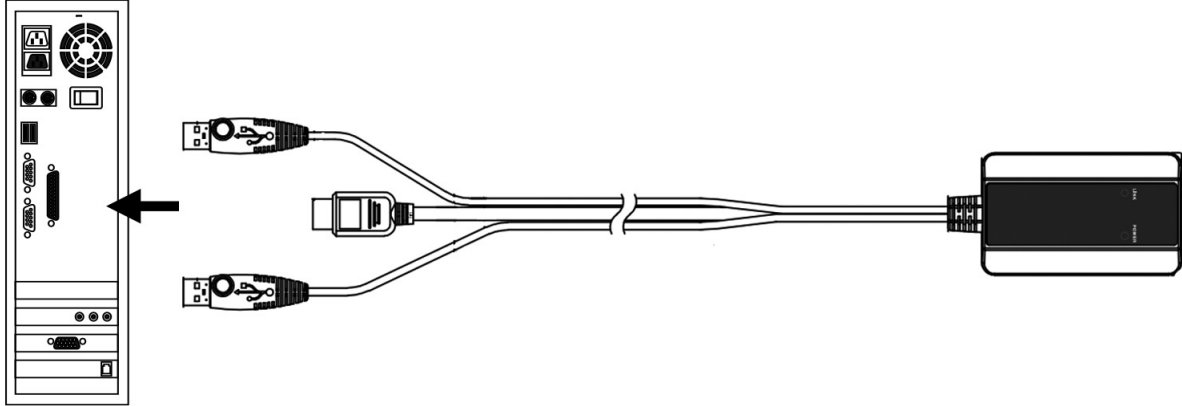

B055-001-UDP

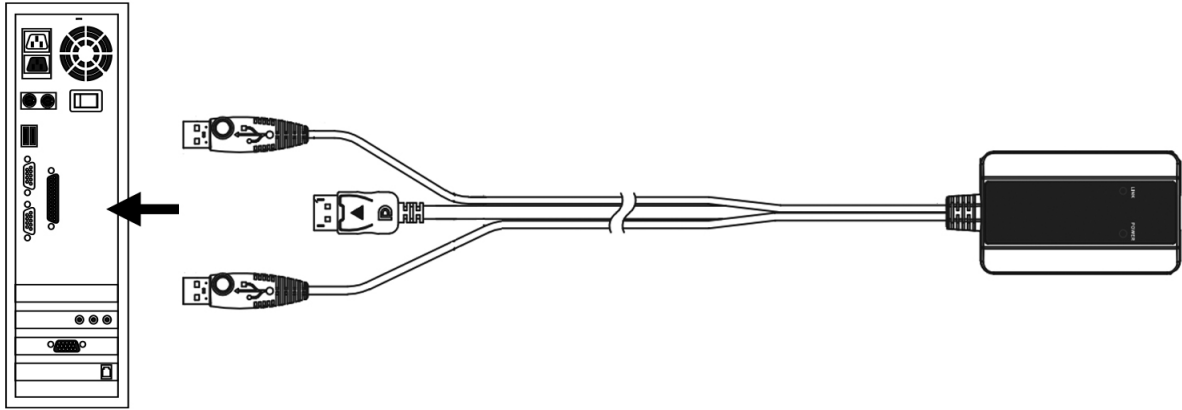

5. Installation

5.6 Daisy Chaining

To set up a daisy-chained installation, make sure that power to all the devices you will be connecting up has been turned off.

B064C-16-1-IP rear view

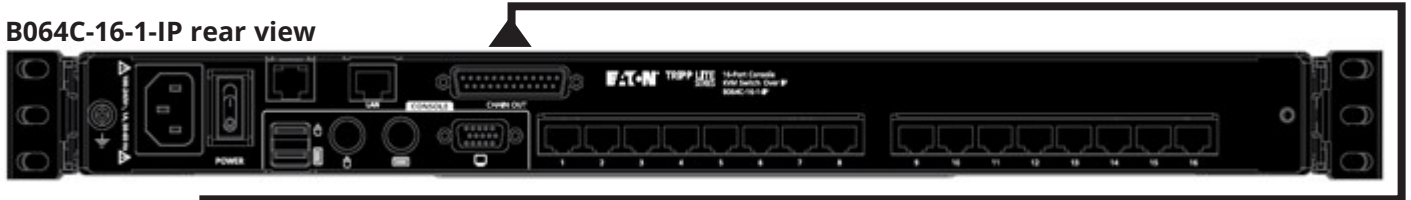

B022-U08 rear view

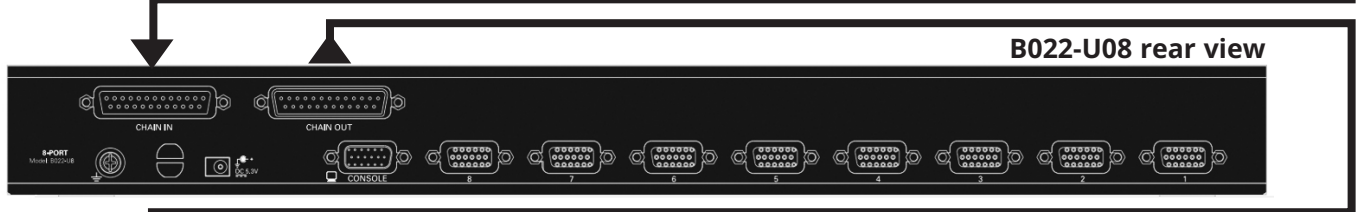

B022-U08 rear view

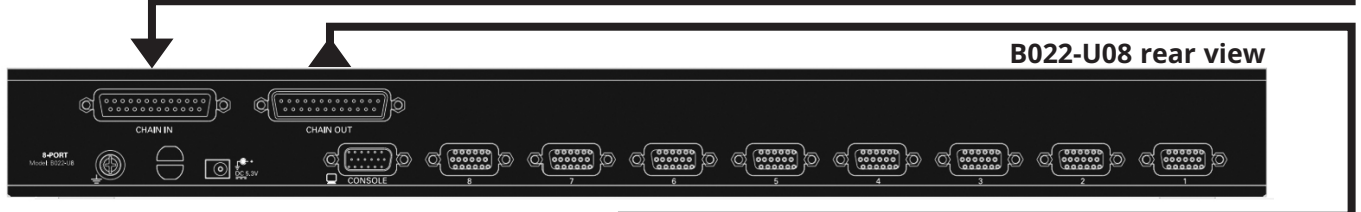

1. Use a daisy-chain set to connect the chain out port of the first station to the chain in port of the chained compatible KVM Switch unit (first station out to second station in, second station out to third station in, etc.).

Notes:

- You cannot use the chain in port of the first station.
- Daisy-chain cable sets require a separate purchase. See your dealer for details.

2. Connect the computers and the switch according to the instructions provided in **5.4 Single-Stage Installation**.
3. Repeat the above steps for any other switches you want to add to the chain.
4. Plug in the power cord for the first station. Wait for the unit to acquire its station ID and display it on the station ID LED. The station ID for the first stage unit is 01, the ID for the second stage unit is 02, the ID for the third stage unit is 03, etc.
5. Power on each additional station in the installation (second station, then third station, etc.). In each case, wait for the station ID to be acquired and displayed before powering on the next station.
6. Once all the stations are up, power on the computers.

6. KVM Operation

6.1 Basic Operation

6.1.1 Opening the Console

The B064C-16-1-IP consists of two modules: an LCD display module located under the top cover and a keyboard / touchpad module below the LCD module.

The modules can slide together or independently. This allows you to have the LCD display available for viewing while the keyboard / touchpad module is conveniently out of the way when not in use.

Opening Separately

1. Pull the release catch to disengage the console and pull the top panel slightly toward you. Once the console has been released, let go of the release catch.

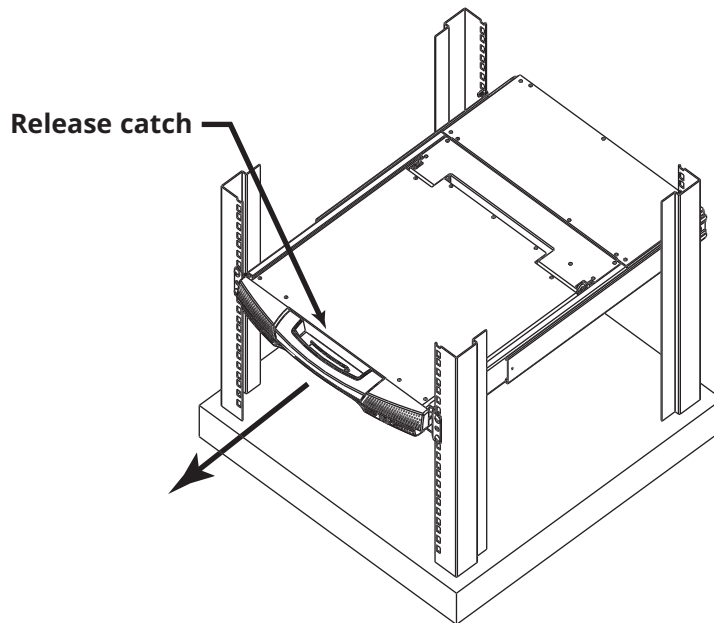

2. Pull out the top panel completely until it clicks into place.

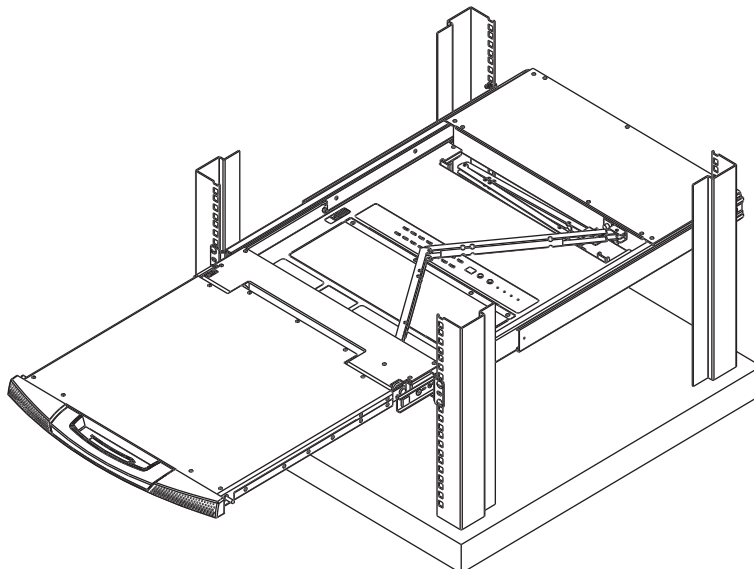

6. KVM Operation

3. Rotate the top panel backward to expose the LCD screen.

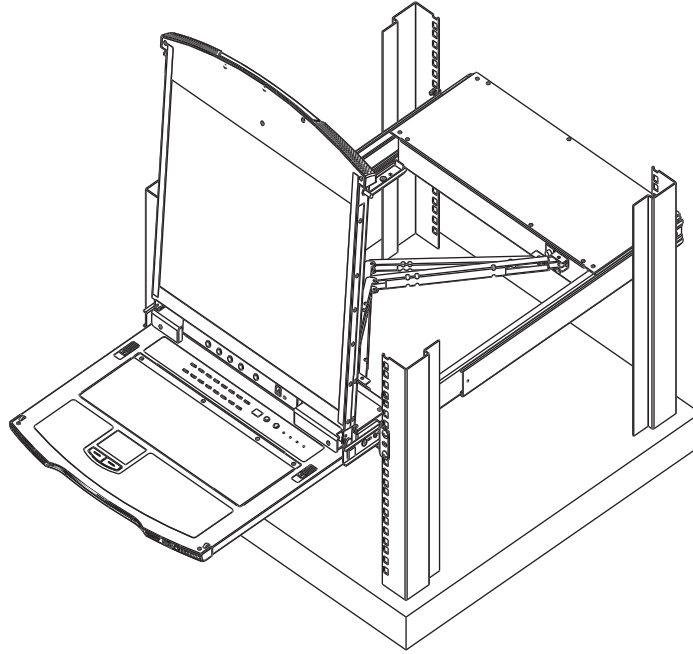

4. Reach underneath and pull out the keyboard module completely until it clicks into place.

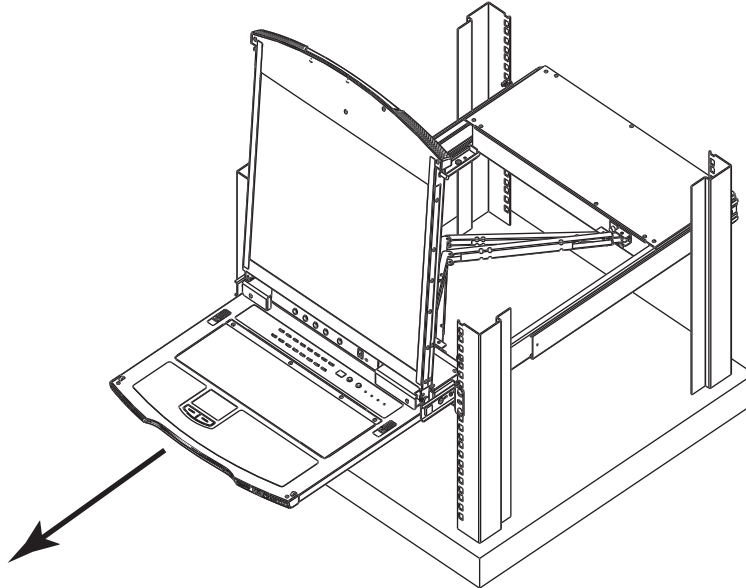

Opening Together

Refer to the diagrams in the Opening Separately section as you do the following:

1. While holding the release catch, pull the top and bottom panels out until the keyboard module clicks into place.
Note: Once the console has been released, release the release catch.
2. Pull the top panel the rest of the way out until it clicks into place.
3. Rotate the top panel backward to expose the LCD screen.

6. KVM Operation

Operating Precautions



The maximum load bearing capacity of the keyboard module is 44 lb. (20 kg). Failure to heed the following information may result in damage to the keyboard module:

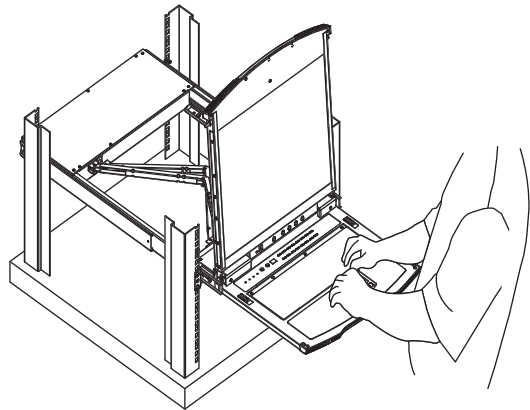

Correct

Rest your hands and arms lightly on the keyboard module as you work.

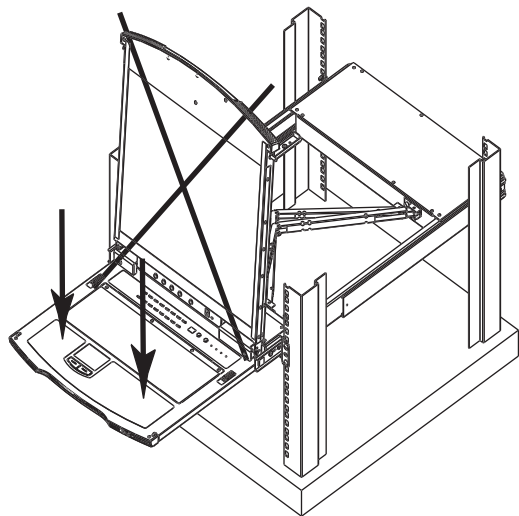

Incorrect

- DO NOT lean your body weight on the keyboard module.
- DO NOT place heavy objects on the keyboard module.

6. KVM Operation

6.1.2 Closing the Console

1. Pull the release catches located on each side of the keyboard toward you to release the keyboard module, then slide in the module slightly.

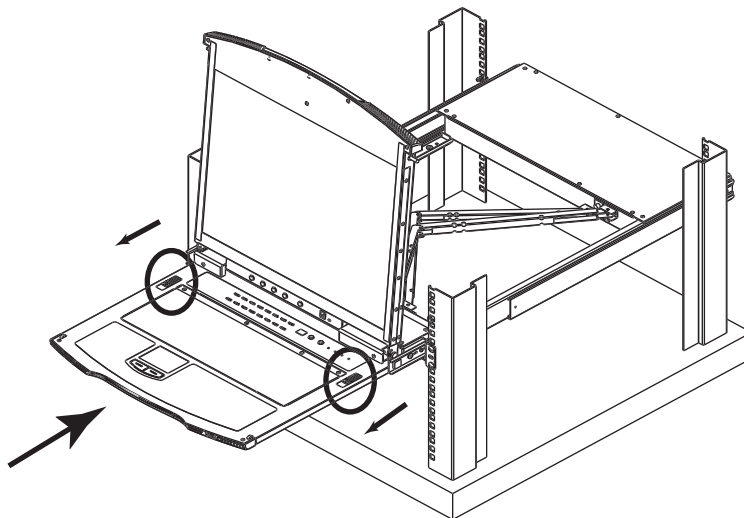

2. Release the release catches. Using the front handle, push in the keyboard module completely.

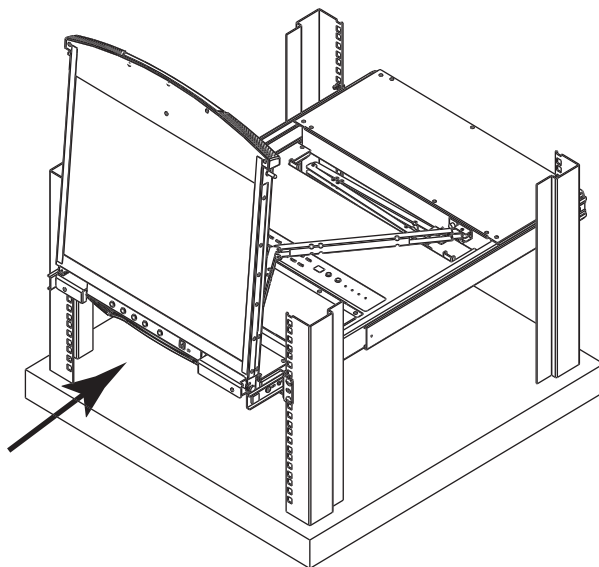

6. KVM Operation

3. Rotate the LCD module completely, then pull the rear release catches to release the LCD module.

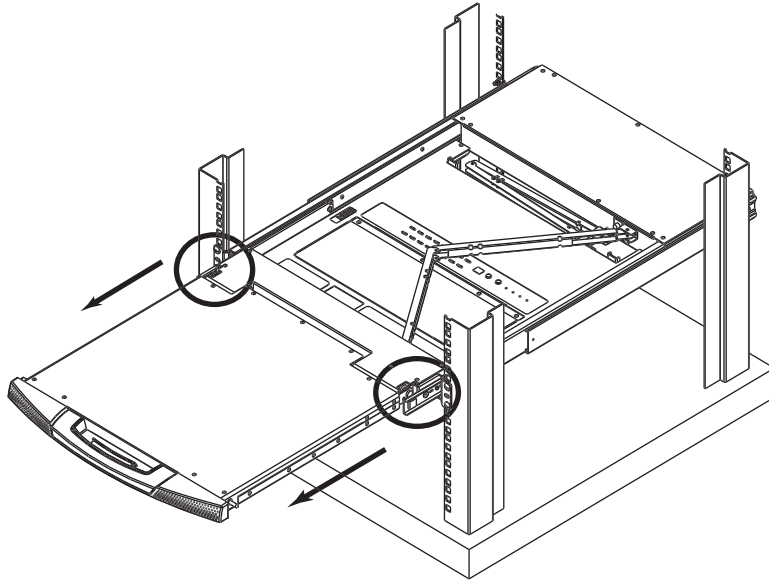

4. Using the front handle, push in the module completely.

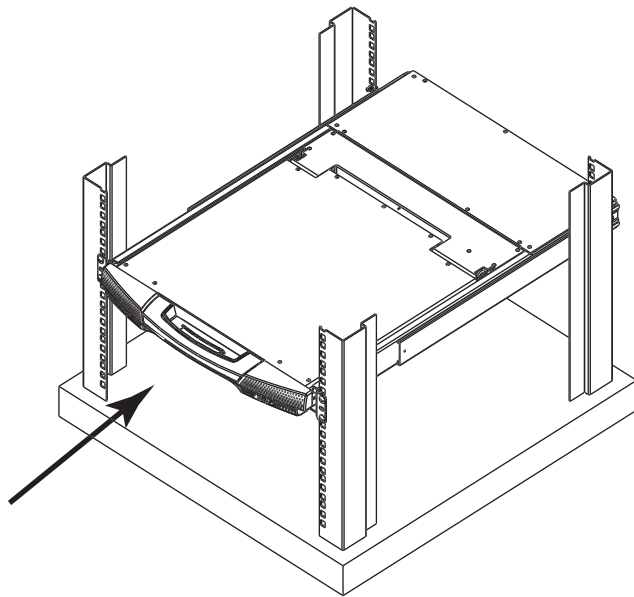



6. KVM Operation

6.2 LCD OSD Configuration

6.2.1 LCD Buttons

The LCD OSD allows you to set up and configure the LCD display. Four buttons are used to perform the configuration, as described in the table below:

Button	Function
MENU	When you have not entered the LCD OSD Menu function, pressing this button invokes the Menu function and opens the Main Menu.
	When navigating through the menus, this button moves you right or up. When making an adjustment, it increases the value.
	When navigating through the menus, this button moves you left or down. When making an adjustment, it decreases the value.
EXIT	<ul style="list-style-type: none">When you have not entered the LCD OSD Menu function, pressing this button performs an auto adjustment. An auto adjustment automatically configures all settings for the LCD panel to what the OSD considers their optimum values.When you have entered the LCD OSD Menu function, pressing this button exits the current menu and returns you to the previous menu. Use it to leave an adjustment menu when you are satisfied with the adjustment you have made.When you are at the Main Menu, pressing this button exits the LCD OSD.

6.2.2 Adjustment Settings

An explanation of the LCD OSD adjustment settings is provided in the table below:

Setting	Explanation
Brightness	Adjusts the background black level of the screen image.
Contrast	Adjusts the foreground white level of the screen image.
Phase	If pixel jitter or horizontal line noise is visible on the display, your LCD may have the wrong phase setting. Adjust the phase setting to eliminate these problems.
Clock	If vertical banding is visible on the display, your LCD may have the wrong clock setting. Adjust the clock setting to eliminate vertical banding.
H-Position	Positions the display area on the LCD panel horizontally (moves the display area left or right).
V-Position	Positions the display area on the LCD panel vertically (moves the display area up or down).
Color Temperature	Adjusts the color quality of the display. You can adjust the "warmth" value, color balance, etc. The <i>Adjust Color</i> selection has a further submenu that lets you fine tune the RGB values.
Language	Selects the displayed language of the OSD.
OSD Duration	Lets you set the amount of time that the OSD displays on the screen. If there is no input for the amount of time you choose, the OSD turns off.
Reset	Resets the menu and submenu adjustments (except for language settings) to the original factory default settings.

6. KVM Operation

6.3 Port Selection

The B064C-16-1-IP provides three methods to obtain instant access to any computer in your installation: Manual, OSD/ GUI and Hotkeys.

Manual

For manual port selection, simply press the port switch that corresponds to the device you wish to access.

OSD / GUI

The B064C-16-1-IP provides menu-driven interfaces to the computer switching procedure. There are two systems: A text-based OSD when you log in from the local console; and a graphical user interface (GUI) when you log in remotely over the internet.

Hotkeys

Hotkeys allow you to conveniently provide KVM focus to a particular computer from the local console keyboard instead of having to manually select them by pressing port selection switches. See **7.3.1 Hotkey Port Control** for details.

6.4 Hot Plugging

The B064C-16-1-IP supports hot plugging, where components can be removed and added back into the installation by unplugging and replugging their cables from their ports without needing to shut down the unit. For hot plugging to work properly, the procedures described below must be followed:

Hot Plugging Stations

You can switch station positions by simply unplugging from the old parent and plugging into a new one. After you do, in order for the OSD menus to correspond to the change, you must reset the OSD.

Hot Plugging KVM Ports

After switching KVM ports, for the OSD menus to correspond to the change, you must manually reconfigure the OSD information for the new port information.

Note: *If the computer's operating system does not support hot plugging, this function may not work properly.*

6.4.1 Hot Plugging Console Ports

The keyboard, monitor and mouse can all be hot plugged. When hot plugging the mouse:

You may unplug the mouse and plug it back in again (to reset the mouse, for example), as long as you use the same mouse.

If you plug in a different mouse, all the stations and all the computers on the installation must be shut down for 10 seconds, then restarted following the power up sequence.

Notes:

- *Some older operating systems may not support hot plugging.*
- *If after hot plugging (or at any other time), there is no response to keyboard and/or mouse input, perform a keyboard and mouse reset. See **7.3.6 Computer Keyboard / Mouse Reset** for details.*

6. KVM Operation

6.5 Powering Off and Restarting

If it becomes necessary to power off the unit or if the switch loses power and needs to be restarted, follow these steps:

1. Shut down all connected computers.

Note: You must unplug the power cords of any computers that have the Keyboard Power On function.

2. Wait 10 seconds, then power the unit back on. If you have shut down more than one station, power up the highest station first and work your way down to the lowest one. Wait for each station to display its Station ID on the front panel LED before powering on the next one.
3. After the station(s) is (are) up, power on the computers once again.

6.6 Port ID Numbering

Each computer on the installation is assigned a unique Port ID. The Port ID is a one or two segment number that is determined by the stage level and KVM port number of the KVM switch that the computer is connected to.

The first segment represents the KVM port number of the first stage unit; the second segment represents the KVM port number of the second stage unit.

A computer attached to a first stage unit has a one segment Port ID (from 1- 16) that corresponds to the KVM port number that it is connected to.

A computer attached to a second stage unit has a two segment Port ID:

- The second segment (from 1-16), represents the KVM port number on the second stage unit that the computer is connected to. The first segment (from 1-16) represents the KVM port number on the first stage unit that the second stage unit links back to.
- For example, a port ID of 12-3 refers to a computer that is connected to KVM Port 3 of a second stage unit that links back to KVM Port 12 of the first stage unit.

7. Administration

7.1 IP Address Determination

If you are an administrator logging in for the first time, you need to access the B064C-16-1-IP in order to give it an IP address that users can connect to. There are three methods to choose from. In each case, your client computer must be on the same network segment as the B064C-16-1-IP. After you have connected and logged in you can give the B064C-16-1-IP its fixed network address (see **7.9.3 Network** for more information.)

The Local Console

The easiest way to assign an IP address is from the local console.

IP Installer

For client computers running Windows, an IP address can be assigned with the *IP Installer* utility. The utility can be obtained from the *Download* area of our website. Look under *DriverISW*, and the model of your switch. After downloading the utility to your client computer, do the following:

1. Unzip the contents of *IPInstaller.zip* to a directory on your hard drive.
2. Go to the directory that you unzipped the IPInstaller program to and run *IPInstaller.exe*. A dialog box similar to the one below appears:

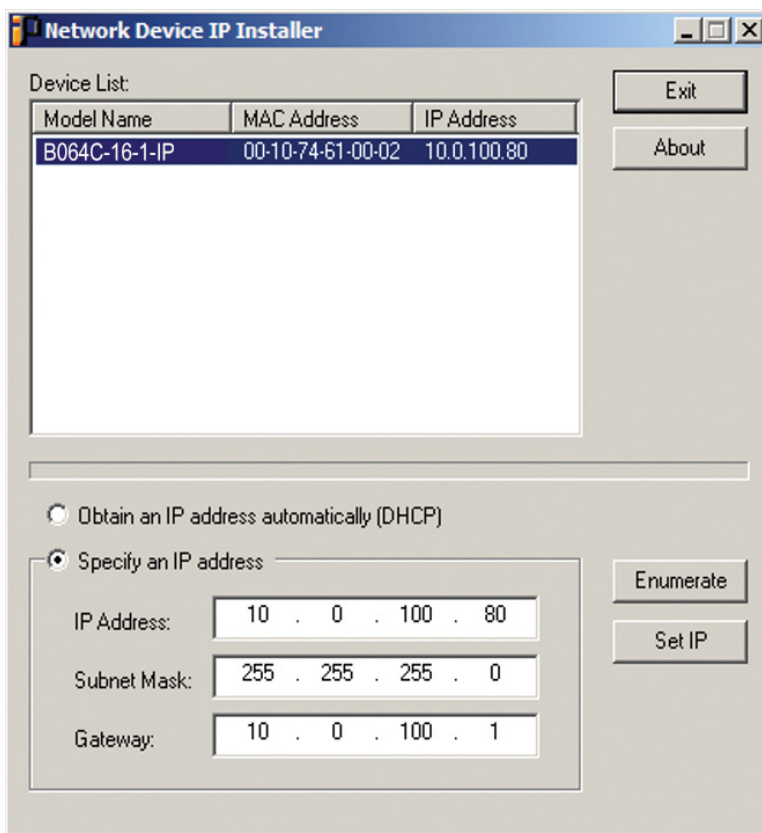

3. Select B064C-16-1-IP in the *Device List*.

Notes:

- If the list is empty, or your device does not appear, click *Enumerate* to refresh the *Device List*.
- If there is more than one device in the list, use the *MAC* address to pick the one you want.

4. Select either *Obtain an IP address automatically (DHCP)*, or *Specify an IP address*. If you chose the latter, fill the IP Address, Subnet Mask and Gateway fields with the information appropriate to your network.
5. Click **Set IP**.
6. After the IP address shows up in the *Device List*, click **Exit**.

7. Administration

Browser

1. Set your client computer's IP address to 192.168.0.XXX
Where XXX represents any number or numbers except 60 (192.168.0.60 is the default address of the B064C-16-1-IP).
2. Specify the switch's default IP address (192.168.0.60) in your browser to connect.
3. Assign a fixed IP address for the B064C-16-1-IP that is suitable for the network segment that it resides on.
After you log out, reset your client computer's IP address to its original value.

7.1.1 IPv6

The B064C-16-1-IP supports three IPv6 address protocols: *Link Local IPv6 Address*, *IPv6 Stateless Autoconfiguration* and *Stateful Autoconfiguration (DHCPv6)*.

Link Local IPv6 Address

At power on, the B064C-16-1-IP is automatically configured with a Link Local IPv6 Address (for example, fe80::210:74ff:fe61:1ef). To determine what the Link Local IPv6 Address is, log in with the B064C-16-1-IP IPv4 address and open the *Device Management* → *Device Information* page. The address is displayed in the *General* list box.

Once you have determined the IPv6 address, you can use it when logging in from a browser or the Win and Java Client AP programs.

For example:

If you are logging in from a browser, you would key:

```
http://[fe80::2001:74ff:fe6e:59%5]
```

for the URL bar.

If you are logging in with the AP program, you would key:

```
fe80::2001:74ff:fe6e:59%5
```

for the IP field of the Server panel (see 7.5.3 Windows Client AP Login).

Notes:

- To log in with the Link Local IPv6 Address, the client computer must be on the same local network segment as the B064C-16-1-IP.
- The %5 is the %interface used by the client computer. To see your client computer's IPv6 address: from the command line issue the following command: `ipconfig /all`. The % value appears at the end of the IPv6 address.

IPv6 Stateless Autoconfiguration

If the B064C-16-1-IP network environment contains a device (such as a router) that supports the IPv6 Stateless Autoconfiguration function, the B064C-16-1-IP can obtain its prefix information from that device to generate its IPv6 address. For example: 2001::74ff:fe6e:59.

As above, the address is displayed in the *General* list box of the *Device Management* → *Device Information* page.

Once you have determined the IPv6 address, you can use it when logging in from a browser or the Win and Java Client AP programs.

For example:

If you are logging in from a browser, you would key:

```
http://[2001::74ff:fe6e:59]
```

for the URL bar.

If you are logging in with the AP program, you would key:

```
2001::74ff:fe6e:59
```

for the *IP* field of the Server panel (see **7.5.3 Windows Client AP Login**).

7. Administration

7.1.2 Trusted Certificates

When you try to login to the B064C-16-1-IP from your Web browser, a Security Alert message will appear to inform you the device's certificate is not trusted and ask if you want to proceed.



The certificate can be trusted, but the alert is triggered because the certificate's name is not found on Microsoft's list of Trusted Authorities. You have two options: 1) Ignore the warning and click **Yes** to proceed; or 2) Install the certificate and have it be recognized as trusted.

- If you are working on a computer at another location, accept the certificate for just this session by clicking **Yes**.
- If you are working at your own computer, install the certificate on your computer (see below for details). After the certificate is installed, it will be recognized as trusted.

Installing the Certificate

To install the certificate:

1. In the Security Alert dialog box, click **View Certificate**. The Certificate dialog box will appear.
Note: There is a red and white X logo over the certificate to indicate it is not trusted.
2. Click **Install Certificate**.
3. Follow the Installation Wizard instructions to complete the installation. Unless you have a specific reason to choose otherwise, accept the default options.
4. The Wizard will present a caution screen. Click **Yes**.
5. Click **Finish** to complete the installation.
6. Click **OK** to close the dialog box.

7. Administration

Certificate Trusted

The certificate is now trusted:



When you click **View Certificate**, you can see the red and white **X** logo is no longer present to indicate the certificate is trusted.

7.1.3 Self-Signed Private Certificates

If you wish to create your own self-signed encryption key and certificate, a free utility (*openssl.exe*) is available for download at www.openssl.org. To create your private key and certificate:

1. Go to the directory where you downloaded and extracted *openssl.exe*.
2. Run *openssl.exe* with the following parameters:

```
openssl req -new -newkey rsa:1024 -days 3653 -nodes -x509  
-keyout CA.key -out CA.cer -config openssl.cnf
```

Notes:

- The command should be entered all on one line (i.e., do not press [Enter] until all the parameters have been keyed in).
- If there are spaces in the input, surround the entry in quotes (e.g., "Eaton Corporation").

To avoid having to input information during key generation the following additional parameters can be used: **/C /ST /L /O /OU /CN /emailAddress**.

Example

```
openssl req -new -newkey rsa:1024 -days 3653 -nodes -x509  
-keyout CA.key -out CA.cer -config openssl.cnf -subj  
/C=yourcountry/ST=yourstateorprovince/L=yourlocationor city/  
O=yourorganization/OU=yourorganizationalunit/ CN=yourcommonname/  
emailAddress=name@yourcompany.com
```

Importing Files

Once the *openssl.exe* program completes, two files - *CA.key* (the private key) and *CA.cer* (the self-signed SSL certificate) - are created in the directory that you ran the program from. These are the files that you upload in the *Private Certificate* panel of the Security page.

7. Administration

7.2 OSD Operation

7.2.1 OSD Overview

The On Screen Display (OSD) is a menu-driven method to handle computer control and switching operations. All procedures start from the OSD main screen. To display the main screen, press the dedicated invocation key KVM OSD  provided on the keyboard module.

OSD Login

The OSD incorporates a two-level (administrator / user) password system. Before the OSD main screen opens, a login dialog box appears that asks for a username and password. You must provide a valid username and password to continue.

The first time the OSD is accessed, you must use the default username and password: *administrator* and *password*. For security purposes, we strongly recommend changing these to something unique.

After logging in with the default username and password, the OSD main screen opens in Administrator mode. In this mode, you have administrator privileges, with access to all administrator and user functions, and can set up operations (including password authorization for the future).

OSD Hotkey

The OSD Hotkey is enabled to *[Scroll Lock] [Scroll Lock]* by default. Using the OSD hotkey, users can access the OSD, on the LCD or an external console while also displaying any port on the unit.

Note: To adjust the OSD hotkey settings, see **7.3.9 Setting the OSD Hotkey Combination** for details.

7.2.2 OSD Main Screen

When you invoke the OSD, a screen similar to the one below appears:

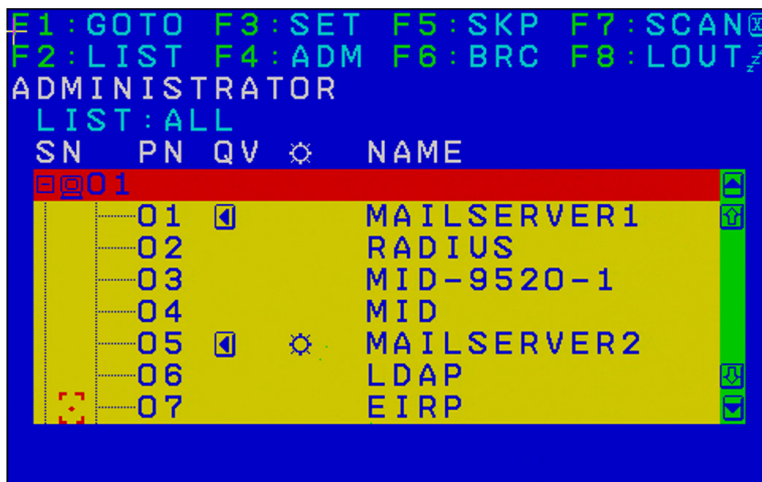

Note: The diagram depicts the Administrator's Main Screen. The User Main Screen does not show the F4 and F6 functions, as these are reserved for the administrator and cannot be accessed by ordinary users.

7. Administration

7.2.3 OSD Navigation

- To dismiss the menu and deactivate the OSD, click the X at the upper right corner of the OSD Window or press Esc.
- To Logout, click F8 or the **zZ** symbol at the top of the Main Screen or press [F8].
- The OSD uses a tree view. To see the ports for a particular station, click the plus sign [+] in front of the station number. The port number list drops down. To dismiss the list, click the circle symbol [o] in front of the station number.
- To move up or down through the list one line at a time, click the up and down triangle symbols (▲▼) or use the up and down arrow keys. If there are more list entries than there is room for on the Main Screen, the screen will scroll.
- To move up or down through the list one screen at a time, click the up and down arrow symbols (↑↓), or use the [Pg Up] and [Pg Dn] keys. If there are more list entries than there is room for on the Main Screen, the screen will scroll.
- To bring the KVM focus to a port, double-click or move the highlight bar and press [Enter].
- After executing any action, you automatically go back to the menu one level above.

7.2.4 OSD Main Screen Headings

Heading	Explanation
SN-PN	This column lists the port ID numbers (station number-port number) for all the KVM ports on the installation. The simplest method to access a particular computer is to click it or move the highlight bar to it and press [Enter].
QV	If a port has been selected for Quick View scanning, an arrowhead displays in this column.
	Computers that are powered on and are online have a sun symbol in this column.
NAME	If a port has been given a name, its name appears in this column.

7.2.5 OSD Functions

OSD functions are used to configure and control the OSD. For example, you can rapidly switch to any port, scan selected ports only, limit the list you wish to view, designate a port as a Quick View Port, create or edit a port name or make OSD setting adjustments.

To access an OSD function:

1. Click a function key field at the top of the Main Screen or press a function key on the keyboard.
2. In the submenus that appear, make your choice by double clicking or moving the highlight bar to it and pressing [Enter].
3. Press [Esc] to return to the previous menu level.

F1: GOTO

Accessing the GOTO function allows you to switch directly to a port either by keying in the port's name or its port ID.

- To use the Name method, key in "1", key in the port's name, then press [Enter].
- To use the Port ID method, key in "2", key in the port ID, then press [Enter].

Note: You can key in a partial name or port ID. The screen will show all the computers that the user has View rights to that match the name or port ID pattern, regardless of the current List settings (see F2: List for details).

To return to the OSD Main Menu without making a choice, press [Esc].

7. Administration

F2: LIST

Many of the switch's OSD functions only operate on the computers currently selected for listing on the Main Screen. Accessing this function lets you broaden or narrow the scope of ports that get listed. The submenu choices and their meanings are provided in the table below:

Choice	Meaning
ALL	Lists all ports on the installation.
QUICK VIEW	Lists only the ports that have been selected as Quick View Ports.
POWERED ON	Lists only the ports that have attached computers Powered On.
QUICK VIEW + POWERED ON	Lists only the ports that have been selected as Quick View Ports, and that have their attached computers Powered On.

Move the highlight bar to the choice you want, then press [Enter]. An icon will appear before the choice to indicate that it is the currently selected one.

F3: SET

Accessing this function allows the administrator and each user to set up an individual working environment. A separate profile for each operator is stored by the OSD and is activated according to the username provided during login.

To change a setting:

1. Double-click or move the highlight bar to it, then press [Enter].
2. After you select an item, a submenu with further choices appears. To make a selection, either double click or move the highlight bar to it, then press [Enter]. An icon appears before the selected choice to indicate which one it is. The settings are explained in the following table:

Setting	Function
OSD HOTKEY	Selects which hotkey activates the OSD function: [Scroll Lock] [Scroll Lock]; [Ctrl] [Ctrl] or [Alt] [Alt], or Off. Since the [Ctrl] or [Alt] key combinations may conflict with programs running on the computers, the default is the [Scroll Lock] combination.
PORT ID DISPLAY POSITION	Allows you to position where the port ID appears on the monitor. The default is the upper left corner, but you can choose to have it appear anywhere on the screen. Use the mouse or the arrow keys plus Pg Up, Pg Dn, Home, End, and 5 (on the numeric keypad with Num Lock off) to position the port ID display. Then click or press [Enter] to lock the position and return to the Set submenu. Note: The setting affects the currently selected port. If you do not want to use the default position, you must change the setting for each port individually.
PORT ID DISPLAY DURATION	Determines how long a port ID displays on the monitor after a port change has taken place. There are two choices: 3 seconds and Off .
PORT ID DISPLAY MODE	Selects how the port ID is displayed: the port number alone (PORT NUMBER); the port name alone (PORT NAME); or the port number plus the port name (PORT NUMBER + PORT NAME). The default is (PORT NUMBER + PORT NAME).
SCAN DURATION	Determines how long the focus dwells on each port as it cycles through the selected ports in Auto Scan mode (see F1: SCAN). Key in a value from 1-255 seconds, then press [Enter] . Default is 5 seconds; a setting of 0 disables the Scan function.

7. Administration

Setting	Function
SCAN/SKIP MODE	<p>Selects which computers will be accessed under Skip mode (see F5: SKP), and Auto Scan mode (see F1: SCAN).</p> <p>The choices are:</p> <p>ALL - All the ports which have been set Accessible.</p> <p>POWERED ON - Only those ports which have been set Accessible and are Powered On.</p> <p>QUICK VIEW + POWERED ON - Only those ports which have been set Accessible and have been selected as Quick View Ports and are Powered On. The default is ALL..</p>
SCREEN BLANKER	<p>If there is no input from the console for the amount of time set with this function, the screen is blanked. Key in a value from 1-30 minutes, then press [Enter]. A setting of 0 disables this function. The default is Off.</p>
HOTKEY COMMAND MODE	<p>Enables / Disables the Hotkey function (see 7.2 OSD Operation) in case a conflict with programs running on the computers occurs. The default is On.</p>
HOTKEY	<p>This setting selects the Hotkey invocation keys (see 7.3 Hotkey Operation). Choices are [NUM LOCK] + [-], or [CTRL] + [F12]. The default is [NUM LOCK] + [-].</p>
OSD LANGUAGE	<p>Sets the language that the OSD displays in. Choices are: English, German, Japanese, Simplified Chinese, Traditional Chinese, Spanish, Russian and French. The default is English.</p>
SET CONSOLE KEYBOARD	<p>Sets the keyboard language mapping of the console keyboard. The default is Auto. If the switch does not automatically receive language mapping from the keyboard, it will set to English (US).</p>
SET LOGOUT TIMEOUT	<p>If there is no input from the console for the amount of time set with this function, the operator is automatically logged out. A login is necessary before the console can be used again.</p> <p>This enables other operators to gain access to the computers when the original operator is no longer accessing them but has forgotten to log out. To set the timeout value, key in a number from 1-180 minutes, then press [Enter]. If the number is 0 (zero), this function is disabled. Default is Off.</p>
ACTIVATE BEEPER	<p>Choices are Y (for Yes), or N (for No). When activated, the beeper sounds whenever a port is changed when activating the Auto Scan function (see F1: SCAN) or an invalid entry is made on an OSD menu. The default is On.</p>
PREFERRED RESOLUTION	<p>This function allows you to set the preferred resolution for a second external display connected to the switches console port, which will be sent by way of the KVM adapter cables. The KVM adapter cables provide the connected computer's video card with EDID information about the monitor connected to the switch. This affects the video quality displaying on the external console monitor. Choices are:</p> <ul style="list-style-type: none"> • MONITOR DEFAULT SETTING - Sends the EDID information provided by the switch's LCD monitor to the KVM adapter cable. • Alternative Resolution - Sends the alternative resolution (EDID information) selected for the external display connected to the switches console port to the KVM adapter cables. Select a resolution that best suits the video display for the monitor connected to the switches console port. <p>Note: When using the built-in LCD monitor, the default resolution must be set to 1280 x 1024 60 Hz. Only change the preferred resolution when connecting an external display to the console monitor port.</p>
TOUCHPAD	<p>Enables / Disables the touchpad function of the console. Choices are Y (for Yes), or N (for No). The active status (Touchpad On / Touchpad Off) is also shown.</p>

7. Administration

F4: ADM

F4 is an administrator-only function. Accessing this function allows the administrator to configure and control the overall operation of the OSD. To change a setting, double-click it or use the up and down arrow keys to move the highlight bar to it, then press **[Enter]**.

After you select an item, a submenu with further choices appears. Double click the choice you want or move the highlight bar to it, then press **[Enter]**. An icon appears before the selected choice.

Setting	Function
SET IP ADDRESS	<p>This function is used to select whether to assign the IP address automatically (DHCP) or to give it a fixed IP address.</p> <ul style="list-style-type: none"> • Enable DHCP to assign the IP address automatically. • Disable DHCP to assign a fixed IP address and specify the IP, Mask, and Gateway in the appropriate fields. <p>Note: <i>The default setting for DHCP is disabled.</i></p>
EDIT PORT NAMES	<p>To identify which computer is attached to a particular port, every port can be assigned a name. This function allows the administrator to create, modify or delete port names. To assign a port name:</p> <ol style="list-style-type: none"> 1. Click the port you want or use the navigation keys to move the highlight bar to it, then press [Enter]. 2. Key in the new port name or modify/delete the old one. The maximum number of characters allowed for the port name is 14. Legal characters include: <ul style="list-style-type: none"> • All alpha characters: A-Z* • All numeric characters: 0-9 <p>* You can enter the port names in either upper or lower case. However, the OSD displays the port name only in UPPERCASE.</p> 3. When you have finished editing, press [Enter] to have the change take effect. To abort the change, press [Esc].
RESTORE DEFAULT VALUES	<p>This function is used to undo all changes and return the setup to the original factory default settings (see 8.11 OSD Factory Default Settings for details) except for the <i>Names</i> settings that were assigned to the ports, which are saved.</p>
CLEAR THE NAME LIST	<p>This function clears the port name list.</p>
RESET STATION IDS	<p>If you change the position of one of the stations in the daisy chain, the OSD settings will no longer correspond to the new situation. This function directs the OSD to rescan the station positions of the entire installation and updates the OSD so that the OSD station information corresponds to the new physical layout.</p> <p>Note: <i>Only the station numbers get updated. Except for the port names, all administrator settings for all of the computers affected by the change have to be reentered manually.</i></p>
SET OPERATING SYSTEM	<p>Specifies the operating platform of the computer attached to each port. You must configure each port on the installation. For each port, press the [Spacebar] to cycle through the choices (PC, Mac or Sun). Repeat until all the ports have been set, then press [Esc]. The default is PC.</p> <p>Note: <i>If you are installing a Sun or Mac computer, it may not boot when you run it for the first time unless you first set the correct operating system for the port it is connected to.</i></p>
SET CAT 5 LENGTH	<p>Lets you specify how long the Cat 5e/6 cable between the port and the KVM adapter cable is. Press [Spacebar] to cycle through the cable length settings:</p> <p>S: Short - up to 82 ft. (25 m) M: Medium - between 65 and 115 ft. (20 and 35 m) L: Long - above 115 ft. (35 m)</p> <p>An S, M, or L appears next to the port to indicate the choice.</p>

7. Administration

Setting	Function
SET KEYBOARD LANGUAGE	Sets the keyboard language layout for the computers attached to each port. Press [Spacebar] to cycle through the choices: The default is English (US).
FIRMWARE UPGRADE	In order to upgrade the B064C-16-1-IP and adapter cable firmware, you must first enable <i>Firmware Upgrade</i> mode with this setting. When you access this menu, the current firmware version of the KVM switch and the iCard will be displayed. Select Y to enable Firmware Upgrade mode, or N to leave this menu without enabling it.
ADAPTER UPGRADE	This function allows the administrator to check the firmware version of the KVM adapter cable. When you access this menu, the current firmware version levels display.
SET CONSOLE MODE	This setting selects which console(s) (internal/external) are enabled: 0: Both Consoles enabled 1: LCD Console only 2: External console only Use the spacebar to cycle through the choices. The default is 0. Changes will not be saved until you logout.
SET VIDEO HV MODE	This setting selects the video mode (separate or composite video sync signals) the port(s) (internal/external) is using. Press [Spacebar] to enter this setting and see a list of ports. Use the [Spacebar] to cycle through the choices. The choices are: S: Separate (default) C: Composite Changes will not be saved until you exit to the main menu. Note: <i>If your dongle does not support video HV mode, the unit will emit a beeping sound whenever you cycle through the choices.</i>

F5: SKP

This function enables you to skip backward or forward easily, switching the console focus from the currently active KVM Port to the previous or next available one.

- The selection of computers to be available for Skip mode switching is made with the *ScanISkip* mode setting under the F3 SET function.
- When in Skip mode, press:
 - ← To skip to the previous port in the list.
 - To skip to the next port in the list.
 - ↑ To skip to the last port of the previous station in the list.
 - ↓ To skip to the first port of the next station in the list.

Note: *When you skip, you may only skip to the previous or next available computer that is in the ScanISkip mode selection.*

- If a port has been selected for *ScanISkip* mode, the focus switches to that port a left/right triangle symbol appears before its port ID display.
- While *Skip* mode is in effect, the console will not function normally. You must exit *Skip* mode to regain control of the console.
- To exit *Skip* mode, press the **[Spacebar]** or **[Esc]**.

7. Administration

F6: BRC

F6 is an administrator-only function. When this function is in effect, commands sent from the console are broadcast to all available computers on the installation.

This function is particularly useful for operations that need to be performed on multiple computers, such as performing a system wide shutdown, installing or upgrading software, etc.

- While *BRC* mode is in effect, a speaker symbol appears before the port ID display of the port that currently has the console focus.
- While *BRC* mode is in effect, the mouse will not function normally. You must exit BRC mode to regain control of the mouse.
- To exit *BRC* mode, invoke the OSD (with the OSD Hotkey), then click the **F6** field or press **[F6]** to turn BRC mode off.

F7: SCAN

This function automatically switches among the available computers at regular intervals so you can monitor their activity without switching manually.

- The selection of computers to be included for Auto Scanning is made with the *Scan/Skip* mode setting under the **F3 SET** function.
- The amount of time that each port displays for is set with the *Scan Duration* setting under the **F3 SET** function.
- As each computer is accessed, an S appears in front of the port ID display to indicate it is being accessed under *Auto Scan* mode.
- While you are in Auto Scan mode, you can pause scanning and keep the focus on a particular computer by pressing **P** or with a left-click of the mouse. To resume scanning, press any key or left-click again (see **7.3.4 Auto Scan Mode Switching** for details).
- While *Auto Scan* mode is in effect, the console will not function normally. You must exit Auto Scan mode to regain control of the console.
- To exit *Auto Scan* mode, press the **[Spacebar]** or **[Esc]**.

F8: LOUT

Clicking the **F8** field or pressing **[F8]** logs you out of the OSD and blanks the console screen. This is different from simply deactivating the OSD when you are at the Main Screen by pressing **[Esc]**.

With this function, you must log in all over again to regain access to the OSD, whereas with **[Esc]**, simply press the OSD Hotkey to reenter the OSD.

Notes:

- *When you reenter the OSD after logging out, the screen stays blank except for the login dialog box. You must input your username and password before you can continue.*
- *If you reenter the OSD after logging out and immediately use **[Esc]** to deactivate the OSD without having selected a port from the OSD menu, a Null Port message displays on the screen. The OSD hotkey will access the OSD Main Screen.*

7. Administration

7.3 Hotkey Operation

7.3.1 Hotkey Port Control

Hotkey port control allows you to provide KVM focus to a particular computer directly from the keyboard. B064C-16-1-IP provides the following Hotkey port control features:

- Selecting the Active Port
- Auto Scan Mode Switching
- Skip Mode Switching
- Computer Keyboard / Mouse Reset

The following settings can also be controlled in Hotkey mode:

- Setting the Beeper
- Setting the Quick Hotkey
- Setting the OSD Hotkey
- Setting the Port Operating System
- Restoring the OSD Default Values

7.3.2 Invoking Hotkey Mode

All Hotkey operations begin by invoking *Hotkey* mode. To invoke Hotkey mode, you may use two possible keystroke sequences shown below. Only one of the two key-sequences below can be operational (see **Setting the Hotkey key combination** for details):

Number Lock and Minus Keys

1. Hold down the **[Num Lock]** key
2. Press and release the **[Minus]** key
3. Release the **[Num Lock]** key **[Num Lock] + [-]**

Control and F12 Keys

1. Hold down the **[Ctrl]** key
2. Press and release the **[F12]** key
3. Release the **[Ctrl]** key **[Ctrl] + [F12]**

Hotkey Mode Environment

When *Hotkey* mode is active:

- A command line appears on the monitor screen. The command line prompt is the word *Hotkey:* in white text on a blue background, and displays the subsequent Hotkey information that you key in.
- Ordinary keyboard and mouse functions are suspended - only Hotkey-compliant keystrokes (described in the sections that follow), can be input.

Exiting Hotkey Mode

Pressing **[Esc]** exits *Hotkey* mode.

7. Administration

7.3.3 Selecting the Active Port

Each computer port is assigned a port ID (see **6.6 Port ID Numbering**). You can directly access any computer with a Hotkey combination that specifies the port ID that the computer is connected to. The steps are:

1. Enter the *Hotkey* mode with the:
[Num Lock] + [-] or **[Ctrl] + [F12]** combination.
2. Key in the port ID.
The port ID numbers display on the command line as you key them in. If you make a mistake, use **[Backspace]** to erase it.
3. Press **[Enter]**.
After you press **[Enter]**, the KVM focus switches to the designated computer and will automatically exit *Hotkey* mode.

Note: In *Hotkey* mode, the KVM focus will not switch to a port if an invalid switch or port number is entered. The *Hotkey* command line will continue to display on the screen until you enter a valid switch and port number combination or exit *Hotkey* mode.

7.3.4 Auto Scan Mode Switching

Auto Scan automatically switches among all the active computer ports that are accessible to the current logged-on user at regular intervals. This allows their activity to be monitored automatically (See **SCAN/SKIP MODE** of the **OSD F3 SET** function).

Setting the Scan Interval

The amount of time *Auto Scan* keeps the focus on each port is set with the *SCAN DURATION* setting of the OSD F3 SET function. You can change the scan interval before you activate Hotkey Auto Scanning by entering the following Hotkey combination:

1. Enter the Hotkey mode:
[Num Lock] + [-] or **[Ctrl] + [F12]** combination.
2. Key in **[A][n]**
Where **[A]** is the letter A, and **[n]** is a number from 1-255 that represents the length of the focus time in seconds.
The letter A and the numbers display on the command line as you key them in. Use **[Backspace]** to erase any wrong entry.
3. Press **[Enter]**
After you press **[Enter]**, exit Hotkey mode and start Auto Scanning.

Entering Auto Scan

To enter the *Auto Scanning* mode, key in the following Hotkey combination:

1. Enter the Hotkey mode:
[Num Lock] + [-] or **[Ctrl] + [F12]** combination.
2. Press **[A] + [Enter]**.
 - While you are in Auto Scan mode, you can pause the scanning to keep the focus on a particular computer by pressing [P]. When Auto Scanning is paused, the Command Line displays: *Auto Scan: Paused*.

When you want to keep the focus on a particular computer, *Pausing* is more convenient than exiting *Auto Scan* mode. When you resume scanning it starts at the computer where you paused. If you exited and then restarted Auto Scanning, it starts, at the beginning, from the first computer on the installation.

To resume Auto Scanning, press any key. Scanning continues from the computer you paused at.

- While the *Auto Scan* mode is operating, ordinary keyboard and mouse functions are suspended - only *Auto Scan* mode compliant keystrokes can be input. You must exit Auto Scan mode to regain normal control of the console.

Exiting Auto Scan

1. To exit *Auto Scan* mode, press **[Esc]** or **[Spacebar]**. Auto Scanning stops when you exit *Auto Scan* mode.

7. Administration

7.3.5 Skip Mode Switching

This feature allows you to switch between computers to monitor them manually. You can focus on a particular port for as long as you like (as opposed to auto-scanning, which automatically switches the port focus after a fixed interval).

Entering Skip Mode

To enter *Skip* mode, key in the following Hotkey combination:

1. Enter the *Hotkey* mode by pressing the:

[Num Lock] + [-] or **[Ctrl] + [F12]** combination.

2. Press one of the **[Arrow]** keys.

After you press one of the keyboard arrows, you automatically exit *Hotkey* mode and enter *Skip* mode where you can switch ports as follows:

←	Skips to the first accessible port.
→	Skips to the next accessible port.
↑	Skips to the last accessible port of the previous station.
↓	Skips to the first accessible port of the next station.

Once you are in *Skip* mode, you can continue skipping by pressing the arrow keys. You do not have to use the **[Num Lock] + [-]** combination again.

While *Skip* mode is in effect, ordinary keyboard and mouse functions are suspended - only *Skip* mode compliant keystrokes can be input. You must exit *Skip* mode to regain normal control of the console.

Exiting Skip Mode

1. To exit *Skip* mode, press **[Esc]** or **[Spacebar]**.

7.3.6 Computer Keyboard / Mouse Reset

If either the keyboard or mouse stop functioning on the computer connected to the currently selected port, you can perform a keyboard / mouse reset on the computer by performing the following steps:

1. Enter the *Hotkey* mode with the:

[Num Lock] + [-] or **[Ctrl] + [F12]** combination.

2. Press **[F5]**.

After you press **[F5]** you automatically exit *Hotkey* mode and regain keyboard and mouse control on the computer connected to the KVM port. If you fail to regain keyboard / mouse control on the computer after pressing **[F5]**, perform a system reset.

This function is essentially the same as unplugging and replugging the keyboard and mouse on the target computer.

7.3.7 Setting the Hotkey Beeper ON / OFF

The beeper can be turned on and off with Hotkeys performing by the following steps:

1. Enter the *Hotkey* mode with the:

[Num Lock] + [-] or **[Ctrl] + [F12]** combination.

2. Press **[B]**.

After you press **[B]**, the beeper turns on or off. The command line displays *Beeper On* or *Beeper Off* for one second, then the message will disappear and you will automatically exit *Hotkey* mode.

7. Administration

7.3.8 Setting the Hotkey Key-Combination

The keys used to enter Hotkey mode can be switched between:

[Num Lock] + [-], and **[Ctrl] + [F12]** by the following steps:

1. Enter the *Hotkey* mode with the:

[Num Lock] + [-] or **[Ctrl] + [F12]** combination.

2. Press **[H]**.

After you press **[H]**, the command line displays *HOTKEY HAS BEEN CHANGED* for one second, then the message will disappear and you will automatically exit Hotkey mode.

7.3.9 Setting the OSD Hotkey Combination

The Hotkeys used to access the OSD (see **7.3.9 Setting the OSD Hotkey Combination**) can be switched between **[Scroll Lock]**, **[Scroll Lock]**, **[Ctrl]**, **[Ctrl]** and **[Alt]**, **[Alt]** by the following steps:

1. Enter the *Hotkey* mode with the:

[Num Lock] + [-] or **[Ctrl] + [F12]** combination.

2. Press **[T]**.

After you press **[T]**, the command line displays *HOTKEY HAS BEEN CHANGED* for one second, then the message will disappear and you will automatically exit *Hotkey* mode.

7.3.10 Setting the Port Operating System

A port's operating system configuration can be matched to that of the computer attached to the port by performing the following steps:

1. Enter the *Hotkey* mode with the:

[Num Lock] + [-] or **[Ctrl] + [F12]** combination.

2. Press a **[Function]** key, where **[Function]** refers to one of the function keys in the following table:

Key	Description
F1	Sets the Port OS to Windows
F2	Sets the Port OS to Mac
F3	Sets the Port OS to Sun

After pressing a function key, you automatically exit *Hotkey* mode.

7.3.11 Restore the Default Values

This administrator-only Hotkey restores the default values by performing the following steps:

1. Enter the *Hotkey* mode with the:

[Num Lock] + [-] or **[Ctrl] + [F12]** combination.

2. Press **[R]**.

3. Press **[Enter]**.

After you press **[Enter]**, the command line displays *RESET TO DEFAULT SETTING* for three seconds, then the message will disappear and you will automatically exit *Hotkey* mode.

7. Administration

7.3.12 Hotkey Summary Table









[Num Lock] + [-] or [Ctrl] + [F12]	[A] [Enter]	Invokes Auto Scan mode. When Auto Scan mode is in effect, [P] or left-click pauses auto-scanning. When auto-scanning is paused, pressing any key or another left-click resumes auto-scanning.
	[B]	Toggles the Beeper On or Off.
	[Esc] or [Spacebar]	Exits Hotkey mode.
	[F1]	Sets Operating System to Windows.
	[F2]	Sets Operating System to Mac.
	[F3]	Sets Operating System to Sun.
	[H]	Toggles the Hotkey invocation keys.
	[Port ID] [Enter]	Switches access to the computer that corresponds to that Port ID.
	[R] [Enter]	Administrator-only hotkey. It returns the switch's settings to their default values.
	[T]	Toggles the OSD Hotkey between [Ctrl] [Ctrl] and [Scroll Lock] [Scroll Lock].
	[←]	Invokes Skip mode and skips from the current port to the first accessible port previous to it.
	[→]	Invokes Skip mode and skips from the current port to the next accessible port.
	[↑]	Invokes Skip mode and skips from the current port to the last accessible port of the previous station.
[↓]	Invokes Skip mode and skips from the current port to the first accessible port of the next station.	

7. Administration

7.4 Keyboard Emulation

7.4.1 Mac Keyboard

The PC compatible (101/104 key) keyboard can emulate the functions of the Mac keyboard. The emulation mappings are listed in the table below:







PC Keyboard	Mac Keyboard
[Shift]	Shift
[Ctrl]	Ctrl
	
[Ctrl] [1]	
[Ctrl] [2]	
[Ctrl] [3]	
[Ctrl] [4]	
[Alt]	Alt
[Print Screen]	F13
[Scroll Lock]	F14
	U
[Enter]	Return
[Backspace]	Delete
[Insert]	Help
[Ctrl] 	F15

Note: When using key combinations, press and release the first key (Ctrl), then press and release the activation key.

7. Administration

7.4.2 Sun Keyboard

The PC compatible (101/104 key) keyboard can emulate the functions of the Sun keyboard when the Control key [Ctrl] is used in conjunction with other keys. The corresponding functions are shown in the table below:

PC Keyboard	Sun Keyboard
[Ctrl] [T]	Stop
[Ctrl] [F2]	Again
[Ctrl] [F3]	Props
[Ctrl] [F4]	Undo
[Ctrl] [F5]	Front
[Ctrl] [F6]	Copy
[Ctrl] [F7]	Open
[Ctrl] [F8]	Paste
[Ctrl] [F9]	Find
[Ctrl] [F10]	Cut
[Ctrl] [1]	
[Ctrl] [2]	
[Ctrl] [3]	
[Ctrl] [4]	
[Ctrl] [H]	Help
	Compose
	

Note: When using key combinations, press and release the first key (Ctrl), then press and release the activation key.

7. Administration

7.5 Logging In

The B064C-16-1-IP can be accessed via its Graphical User Interface (GUI) locally and remotely from an Internet browser, a Windows application (AP) program and a Java application (AP) program.

No matter which access method you choose, the B064C-16-1-IP's authentication procedure requires you to submit a valid username and password. If you supply invalid login information, the authentication routine will return an *Invalid Username* or *Password*, or *Login Failed* message. If you see this message, log in again with a correct username and password.

Note: *If the number of invalid login attempts exceeds a specified amount, a timeout period is invoked. You must wait until the timeout period expires before you can attempt to log in again.*

7.5.1 Local Login

For instructions on logging in locally to your B064C-16-1-IP, refer to **7.2 OSD Operation**.

7.5.2 Browser Login

The B064C-16-1-IP can be accessed via Internet browser running on any platform. To access the switch, do the following:

1. Open the browser and specify the IP address of the switch you want to access in the browser's location bar.

Notes:

• *For security purposes, a login string may have been set by the administrator. If so, you must include a forward slash and the login string along with the IP address when you log in. For example:*

192.168.0.100/B064C161IP

• *If you do not know the IP address and login string, ask your Administrator. The default IP address is: 192.168.0.60*

2. When a *Security Alert* dialog box appears, accept the certificate (see **7.1.2 Trusted Certificates** for details.) If a second certificate appears, accept it as well.

Once you accept the certificate(s), the login page appears:

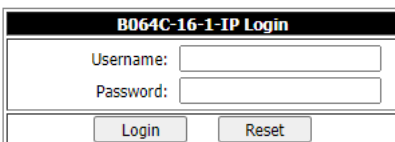

B064C-16-1-IP Login	
Username:	<input type="text"/>
Password:	<input type="password"/>
<input type="button" value="Login"/>	<input type="button" value="Reset"/>



3. Provide your username and password (set by the administrator), then click **Login** to access the Web Main Page.

Note: *If you are the administrator and logging in for the first time, use the default username: **administrator** and default password: **password**. For security purposes, the system will prompt you to change the login password. The password must be different from your login password.*

7. Administration

7.5.3 Windows Client AP Login

The Windows AP Client allows direct remote access to Windows systems users without having to go through a browser (although you initially download the Windows AP Client program from the browser page, see **7.12 Download** for more information). To connect to the B064C-16-1-IP, go to the location on your hard disk that you downloaded the Windows AP Client program and double-click its icon (*WinClient.exe*).

To connect to the B064C-16-1-IP, click the *WinClient.exe* program icon (on your desktop) to access the Windows Client Connection screen:

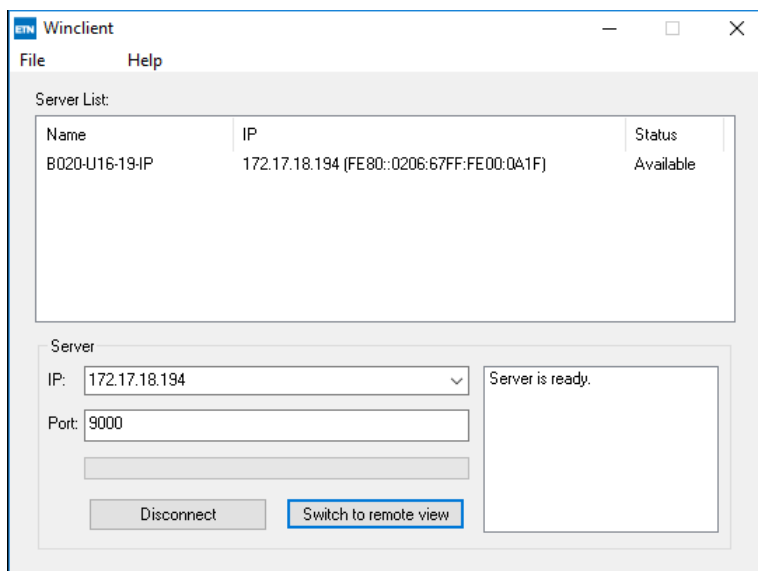

The Windows Client AP Connection Screen

Item	Description
Server List	<p>Each time the WinClient.exe file is run, it searches the user's local LAN segment for the B064C-16-1-IP and lists whichever ones it finds in this box. If you want to connect to one of these units, double-click it.</p> <p>Notes:</p> <ul style="list-style-type: none">• The switch will not appear in the list unless its Enable Device List configuration parameter has been enabled.• Only units whose Access Port settings for Program match the number specified for Port in the Server area of this dialog box appear in the Server List window.
Server	<p>This area is used when you want to connect to at a remote location. You can drop down the IP list box and select an address from the list. If the address you want is not listed, you can key in the target IP address in the IP field and its port number in the Port field. (If you do not know the port number, contact your Administrator.)</p> <ul style="list-style-type: none">• Once the IP address and Port number have been specified, click Connect.• Once you have finished with your session and return to this dialog box, click Disconnect to end the connection.
Message List	<p>Located just to the right of the Server panel, the Message List panel lists status messages regarding the connection to the B064C-16-1-IP.</p>
Connect	<p>Click Connect after selecting a device in the Server list to login with a secure connection.</p>
Switch to Remote View	<p>Once you have been authenticated, this button becomes active. Click it to switch to the GUI Main Page.</p>

7. Administration

Connecting - Windows Client AP

1. From the *Server List* box, double-click the device that you wish to connect to.

- Or -

Specify its IP address and port number in the *Server IP* and *Port* input boxes.

2. Click **Connect**.

The *Login* dialog box will appear:

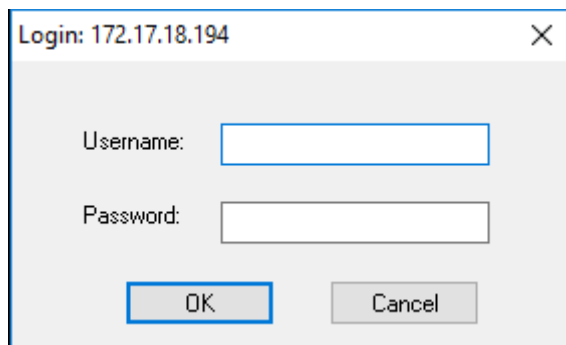

A login dialog box titled "Login: 172.17.18.194" with a close button (X) in the top right corner. It contains two input fields: "Username:" and "Password:". Below the fields are two buttons: "OK" and "Cancel".

3. Key in a valid Username and Password, then click **OK**.

4. Once you have been authenticated, the *Remote View* button becomes active:

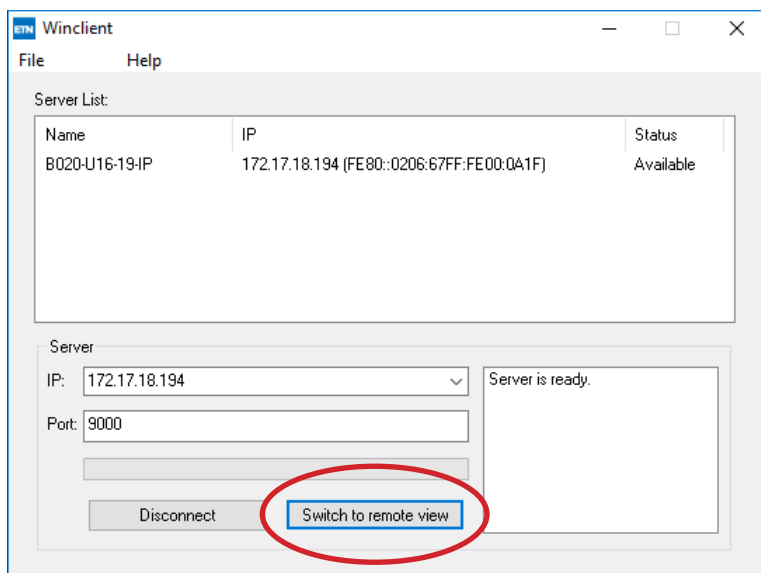

The Winclient application window shows a "Server List" table with one entry:

Name	IP	Status
B020-U16-19-IP	172.17.18.194 (FE80::0206:67FF:FE00:0A1F)	Available

Below the table, the "Server" section shows the IP address "172.17.18.194" selected in a dropdown menu, and the "Port" set to "9000". A status box on the right says "Server is ready." At the bottom, there are two buttons: "Disconnect" and "Switch to remote view". The "Switch to remote view" button is circled in red.

5. Click it to connect to the switch and access its GUI Main Page.

7. Administration

7.5.4 Java Client AP Login

The Java AP Client provides direct remote access to non-Windows systems users (although you initially download the Java AP Client program from the browser page, see **7.12 Download** for more information). To connect to the B064C-16-1-IP, go to the location on your hard disk that you downloaded the Java AP Client program to and double-click its icon (*JavaClient.jar*).

To connect to the B064C-16-1-IP, click the *JavaClient.jar* program icon (on your desktop) to access the Windows Client Connection screen:

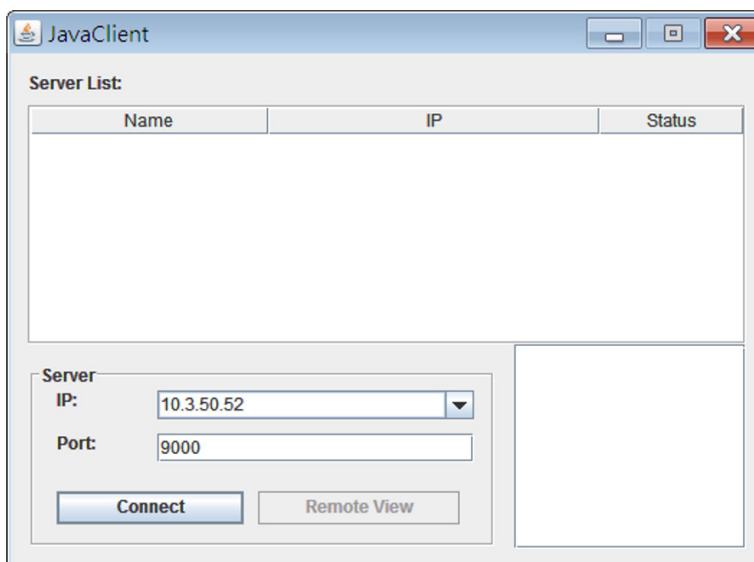

The Java Client AP Connection Screen

Item	Description
Server List	<p>Each time the JavaClient.jar file is run, it searches the User's local LAN segment for B064C-16-1-IP and lists whichever ones it finds in this box. If you want to connect to one of these units, double-click it.</p> <p>Notes:</p> <ul style="list-style-type: none">• The switch will not appear in the list unless its Enable Device List configuration parameter has been enabled.• Only units whose Access Port settings for Program match the number specified for Port in the Server area of this dialog box appear in the Server List window.
Server	<p>This area is used when you want to connect to a B064C-16-1-IP at a remote location. You can drop down the IP list box and select an address from the list. If the address you want is not listed, you can key in the target IP address in the IP field and its port number in the Port field. (If you do not know the port number, contact your Administrator.)</p> <ul style="list-style-type: none">• When the IP address and Port number have been specified, click Connect.• When you have finished with your session and return to this dialog box, click Disconnect to end the connection.
Message Panel	<p>Located just to the right of the Server panel, the Message panel lists status messages regarding connection to the B064C-16-1-IP.</p>
Connect	<p>Click Connect after selecting a device in the Server list to login with a secure connection.</p>
Switch to Remote View	<p>Once you have been authenticated, this button becomes active. Click it to switch to the GUI Main Page.</p>

7. Administration

Connecting - Java Client AP

To connect to a KVM switch, do the following:

1. From the *Server List* box, double-click the device that you wish to connect to.

- Or -

Specify its IP address and port number in the *Server IP* and *Port* input boxes.

2. Click **Login**

The *Login* dialog box appears:

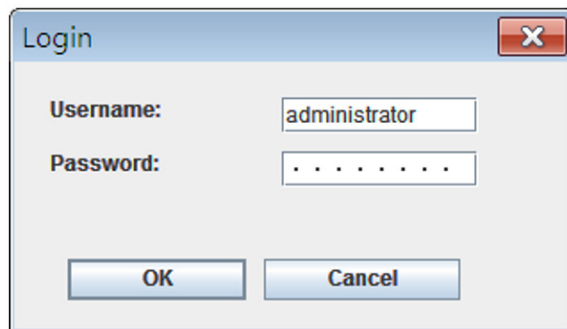

3. Key in a valid Username and Password, then click **OK**.

4. Once you have been authenticated, the *Remote View* button becomes active:

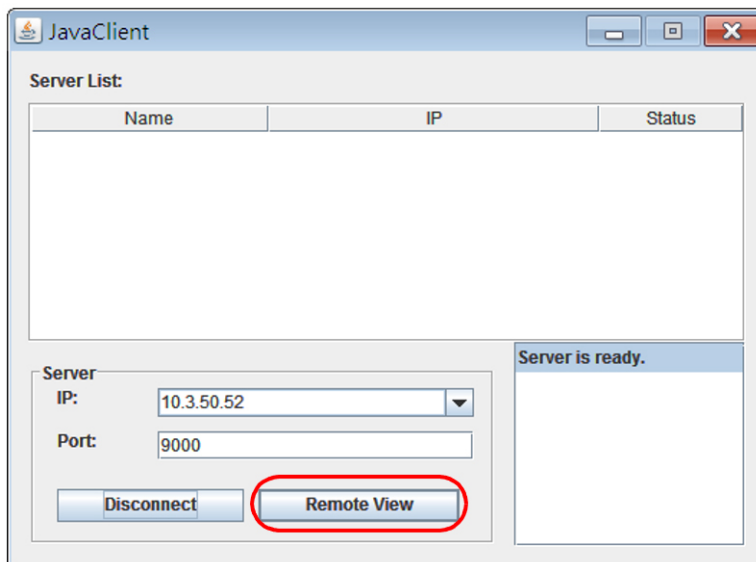

5. Click it to connect to the switch and access its GUI Main Page.

7. Administration

7.6 User Interface

Once you have successfully logged in, the B064C-16-1-IP user interface Main Page will appear. The appearance of the page may vary slightly, depending on which method was used to log in.

7.6.1 Web Browser Main Page

To ensure multi-platform operability, access to the B064C-16-1-IP can be accomplished with most standard web browsers. Once users log in and are authenticated, the *Web Browser Main Page* will appear with the Port Access page displayed:

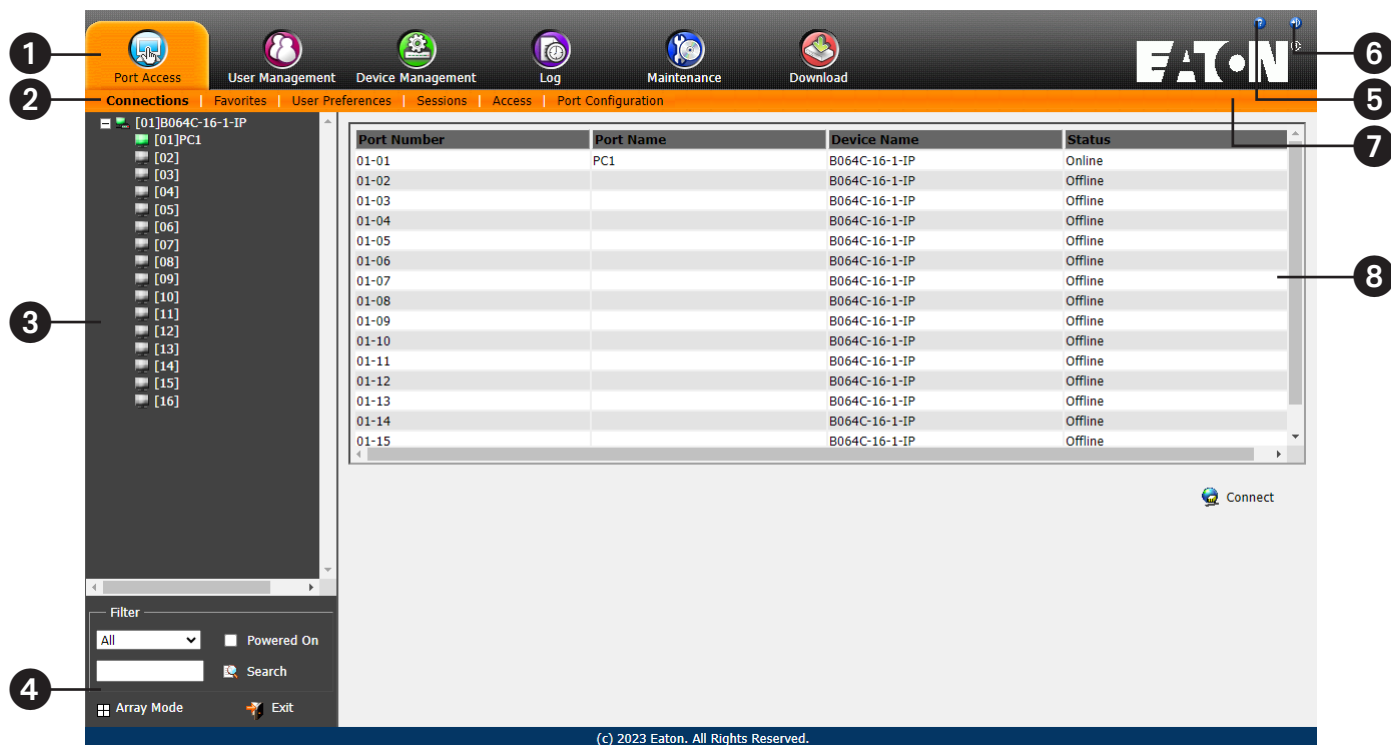

Note: The above screen shows an Administrator's page. Depending on a user's type and permissions, not all of these elements may appear.







1	Tab Bar	The tab bar contains the B064C-16-1-IP main operation categories. The items that appear in the tab bar are determined by the user's type and the authorization options that were selected when the user's account was created.
2	Menu Bar	The menu bar contains operational sub-categories that pertain to the item selected in the tab bar. The items that appear in the menu bar are determined by the user's type and the authorization options that were selected when the user's account was created.
3	Sidebar	The Sidebar provides a tree view listing of ports that relate to the various tab bar and menu bar selections. Clicking a node in the Sidebar will open a page with the details that are relevant to it.
4	Filter	The filter section at the bottom of the Sidebar lets you expand or narrow the scope of the ports that appear in the Sidebar tree: <ul style="list-style-type: none"> • All - Lists all the ports on the installation. • Power On - Lists only the ports that have their attached devices powered on. • Search - Lists only the ports that relate to the text typed in the search box. Enter text, then click Search.

7. Administration

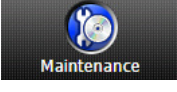

5	Help	Provides information regarding the switch's current firmware version.
6	Logout	Click this button to log out of your session.
7	Welcome Message	If this function is enabled, a welcome message displays here.
8	Interactive Display Panel	This is your main work area. The screens that appear reflect your menu choices and Sidebar node selection.

The Tab Bar

The number and type of icons that appear on the Tab Bar at the top of the page are determined by the user's type (Administrator or User) and the permissions assigned when the user's account was created.

Icon	Function
	Port Access: The Port Access page is used to access and control the devices on the B064C-16-1-IP installation. This page is available to all users.
	User Management: The User Management page is used to create and manage Users and Groups. It can also be used to assign devices to them. User Management is discussed in 7.8 User Management . This tab is available to the Administrator, as well as users who have been given User Management permission. The tab does not appear for other users.
	Device Management: The Device Management page is used to configure and control the overall operation of the B064C-16-1-IP. This page is available to the Administrator, as well as users who have been given Device Management permission. The tab does not appear for other users.
	Log: The Log page displays the contents of the log file.
	Maintenance: The Maintenance page is used to install new firmware; backup and restore configuration and account information; ping network devices; and restore default values. This page is available to the Administrator and Users with <i>Maintenance</i> permission. The icon does not display on the page of regular users.
	Download: Users can click this icon to download AP versions of the Windows Client, the Java Client and the Log Server. This page is available to all users. The programs that can be downloaded depend on the user's permissions.

There are two small icons at the extreme right of the page.

Icon	Function
	Click this icon to access a panel with information about the KVM switch firmware version.
	Click this icon to log out and end your KVM switch session.

7. Administration

7.6.2 AP GUI Main Page

With WinClient AP and Java Client AP access, once users log in (see **7.5 Logging In**), the *GUI Main Page* will open:

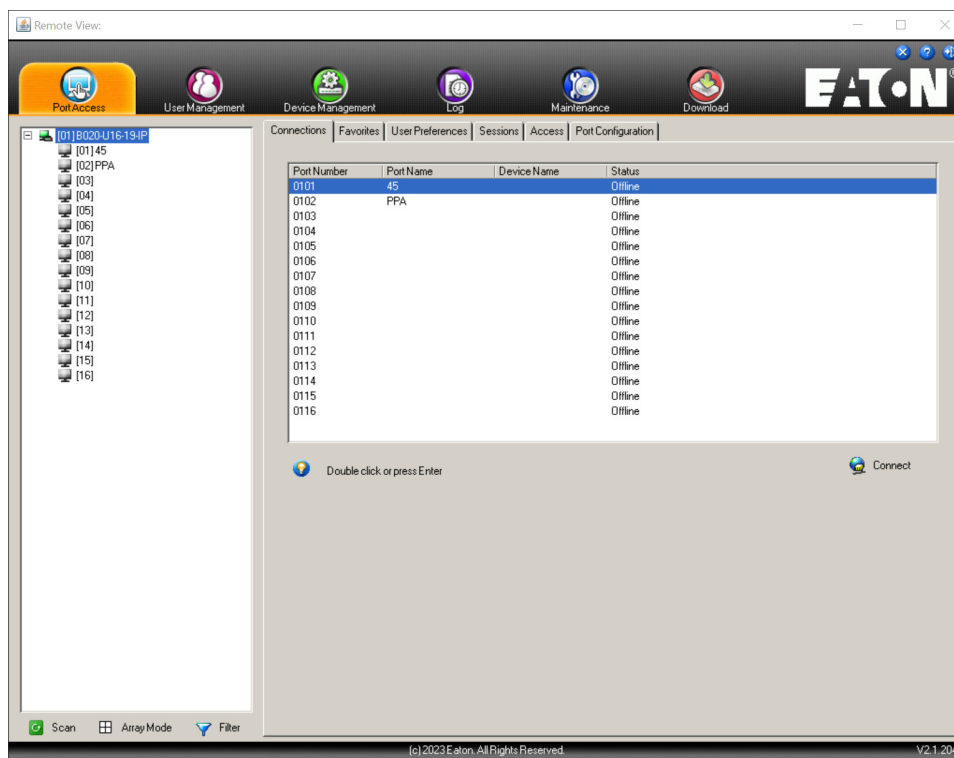

The GUI Main Page is similar to the Web Browser. The differences between them are as follows:

1. The AP GUI version does not have a menu bar below the tab bar; it instead has a series of tabs like a notebook. Like the Web Browser interface, the makeup of the tabbed notebook changes depend on the items selected on the main Tab Bar and in the Sidebar.
2. There is a hidden *Control Panel* at the upper or lower center of the screen that becomes visible when you hover your cursor over it (the default is at the upper center of the screen).

7. Administration

7.6.3 Control Panel

WinClient Control Panel

Since the WinClient Control Panel contains the most complete functionality, this section describes the WinClient Control Panel. Although the Java Control Panel does not enable all the features as the WinClient Control Panel, the functions they do share are the same and you can refer to the information described here when using it.

The Control Panel is hidden at the upper or lower center of the screen (the default is at the lower center) and will become visible when you mouse over it. The panel consists of three rows: an icon row at the top, and two text rows below it:



Note: The above image shows the complete Control Panel. The icons that appear can be user selected.



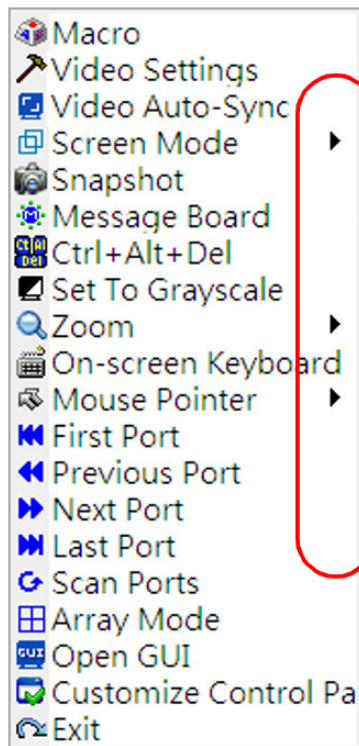

















- By default, the upper text row shows the video resolution of the remote display. As the mouse pointer moves over the icons in the icon bar, information in the upper text row changes to describe the icon's function. In addition, if a message from another user is entered in the message board and you have not opened the message board in your session, the message will appear in the upper row.
- The lower row shows the IP address of the device you are accessing at the left of the row.
- Right-clicking in the text row area opens a menu-style version of the toolbar. In addition, it allows you to select options for the *Screen Mode*, *Zoom*, *Mouse Pointer type* and *Mouse Pointer*.





- To move the Control Panel to a different location on the screen, place the mouse pointer over the text row area, then click and drag.

7. Administration

WinClient Control Panel Functions

Icon	Function
	This is a toggle. Click to make the Control Panel persistent (e.g., always display on top of other screen elements). Click again to display normally.
	Click to access the Macros dialog box.
	Click to access the Video Options dialog box. Right-click to perform a quick Auto Sync.
	Click to perform a video and mouse autosync operation. It is the same as clicking the AutoSync button in the <i>Video Options</i> dialog box.
	Toggles the display between <i>Full Screen Mode</i> and <i>Windowed Mode</i> .
	Click to take a snapshot (screen capture) of the remote display. See Snapshot for details on configuring the <i>Snapshot</i> parameters.
	Click to access the Message Board.
	Click to send a Ctrl+Alt+Del command to the remote system.
	Click to toggle the remote display between color and grayscale views.
	Click to zoom the remote display window. Note: This feature is only available in windowed mode (<i>Full Screen Mode</i> is off).
	Click to access the on-screen keyboard.
	Click to select the mouse pointer type. Note: This icon changes depending on which mouse pointer type is selected.
	Click to toggle Automatic or Manual mouse sync. <ul style="list-style-type: none"> When the selection is <i>Automatic</i>, a green √ appears on the icon. When the selection is <i>Manual</i>, a red X appears on the icon. See Mouse DynaSync Mode for a complete explanation of this feature.
	Click to display a dropdown list of <i>User</i> macros to access and run macros more conveniently than using the Macros dialog box.
	Under an accessed port, click to skip to the first port accessible to the user on the entire installation without having to recall the Port Access page.
	Under an accessed port, click to skip to the first port accessible to the user that is previous to the current one without having to recall the Port Access page.
	Under an accessed port, click to skip to the first port accessible to the user that is after the current one without having to recall the Port Access page.
	Under an accessed port, click to skip to the last port accessible to the user on the entire installation without having to recall the Port Access page.
	Under an accessed port, click to begin Auto Scan Mode. The KVM over IP switch automatically switches among the ports that were selected for Auto Scanning with the Filter. This allows you to monitor their activity without having to switch among them manually.
	Under an accessed port, click to invoke Panel Array Mode (see 7.13.3 Panel Array Mode).

7. Administration

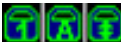
Icon	Function
	Under an accessed port, click to recall the GUI.
	Click to access the Control Panel Configuration dialog box.
	Click to exit the viewer. <ul style="list-style-type: none"> • Exiting from a Browser Viewer session brings you back to the web browser Main Page. • Exiting from a WinClient AP session brings you back to the login dialog box. • Exiting from a Java Client AP session brings you back to the login dialog box.
	<p>These icons show the Num Lock, Caps Lock and Scroll Lock status of the remote computer.</p> <ul style="list-style-type: none"> • When the lock state is <i>On</i>, the LED is bright green and the lock hasp is closed. • When the lock state is <i>Off</i>, the LED is dull green and the lock hasp is open. <p>Click on the icon to toggle the status.</p> <p>Note: <i>These icons and your local keyboard icons are in sync. Clicking an icon causes the corresponding LED on your keyboard to change accordingly. Pressing a Lock key on your keyboard will cause the icon's color to change accordingly.</i></p>

Macros

 The Macros icon provides access to three functions found in the Macros dialog box: Hotkeys, User Macros and System Macros.

Hotkeys

Various actions related to manipulating the remote server can be accomplished with hotkeys. The *Hotkey Setup* utility (accessed by clicking the icon) lets you configure which hotkeys perform the actions.

The hotkeys that invoke an action are shown to the right of its name. Use the checkbox to the left of an action's name to enable or disable its hotkey.

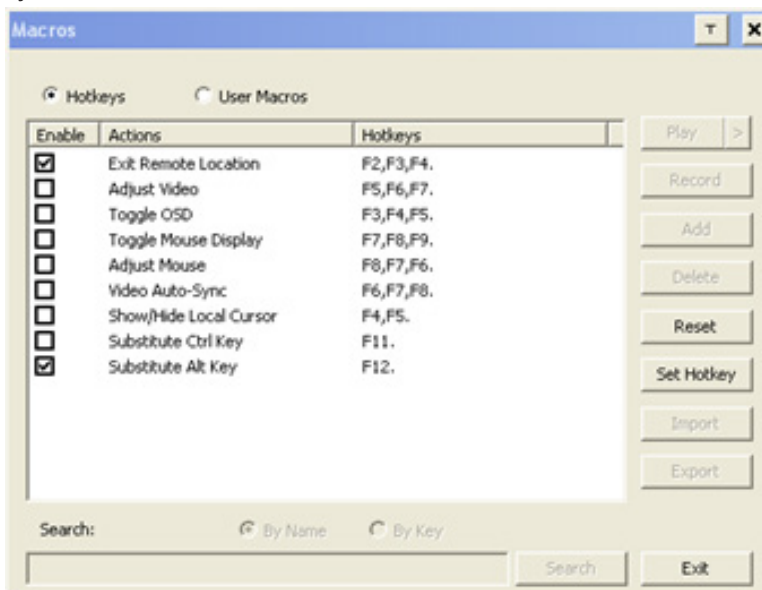

7. Administration

To change the hotkey for an action, do the following:

1. Highlight the *Action*, then click **Set Hotkey**.
2. Press your selected Function keys (one at a time). The key names appear in the Hotkeys field as you press them.
 - You can use the same function keys for more than one action, so long as the key sequence is not the same.
 - To cancel setting a hotkey value, click **Cancel**; to clear an action's Hotkeys field, click **Clear**.
3. Once you have finished keying in your sequence, click **Save**.

To reset all the hotkeys to their default values, click **Reset**.

An explanation of the Hotkey actions is provided in the table below:

Action	Explanation
Exit Remote Location	Breaks the connection to the B064C-16-1-IP and returns you to local client computer operation. This is equivalent to clicking the Exit icon on the Control Panel. The default keys are F2, F3, F4.
Adjust Video	Opens the <i>Video Settings</i> dialog box. This is equivalent to clicking the <i>Video Settings</i> icon on the Control Panel. The default keys are F5, F6, F7.
Toggle OSD	Toggles the OSD Control Panel Off and On. The default keys are F3, F4, F5.
Toggle Mouse Display	If you find the display of the two mouse pointers (local and remote) to be confusing or troublesome, you can use this function to shrink the non-functioning pointer down to a barely noticeable tiny circle which can be ignored. Since this function is a toggle, use the hotkeys again to bring the mouse display back to its original configuration. This is equivalent to selecting the Single pointer type from the <i>Mouse Pointer</i> icon on the Control Panel. The default keys are F7, F8, F9. Note: <i>The Java Control Panel does not have this feature.</i>
Adjust Mouse	This synchronizes the local and remote mouse movements. The default keys are F6, F7, F8.
Video Autosync	This combination performs an auto-sync operation. It is equivalent to clicking the <i>Video Autosync</i> icon on the Control Panel. The default keys are F8, F7, F6.
Show/Hide Local Cursor	Toggles the display of your local mouse pointer off and on. This is equivalent to selecting the <i>Null Pointer</i> type from the <i>Mouse Pointer</i> icon on the Control Panel. The default keys are F4, F5.
Substitute Ctrl key	If your local client computer captures Ctrl key combinations and prevents them from being sent to the remote server, you can implement their effects on the remote server by specifying a function key to substitute for the Ctrl key. If you substitute the F11 key, for example, pressing [F11 + 5] would appear to the remote server as [Ctrl + 5]. The default key is F11.
Substitute Alt key	Although all other keyboard input is captured and sent to the B064C-16-1-IP switch, [Alt + Tab] and [Ctrl + Alt + Del] work on your local client computer. To implement their effects on the remote server, another key may be substituted for the Alt key. If you substitute the F12 key, for example, you would use [F12 + Tab] and [Ctrl + F12 + Del]. The default key is F12.

7. Administration

User Macros

User Macros are created to perform specific actions on the remote server. To create the macro, do the following:

1. Select *User Macros*, then click **Add**.

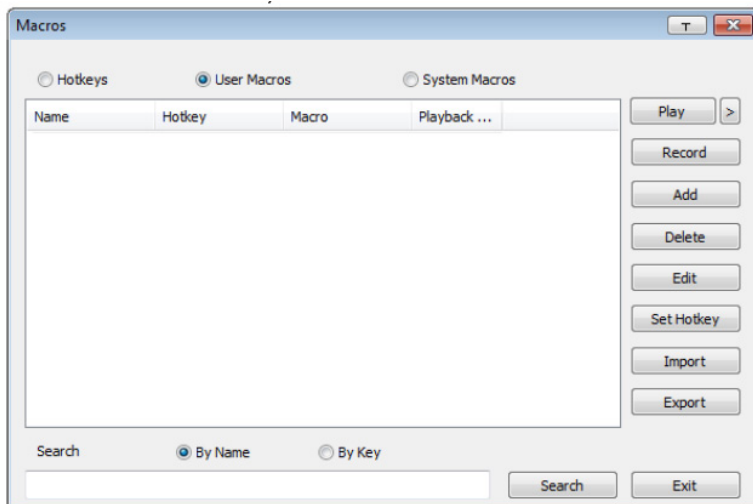

2. In the dialog box that opens, replace the "New Macro" text with a name of your choice for the macro:

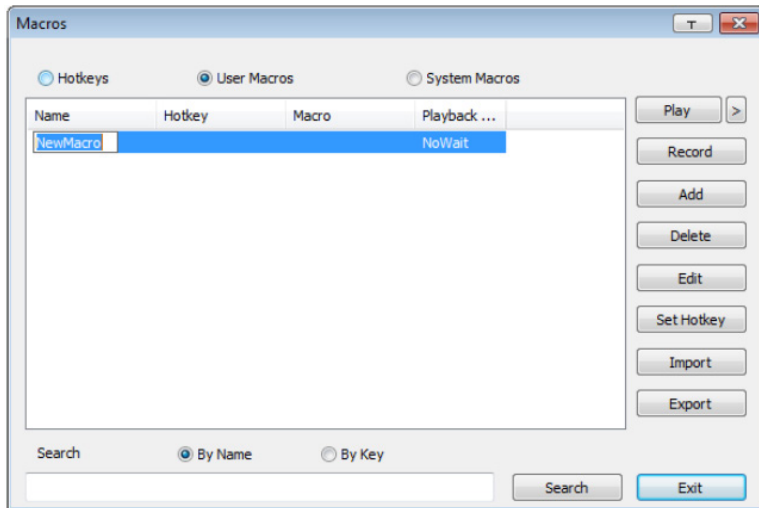

3. Click **Record**.

The dialog box disappears and a small panel appears at the top left of the screen:



7. Administration

- Press the keys for the macro.
 - To pause macro recording, click **Pause**. To resume, click **Pause** again.
 - Clicking **Show** opens a dialog box that lists each keystroke you make, together with the amount of time each one takes:

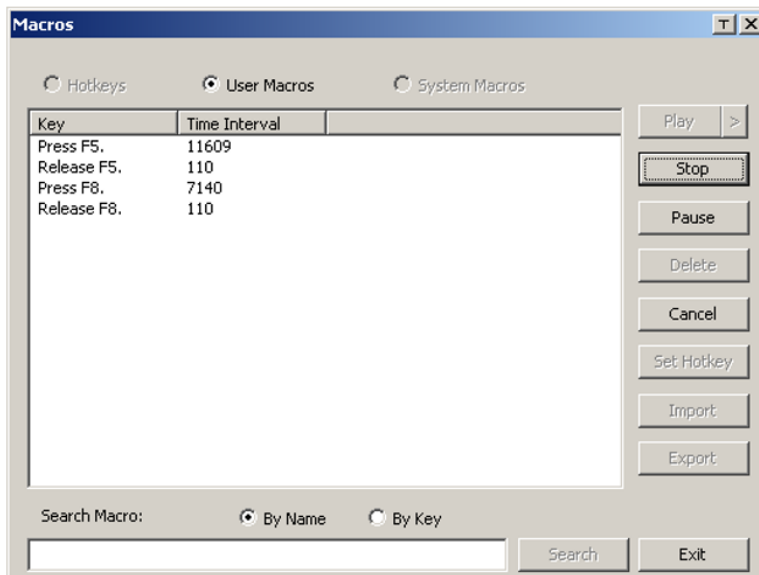

Clicking **Cancel** cancels all keystrokes.

Once you have finished, click **Stop** (this is the equivalent of clicking **Done** in Step 5).

Notes:

- Case is not considered - typing **A** or **a** has the same effect.
 - When recording the macro, the focus must be on the remote screen. It cannot be in the macro dialog box.
 - Only the default keyboard characters may be used. Alternate characters cannot be used. For example, if the keyboard is Traditional Chinese and default character is **A**, the alternate Chinese character obtained via keyboard switching is not recorded.
- If you have not opened the Show dialog, click **Done** when you have finished recording your macro. You return to the Macros dialog box with your macro key presses displayed in the Macro column:

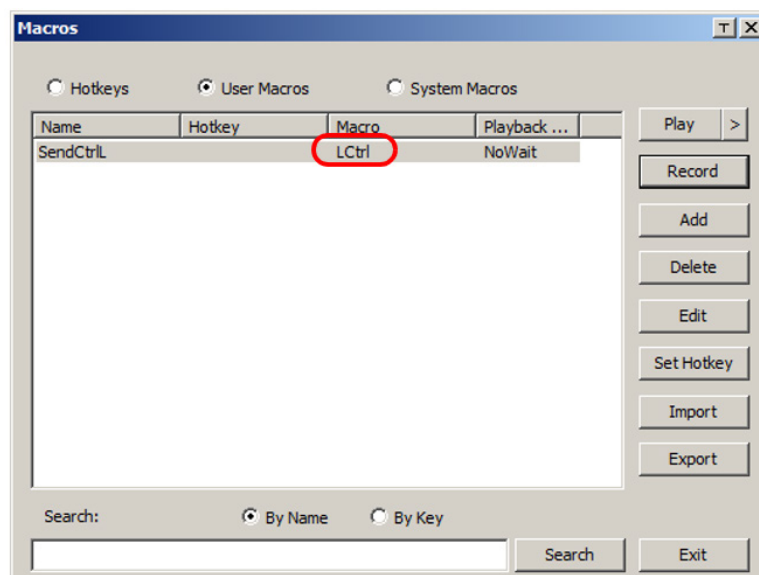

7. Administration

6. If you want to change any of the keystrokes, select the macro and click **Edit**. This will open a dialog box similar to the one for Show. You can change the content of your keystrokes, change their order, etc.

7. Repeat the procedure for any other macros you wish to create.

After creating your macros, you can run them in any of three ways:

1. Using the hotkey (if one was assigned).
2. Opening the *Macro List* on the *Control Panel* and clicking the one you want.
3. Opening this (Macros) dialog box and clicking **Play**.

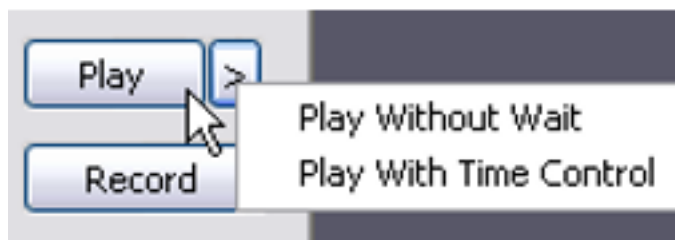

If you run the macro from this dialog box, you have the option of specifying how the macro runs.

- If you choose *Play Without Wait*, the macro runs the key presses one after another with no time delay between them.
- If you choose *Play with Time Control*, the macro waits for the amount of time between key presses that you took when you created it. Click on the arrow next to **Play** to make your choice.
- If you click **Play** without opening the list, the macro runs with the default choice (*NoWait* or *TimeCtrl*), which is shown in the *Playback* column.

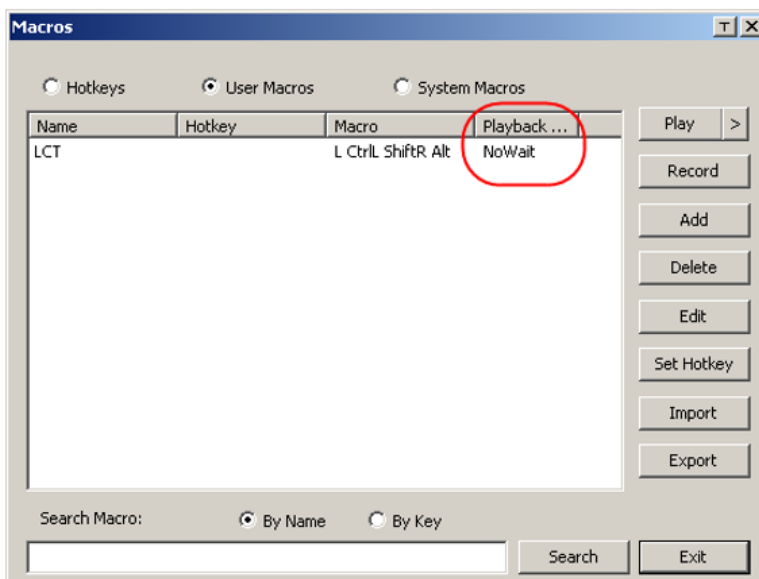

Note: User Macros are stored on the Local Client computer of each user. Therefore, there is no limitation on the of number of macros, size of the macro names or makeup of the hotkey combinations that invoke them.

Search

Located at the bottom of the dialog box, the Search button lets you filter the list of macros that appear in the large upper panel for you to play or edit. Click a radio button to choose whether you want to search by name or by key, key in a string for the search, then click **Search**. All instances that match your search string will appear in the upper panel.

7. Administration

System Macros

System Macros are used to create exit macros for when you close a session. For example, as an added measure of security, you can create a macro that sends the Winkey-L combination which would cause the remote server's log in page to open the next time the device was accessed. To create the macro:

1. Select *System Macros*, then click **Add**.

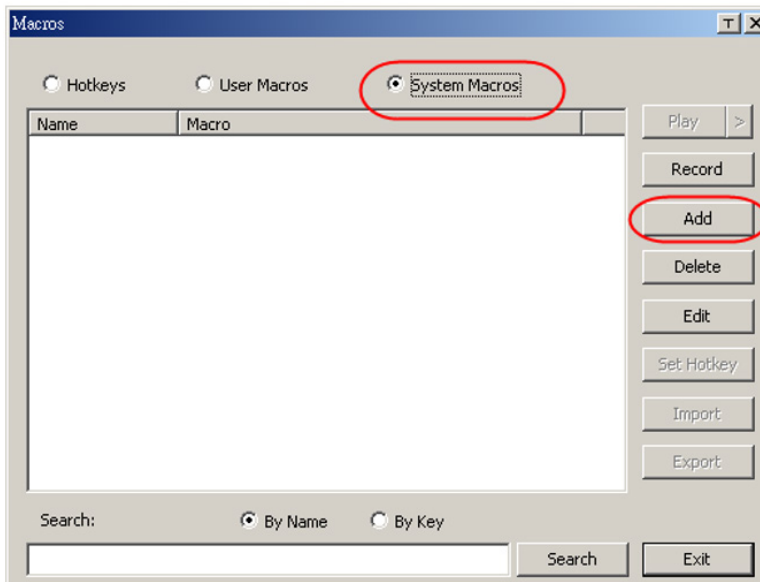

2. In the dialog box that opens, replace the "New Macro" text with a name of your choice for the macro.

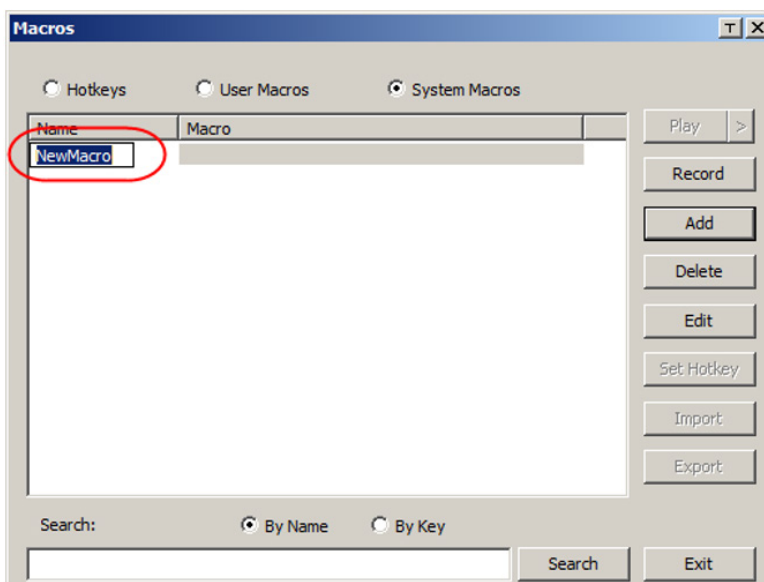

3. Click **Record**.

The dialog box will disappear and a small panel will appear at the top left of the screen.

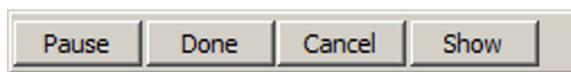

7. Administration

- Press the keys for the macro.
 - To pause macro recording, click **Pause**. To resume, click **Pause** again.
 - Clicking **Show** opens a dialog box that lists each keystroke that you make, together with the amount of time each one takes.

Notes:

- Case is not considered - typing **A** or **a** has the same effect.
 - When recording the macro, the focus must be on the remote screen. It cannot be in the macro dialog box.
 - Only the default keyboard characters may be used. Alternate characters cannot be used. For example, if the keyboard is Traditional Chinese and default character is **A** the alternate Chinese character obtained via keyboard switching is not recorded.
- If you have not opened the Show dialog, click **Done** when you have finished recording your macro. You will return to the Macros dialog box with your system macro key presses displayed in the Macro column:

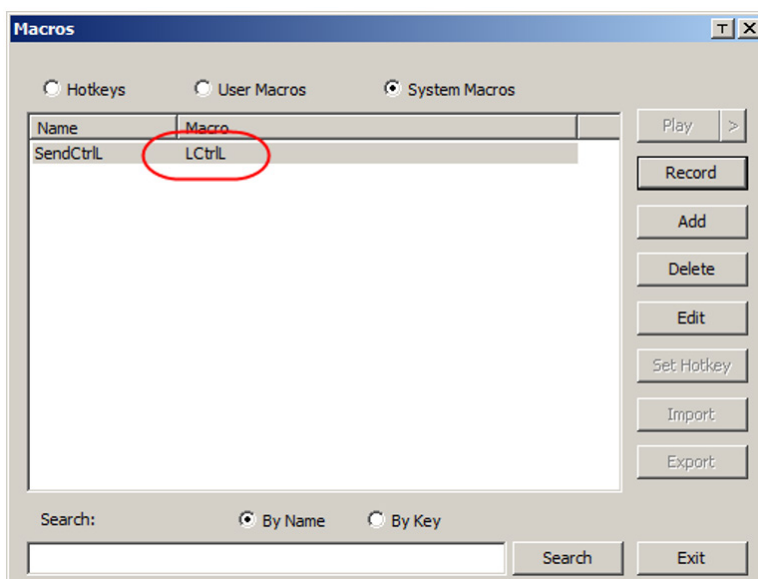

- If you want to change any of the keystrokes, select the macro and click **Edit**. This will open a dialog box similar to the one for Show. You can change the content of your keystrokes, change their order, etc.
- Repeat the procedure for any other macros you wish to create.

Once the system macros have been created, they are available for use on a port-by-port basis. They get selected on a port's *Port Configuration* → *Port Properties* page.

Notes:

- You can choose only one system macro per port.
- Systems macros are stored on the switch. Therefore, macro names may not exceed 64 Bytes and hotkey combinations may not exceed 256 Bytes (each key usually takes 3-5 Bytes).

7. Administration

Video Settings



Clicking the *Hammer* icon on the *Control Panel* opens the *Video Settings* dialog box. Click **Advanced** to view all settings. The options in this dialog box allow you to adjust the placement and picture quality of the remote screen on your monitor:

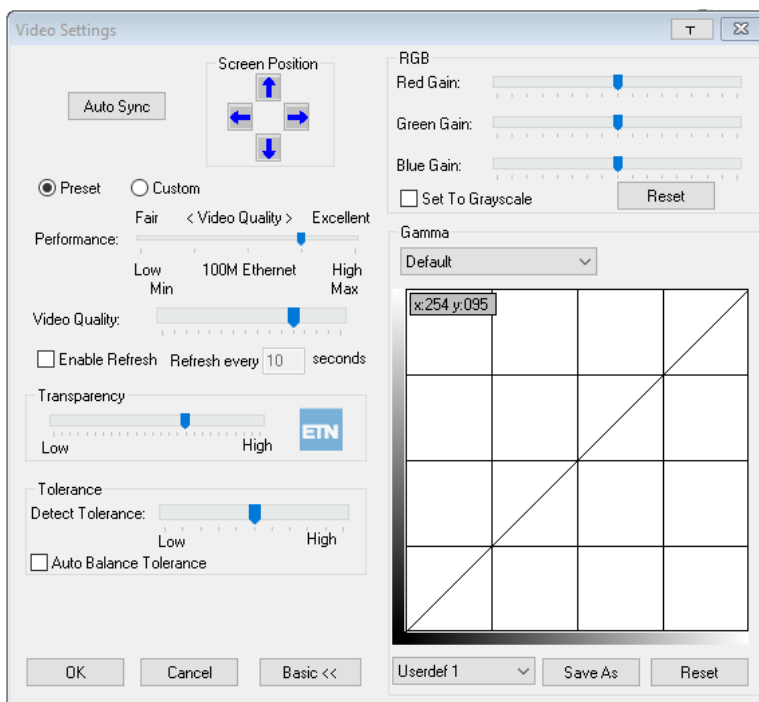

The meanings of the video adjustment options are provided in the table below:

Options	Usage
Screen Position	Adjust the horizontal and vertical position of the remote server window by clicking the arrow buttons.
Auto-Sync	Click Auto-Sync to have the vertical and horizontal offset values of the remote screen detected and automatically synchronized with the local screen. Notes: <ul style="list-style-type: none"> • If the local and remote mouse pointers are out of sync, in most cases, performing this function will bring them back into sync. • This function works best with a bright screen. • If you are not satisfied with the results, use the Screen Position arrows to position the remote display manually.
RGB	Drag the slider bars to adjust the RGB (Red, Green, Blue) values. When an RGB value is increased, the RGB component of the image is increased accordingly. If you enable <i>Set to Grayscale</i> , the remote video display is changed to grayscale.
Gamma	This section allows you to adjust the video display's gamma level.
Performance	Drag the slide bar to adjust the bandwidth connection that the local client computer uses. The switch will use that selection to automatically adjust the <i>Video Quality</i> and <i>Detect Tolerance</i> settings to optimize the quality of the video display. Since network conditions vary, if none of the preset choices seem to work well, you can select <i>Customize</i> and use the <i>Video Quality</i> and <i>Detect Tolerance</i> slider bars to adjust the settings to suit your conditions.

7. Administration

Options	Usage
Video Quality	Drag the slider bar to adjust the overall video quality. The larger the value, the clearer the picture and the more video data goes through the network. Depending on the network bandwidth, a high value may adversely effect response time.
Enable Refresh	<p>The B064C-16-1-IP can redraw the screen every 1 to 99 seconds, eliminating unwanted artifacts from the screen. Select Enable Refresh and enter a number from 1 through 99. The B064C-16-1-IP will redraw the screen at the interval you specify. This feature is disabled by default. Click to put a check mark in the box next to <i>Enable Refresh</i> to enable this feature.</p> <p>Notes:</p> <ul style="list-style-type: none"> • <i>The switch starts counting the time interval when the mouse movement stops.</i> • <i>Enabling this feature increases the volume of video data transmitted over the network. The lower the number specified, the more often the video data is transmitted. Setting too low a value may adversely affect overall operating responsiveness.</i>
Transparency	Adjusts the transparency of the toolbar that appears when the OSD hotkey ([Scroll Lock][Scroll Lock], for example) is invoked. Slide the bar until the display in the example window is to your liking.
Color Depth Control	This setting determines the richness of the video display by adjusting the amount of color information.
Detect Tolerance	This setting also relates to video quality. It governs detecting or ignoring pixel changes. A high setting can result in a lower quality display due to less data transfer. A lower setting will result in better video quality, but setting the threshold too low may allow too much data to be transferred, negatively impacting network performance.
Auto Balance Tolerance	Check this box to allow the system to automatically adjust the tolerance settings.

7. Administration

Gamma Adjustment

If it is necessary to correct the gamma level for the remote video display, use the *Gamma* function of the Video Adjustment dialog box.

- Under *Basic* configuration, there are ten preset and four user-defined levels to choose from. Drop down the list box and choose the most suitable one.
- For greater control, clicking the *Advanced* button opens the following dialog box:

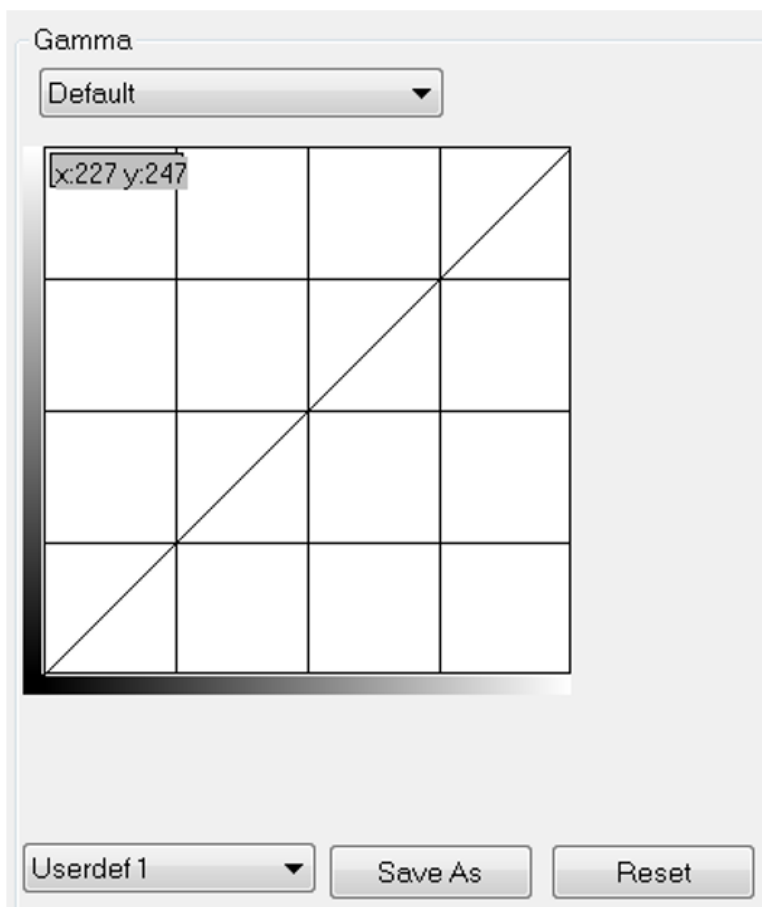

- Click and drag the diagonal line at as many points as you wish to achieve the display output you desire.
- Click **Save As** to save up to four user-defined configurations derived from this method. Saved configurations can be recalled from the list box at a future time.
- Click **Reset** to abandon any changes and return the gamma line to its original diagonal position.
- Click **OK** to save your changes and close the dialog box.
- Click **Cancel** to abandon your changes and close the dialog box.

Note: For optimal results, change the gamma setting while viewing a remote server.

Network Bandwidth Information for KVM Sessions

For network bandwidth management, a KVM session of a full-screen video display at 1920 x 1080 @ 60 Hz will take up approximately 64 Mbps.

However, since the network environment of each station/session varies, the aforementioned information proposes what is ideal but does not warrant the smoothness/quality for each session.

7. Administration

The Message Board



The B064C-16-1-IP supports multiple user logins, which may cause access conflicts. To alleviate the problem, a message board is provided to allow users to communicate with one other:

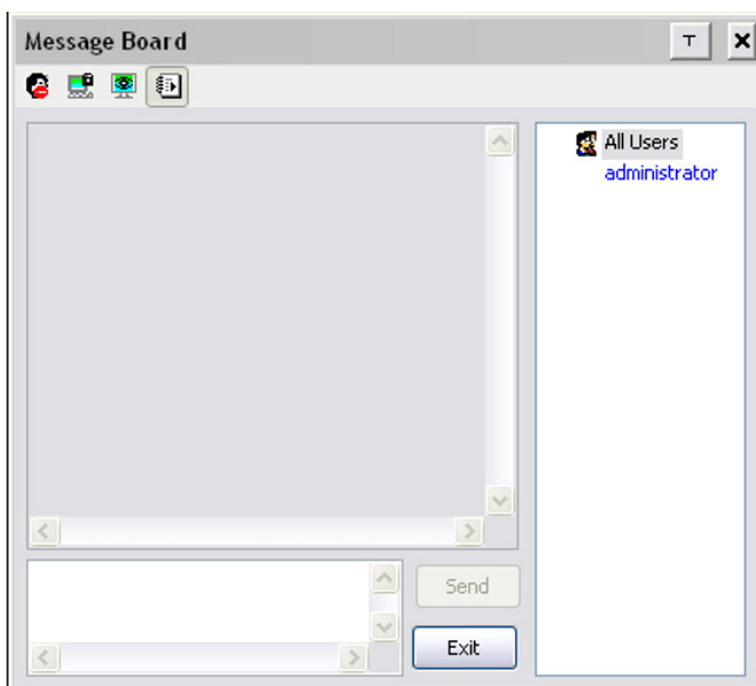

Button Bar

The buttons on the Button Bar are toggles.

Button	Action
	Enable/Disable Chat: When disabled, messages posted to the board are not displayed. The button is shadowed when Chat is disabled. The icon displays next to the user's name in the User List panel when the user has disabled Chat.
	Occupy/Release Keyboard/Video/Mouse: When you Occupy the KVM, other users cannot see the video, nor input keyboard or mouse data. The button is shadowed when the KVM is occupied. The icon displays next to the user's name in the User List panel when the user has occupied the KVM.
	Occupy/Release Keyboard/Mouse: When you Occupy the KM, other users can see the video, but cannot input keyboard or mouse data. The button is shadowed when the KM is occupied. The icon displays next to the user's name in the User List panel when the user has occupied the KM.
	Show/Hide User List: When you hide the User List, the User List panel closes. The button is shadowed when the User List is open.

Message Display Panel

Messages that users post to the board (as well as system messages) display in this panel. If you disable Chat, messages that get posted to the board will not appear.

Compose Panel

Key in the messages that you want to post to the board in this panel. Click **Send**, or press **[Enter]** to post the message to the board.

7. Administration

User List Panel

The names of all the logged in users are listed in this panel.

- Your name appears in blue and other users' names appear in black.
- By default, messages are posted to all users. To post a message to an individual user, select the user's name before sending your message.
- If a user's name is selected and you want to post a message to all users, select All Users before sending your message.
- If a user has disabled Chat, its icon displays before the user's name to indicate so.
- If a user has occupied the KVM or the KM, its icon displays before the user's name to indicate as such.

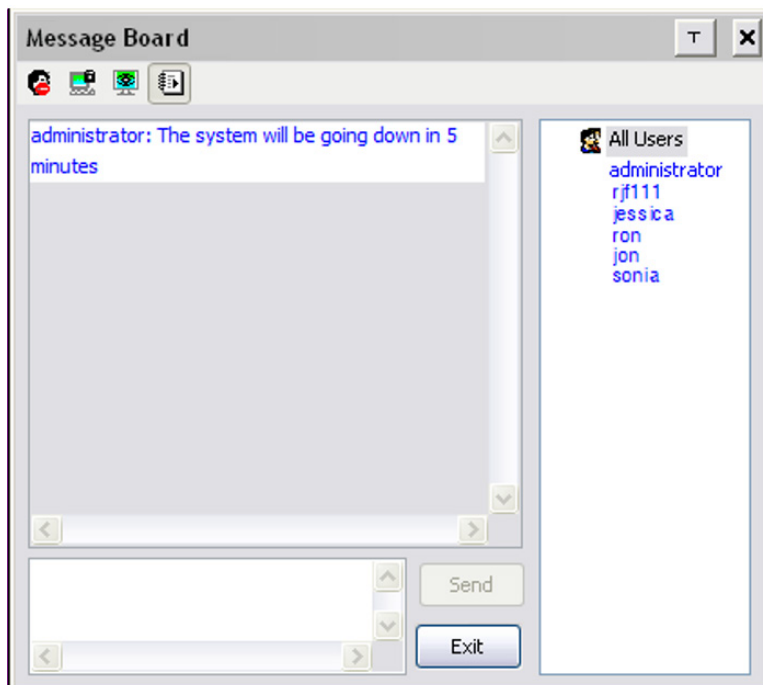

Zoom



The Zoom icon controls the zoom factor for the remote view window.

Setting	Description
100%	Sizes and displays the remote view window at 100%.
75%	Sizes and displays the remote view window at 75%.
50%	Sizes and displays the remote view window at 50%.
25%	Sizes and displays the remote view window at 25%.
1:1	Sizes and displays the remote view window at 100%. The difference between this setting and the 100% setting is that when the remote view window is resized its contents do not resize - they remain at the size they were. To see any objects that are outside of the viewing area, move the mouse to the window edge to have the screen scroll.

7. Administration

On-Screen Keyboard

 The KVM switch supports an on-screen keyboard available in multiple languages and with all the standard keys for each supported language. Click this icon to pop up the on-screen keyboard:

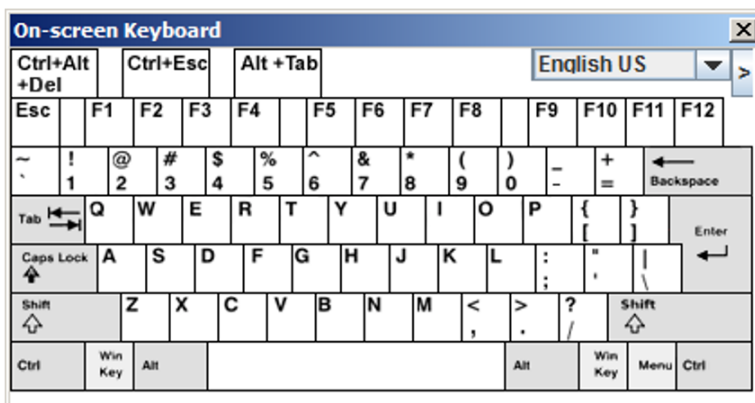

One of the major advantages of the on-screen keyboard is that if the keyboard languages of the remote and local systems are not the same, you do not need to change the configuration settings for either system. Simply access the on-screen keyboard, select the language used by the server you are accessing and use the on-screen keyboard to communicate with it.

Note: You must use your mouse to click on the keys. You cannot use your actual keyboard.

Changing Languages

1. Click the down arrow next to the currently selected language to view a drop-down selection of the language list.



2. Select the new language from the list.

7. Administration

Expanded Keyboard

To display/hide the expanded keyboard keys, click the arrow to the right of the language list arrow.

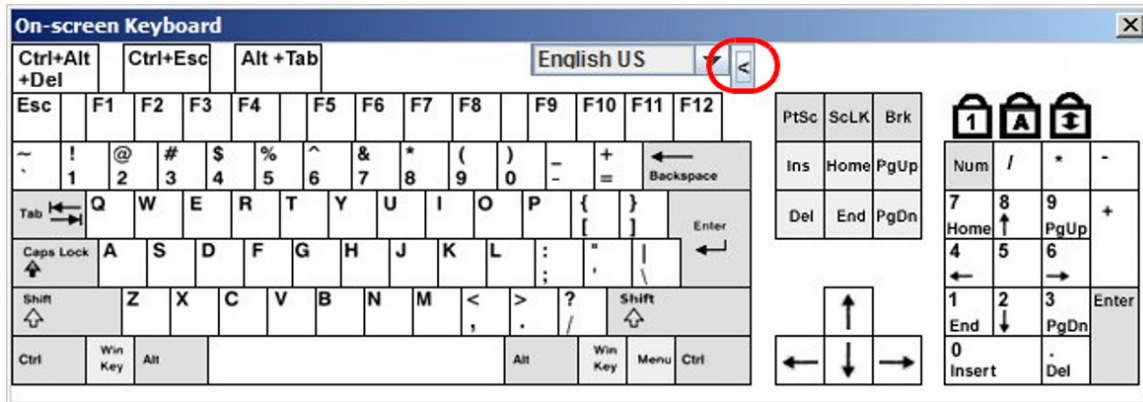

Mouse Pointer Type



KVM switches offer several mouse pointer options when working in the remote display. Click this icon to select from the available choices:

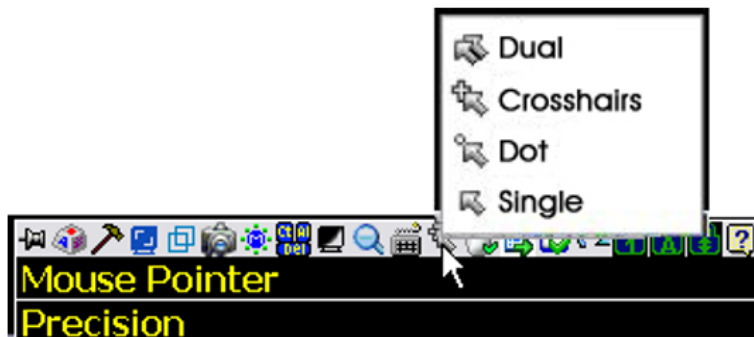

Notes:

- Before accessing a port, only Dual and Crosshairs are available for Windows Viewers. Once the port is accessed, all four pointers are available.
- The Dot pointer is not available with the Java Applet Viewer or the Java Client AP.
- Selecting the Dot pointer has the same effect as the Toggle mouse display hotkey function.
- The icon on the Control Panel changes to match your choice.

Mouse DynaSync Mode



Synchronization of the local and remote mouse pointers is accomplished automatically or manually.

Automatic Mouse Synchronization (DynaSync)



Mouse DynaSync provides automatic locked-in syncing of the remote and local mouse pointers, eliminating the need to constantly resync the two movements.

Notes:

- This feature is only available for Windows and Mac systems (G4 or later) whose adapter attribute OS setting is configured for Win or Mac.
- All other configurations must use manual mouse synchronization.

7. Administration

The icon on the Control Panel indicates the synchronization mode status as follows:

Icon	Function
	This icon displays in gray to indicate that Mouse DynaSync is not available and you must use manual syncing procedures. This is the default setting for all KVM Adapters.
	The green check mark on this icon indicates Mouse DynaSync is available and enabled. This is the default setting when Mouse DynaSync is available.
	The red X on this icon indicates Mouse DynaSync is available but is not enabled.

When *Mouse DynaSync* is available, clicking the icon toggles its status between enabled and disabled. If you choose to disable *Mouse DynaSync* mode, you must use the manual syncing procedures described in the Manual Mouse Synchronization section.

Mac Considerations

For Mac OS versions 10.4.11 or later, there is a second DynaSync setting to choose from. If the default Mouse DynaSync result is not satisfactory, try the Mac 2 setting. To select Mac 2, right-click in the text area of the Control Panel and select *Mouse Sync Mode* → *Automatic for Mac 2*:

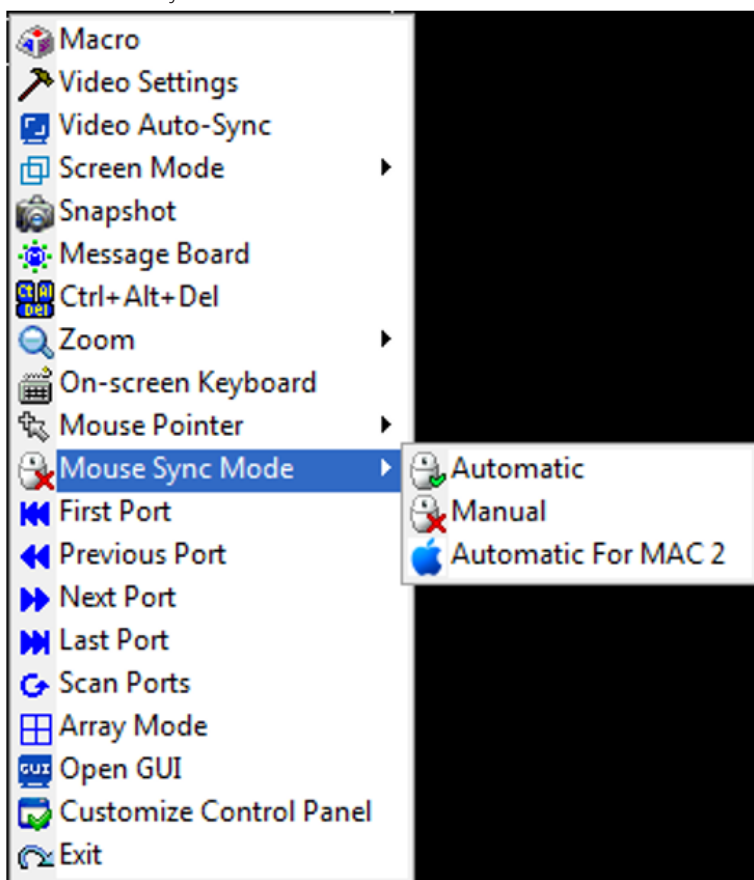

7. Administration

Manual Mouse Synchronization

If the local mouse pointer becomes out of sync with the remote system's mouse pointer, there are several methods to return them to sync:

1. Perform a video and mouse auto sync by clicking the *Video Settings* icon on the Control Panel.
2. Perform an *Auto Sync* with the Video Adjustment function.
3. Invoke the *Adjust Mouse* function with the *Adjust Mouse* hotkeys.
4. Move the pointer into all four corners of the screen (in any order).
5. Drag the Control Panel to a different position on the screen.
6. Set the mouse speed and acceleration for each problematic server attached to the switch. See **8.9 Additional Mouse Synchronization Procedures** for details.

Control Panel Configuration



Clicking the *Control Panel* icon opens a dialog box that allows you to configure the items that appear on the Control Panel, as well as its graphical settings:

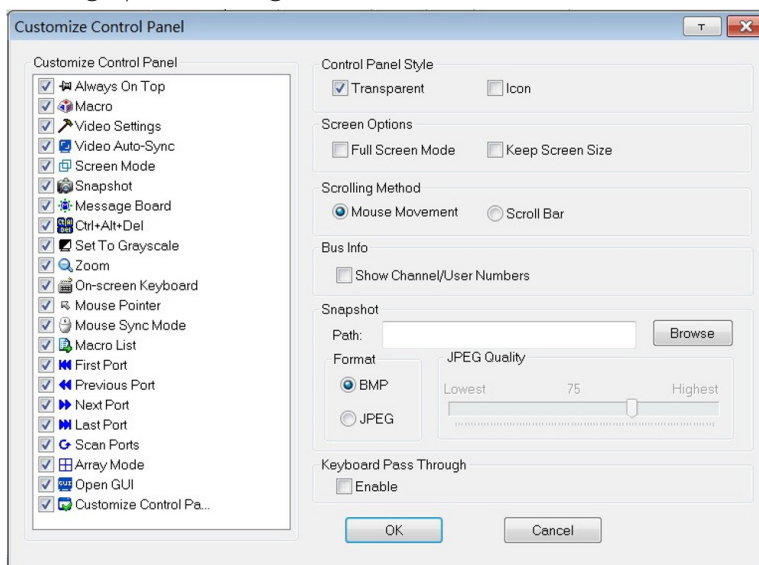

The organization of the dialog box is described in the table below:

Item	Description
Customize Control Panel	Allows you to select which icons display in the Control Panel. Check the ones you want to view and uncheck the ones you do not want to view.
Control Panel Style	<ul style="list-style-type: none"> • Enabling <i>Transparent</i> makes the Control Panel semi-transparent so you can see through to the display underneath. • Enabling <i>Icon</i> causes the Control Panel to display as an icon until you mouse over it when the full panel, then opens.
Screen Options	<ul style="list-style-type: none"> • If <i>Full Screen Mode</i> is enabled, the remote display will fill the entire screen. • If <i>Full Screen Mode</i> is not enabled, the remote display will appear as a window on the local desktop. If the remote screen is larger than what is able to fit in the window, move the mouse pointer to the screen border that is closest to the area you want to view and the screen will scroll. <ul style="list-style-type: none"> o If <i>Keep Screen Size</i> is enabled, the remote screen is not resized. If the remote resolution is smaller than that of the local monitor, its display appears like a window centered on the screen. o If the remote resolution is larger than that of the local monitor, its display is centered on the screen. To access the areas that are off screen, move the mouse to the corner of the screen that is closest to the area you want to view and the screen will scroll. • If <i>Keep Screen Size</i> is not enabled, the remote screen is resized to fit the local monitor's resolution.

7. Administration

Item	Description
User Info	If <i>User Info</i> is enabled, the total number of users displays on the bottom row center of the Control Panel.
Snapshot	<p>These settings let the user configure the B064C-16-1-IP's screen capture parameters:</p> <ul style="list-style-type: none"> • Path lets you select a directory that the captured screens automatically get saved to. Click Browse, navigate to the directory of your choice, then click OK. If you do not specify a directory here, the snapshot is saved to your desktop. • Click a radio button to choose whether you want the captured screen to be saved as a BMP or a JPEG (JPG) file. • If you choose JPEG, you can select the quality of the captured file with the slider bar. The higher the quality, the better looking the image, but the larger the file size.
Keyboard Pass Through	When this is enabled, the Alt-Tab key press is passed to the remote server and affects that server. If it is not enabled, Alt-Tab acts on your local client computer.

The Java Control Panel

The Java Client AP Control Panel is similar to the one used by the WinClient:

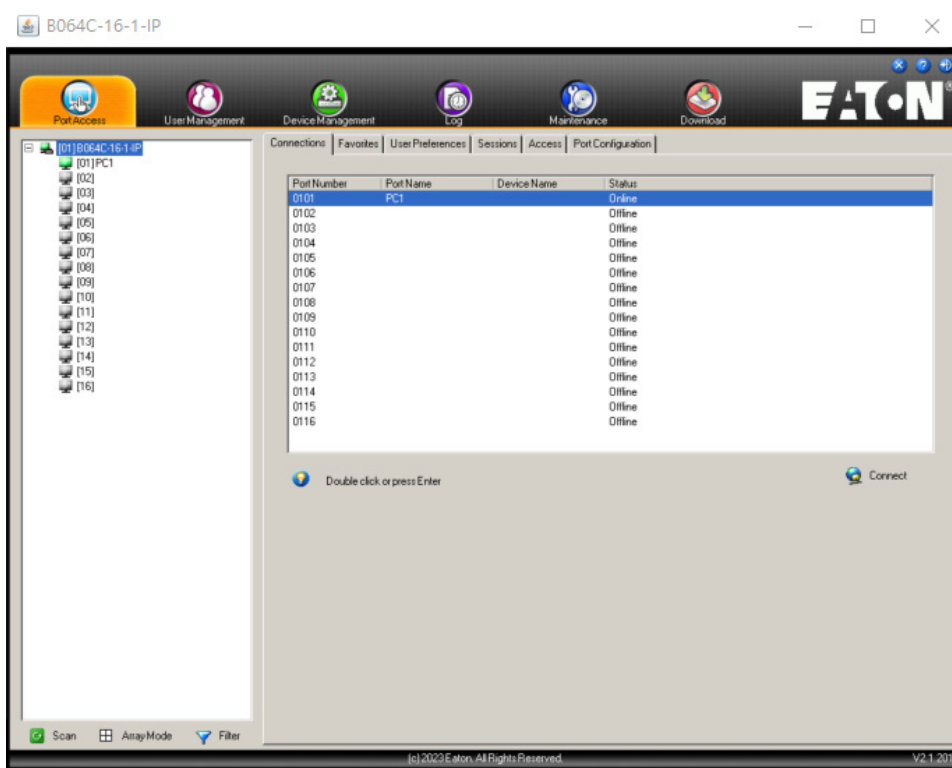

7. Administration

The major differences between them are:

- In the Macros dialog box, *Toggle Mouse Display* is not available.
- The *Dot* mouse pointer type is not available.
- In the Message Board, there is no *Show/Hide* button to show or hide the user list. This function is achieved by clicking the arrows at the top of the bar that separates the User List panel from the Main panel.
- The Control Panel *Lock LED* icons are not in sync with your keyboard.
 - When you first connect, the LED display may not be accurate. To be sure, click on the LED icons to set them.
- In *Control Panel Configuration*, the BMP Snapshot format has been replaced by PNG.

7.7 Port Access

When you log in to the switch, the *Port Access* page opens with the B064C-16-1-IP's KVM *Connections* page displayed.

Browser GUI

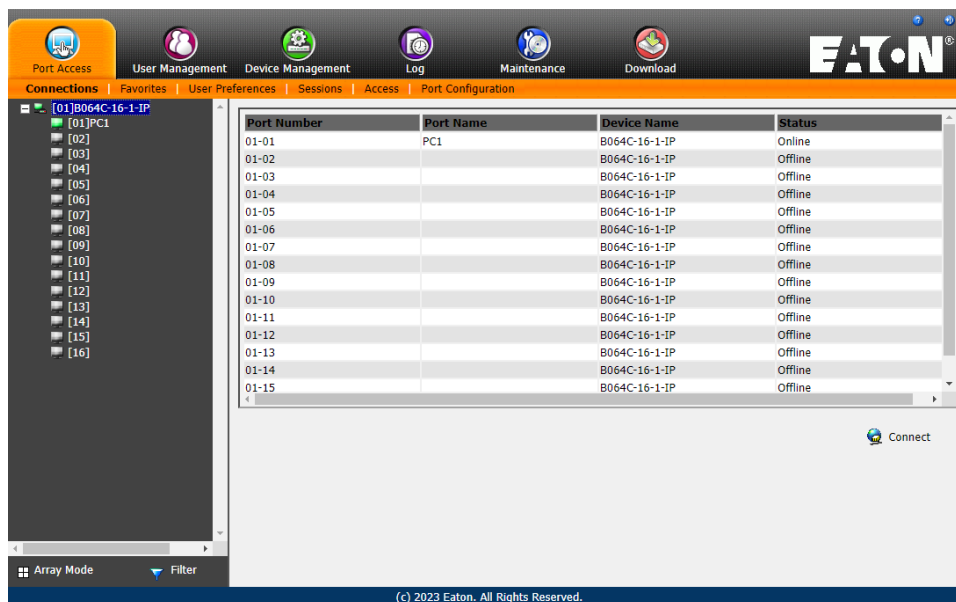

7. Administration

AP GUI

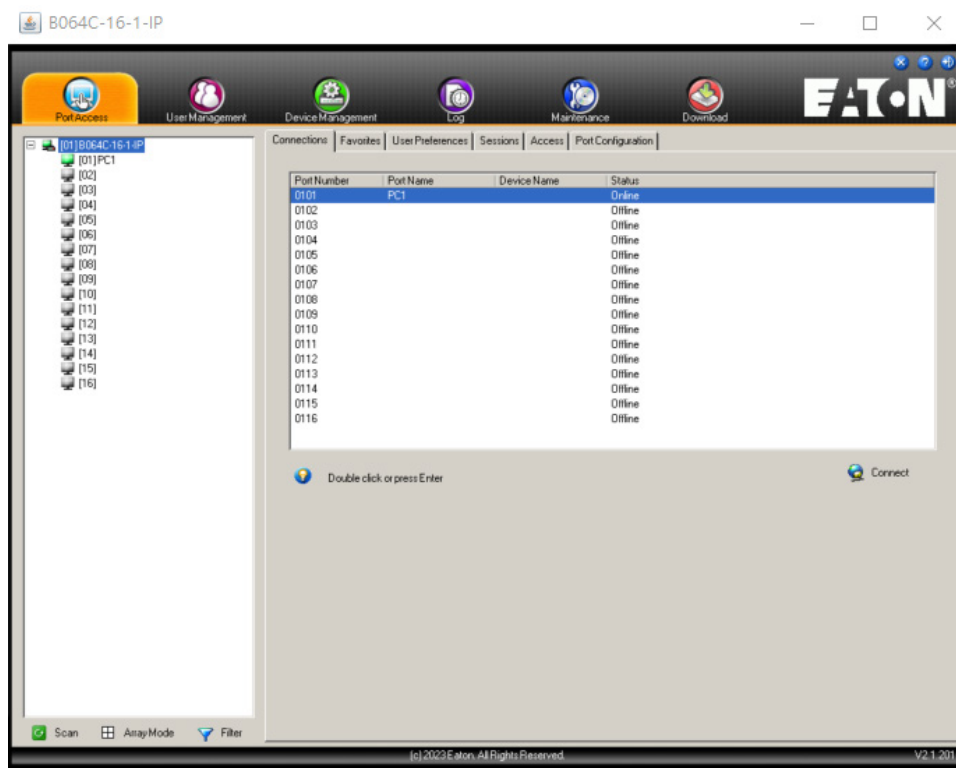

The Connections page is organized into several main areas. All devices and ports that a user is permitted to access are listed in the Sidebar at the left of the page. After selecting a device or port in the Sidebar, clicking entries on the menu bar (Browser GUI) or tab bar (AP GUI) opens information and configuration pages related to the item selected in the Sidebar.

7.7.1 Sidebar

All KVM switches are listed in a tree structure in the Sidebar at the left of the screen:

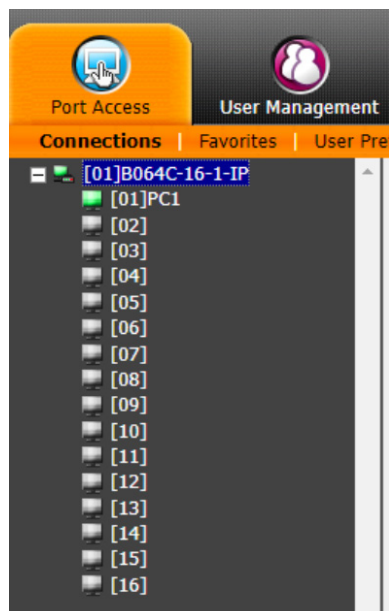

7. Administration

Sidebar Tree Structure

- Users are only allowed to see the devices and ports they have access permission for.
- Ports and chained station devices can be nested under their first station devices.
Click the + in front of a device to expand the tree and see the ports/outlets nested underneath it. Click the - to collapse the tree and hide the nested ports/outlets.
- A port's ID number is displayed in brackets next to its icon.
- Online switches and ports will have their monitor screen icons in Green; Gray monitor screens are for devices and ports that are offline.
- Outlets that are *On* will have their icons in Amber; the Gray icons are for outlets that are *Off*.
- To access and operate a port, double click its icon. Port operation details are discussed in **7.13 Port Operation**.

Scan



Scan is found at the bottom of the AP GUI Sidebar. It automatically switches among all the ports that are visible in the Sidebar at regular intervals so that their activity can be monitored automatically.

Note: This item does not appear at the bottom of the Sidebar in the Browser version. In that version, you must invoke it from the port's Toolbar.

Array



Array is found at the bottom of the Browser and AP GUI Sidebar. It represents another way of monitoring port activity. Under this function, your screen is divided into a grid of panels with each panel showing the video display of a particular port. Only ports that are visible in the Sidebar and that are online are displayed - all other ports are blank.

Note: This item does not appear at the bottom of the Sidebar in the Browser version. In that version, you must invoke it from the port's Toolbar.

7. Administration

7.7.2 Filter

At the bottom of the sidebar are the filter options that allow you to control the number and type of ports that display in the Sidebar:

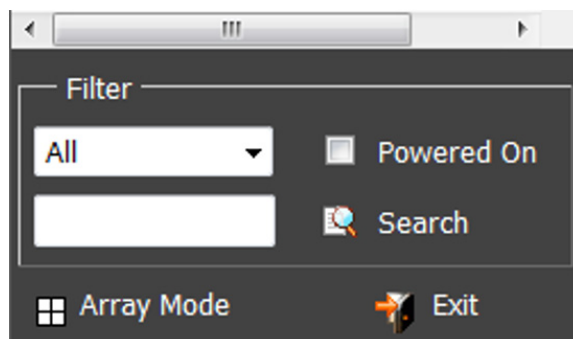

The meanings of the choices are explained in the following table:

Choices	Explanation
All	This is the default view. With no other filter options selected, all the ports that are accessible to the user are listed in the Sidebar. If any Favorites have been specified, you can drop down the list box and select Favorites instead of All. If you select Favorites, only the items you have selected as Favorites display in the tree.
Powered On	If you enable Powered On (by putting a check in the checkbox), only the ports that have their attached devices powered on display in the tree.
Search	If you key in a search string and click Search , only port names that match the search string display in the tree. Wildcards (? for single characters; * for multiple characters) and the keyword "or" are supported, so that more than one port can show up in the list. For example: 1. If you key in Web* , both Web Server 1 and Web Server 2 show up in the list. 2. If you key in W*1 or M*2 , both Web Server 1 and Mail Server 2 show up in the list.
Array Mode	See Array for details.
Exit	Clicking Exit closes the filter dialog.

7. Administration

7.7.3 Connections

The *Connections* page displays port status information at the device level, and port connection configuration options at the port level.

Device Level

When a B064C-16-1-IP is selected in the Sidebar, the *Connections* page displays a list of ports for the device that the user is authorized to access or view.

Port Number	Port Name	Device Name	Status
01-01	PC1	B064C-16-1-IP	Online
01-02		B064C-16-1-IP	Offline
01-03		B064C-16-1-IP	Offline
01-04		B064C-16-1-IP	Offline
01-05		B064C-16-1-IP	Offline
01-06		B064C-16-1-IP	Offline
01-07		B064C-16-1-IP	Offline
01-08		B064C-16-1-IP	Offline
01-09		B064C-16-1-IP	Offline
01-10		B064C-16-1-IP	Offline
01-11		B064C-16-1-IP	Offline
01-12		B064C-16-1-IP	Offline
01-13		B064C-16-1-IP	Offline
01-14		B064C-16-1-IP	Offline
01-15		B064C-16-1-IP	Offline



The following attributes are listed for each device:

- Port Number - the port's number on the switch.
- Port Name - if a name has been assigned to a port it displays here.
- Device Name - if a name has been assigned to the switch it displays here.
- Status - the current status of the port - online or offline.
- Connect - You can access any port from the main panel by selecting it and clicking **Connect**.

Note: The sort order of the information displayed can be changed by clicking the column headings.

Port Level

When a port is selected in the Sidebar, the *Connections* page displays port connection configuration properties:

Status

Port Status: Offline

Associated Link

Link Port:

Port Number	Port Name

Status

The *Status Panel* displays the port's current status information, including whether the port is online or offline and if the port is mountable. See **7.7.8 Port Configuration** for full details about the properties and how to configure them.

Click the **Connect** button to view the port display via the B064C-16-1-IP's built-in Win Viewer (when using Windows Internet Explorer) or Java Viewer (when using other web browsers).

Associated Link

The *Associated Links* panel displays ports that have been associated with the currently selected port. Associations are configured on the *Port Access* → *Port Configuration* → *Associated Links* page.

7. Administration

7.7.4 Favorites

The *Favorites* page is similar to a bookmarks feature. Ports that you frequently access can be saved in a list here. Simply open this page and select the port - rather than hunting for it in the Sidebar. This feature is especially handy on large, crowded installations:

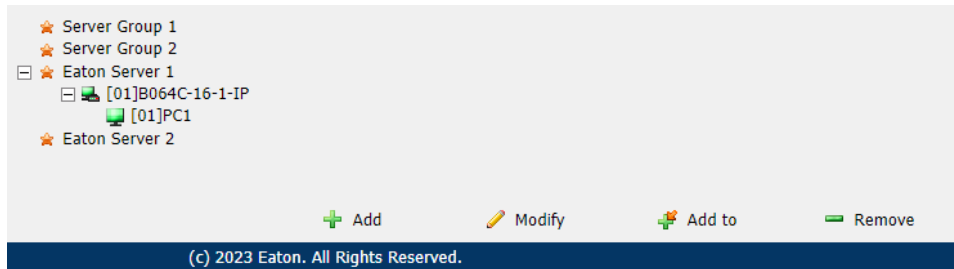

Adding a Favorite

To add a port to the favorites:

1. Right click in the main panel; click **Add Favorite**.

- or -

Click **Add** at the bottom left of the main panel.

An *Untitled Favorite* entry appears at the bottom right corner:

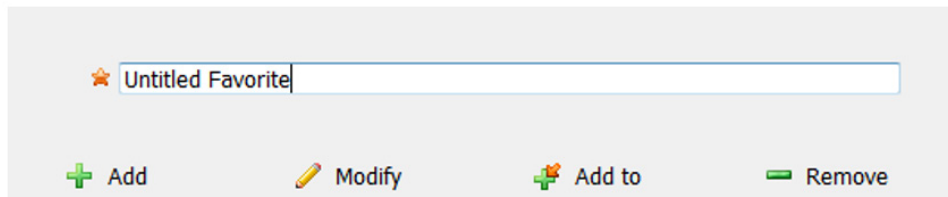

2. This will be a container to hold your port entries. Click inside the text entry box to erase *Untitled Favorite* and key in an appropriate name, then click on any empty space in the main panel.
3. To add a port, select the container in the main panel, select the port in the Sidebar, then click **Add** to at the bottom of the main panel. The switch the port belongs to is added to the container and the selected port is appended under the switch.

Note: To add multiple ports at the same time, hold the Shift or Ctrl key down while you make your Sidebar selections then drag or copy the entire group to the Favorites panel.

4. Repeat step 3 for any other Favorite categories you wish to create.



Note: Favorites can be selected for filtering in the Sidebar.

7. Administration

Modifying a Favorite

- To modify a Favorite or one of the items contained in it, right-click on it, then select a choice from the popup menu that appears.
- To edit a Favorite's name:
Click on it once, wait a second, then click again. You can edit the name after the display changes to provide a text input box.
- or -
Select the Favorite in the main panel, then click **Modify** at the bottom of the main panel.

7.7.5 User Preferences

The *User Preferences* page allows users to set up their own individual working environments. The switch stores a separate configuration record for each user profile and sets up the working configuration according to the *Username* that was keyed into the Login dialog box:

The screenshot shows a 'Settings' dialog box with the following fields and options:

- Language: English (dropdown)
- OSD Hotkey: [Scroll Lock] [Scroll Lock] (dropdown)
- ID Display: Port Number + Port Name (dropdown)
- ID Duration: 3 sec (text input)
- Scan Duration: 5 sec (text input)
- Screen Blanker: 0 min (text input)
- Logout Timeout: 0 min (text input)
- Toolbar: Enable Disable
- Viewer: Auto Detect Java Client
- Welcome Message: Hide Show
- Save button (with floppy disk icon)
- Old Password: (text input)
- New Password: (text input)
- Confirm Password: (text input)
- Change Password... button (with key icon)

The page settings are explained in the following table:

Setting	Function
Language	Selects the language that the interface displays in.
OSD Hotkey	Selects which Hotkey controls the OSD function: [Scroll Lock] [Scroll Lock] is the default. To select a different combination, click the arrow at the right of the box to drop down the list of choices.
ID Display	Selects how the Port ID is displayed: the Port Number alone (PORT NUMBER), the Port Name alone (PORT NAME) or the Port Number plus the Port Name (PORT NUMBER + PORT NAME). The default is PORT NUMBER + PORT NAME.
ID Duration	Determines how long a Port ID displays on the monitor after a port change has taken place. You can choose an amount from 1-255 seconds. The default is 3 Seconds. A setting of 0 (zero) means the Port ID is always on.
Scan Duration	Determines how long the focus dwells on each port as it cycles through the selected ports in Auto Scan Mode. Key in a value from 1-255 seconds. The default is 5 seconds; a setting of 0 disables the Scan function.

7. Administration



Setting	Function
Screen Blanker	If there is no input from the console for the amount of time set with this function, the screen is blanked. Key in a value from 1-30 minutes. A setting of 0 disables this function. The default is 0 (disabled). Note: <i>Although this function can be set from either the local console or a remote login, it only affects the local console monitor.</i>
Logout Timeout	If there is no user input for the amount of time set with this function; the user is automatically logged out. A login is necessary before the B064C-16-1-IP can be accessed again.
Toolbar	Selects whether the Port Toolbar is enabled when a port is accessed Since the Toolbar functions are also available from the GUI Control Panel, you may prefer to disable it here.
Viewer*	You can choose which viewer is used when accessing a server: <ul style="list-style-type: none">• Auto Detect will select the appropriate viewer based on the web browser used; WinClient for Windows Internet Explorer, Java Client for other web browsers (ex. Firefox).• Java Client will open the Java-based viewer regardless of the web browser being used.
Welcome Message*	You can choose to hide or show the welcome message displayed in the submenu bar. The default is disabled.
Changing a Password	<ul style="list-style-type: none">• To change a user's password in the Browser GUI, key in the old password and new password into their input boxes, key the new password into the <i>Confirm</i> input box, then click Change Password to apply the change.• In the AP GUI version, click Change Password, key in the old password and new password into their input boxes, key the new password into the <i>Confirm</i> input box, then click Save.
Save	Click Save to save any changes made to the User Preferences settings.

* This item is only available with the Browser version.

7.7.6 Sessions

The *Session* page lets the administrator and users with User Management permissions see at a glance which users are currently logged into the B064C-16-1-IP and provides information about each of their sessions.

Username	IP	Login Time	Client	Category	Devices	Ports	Bus ID
administrator	10.3.41.129	2018/02/27 03:32:45	Browser	SA	None		

Notes:

- The *Session* page is not available for ordinary users.
- Users with User Management permissions can only see the sessions of ordinary users.
- The sort order of the information displayed can be changed by clicking the column headings.

The meanings of the headings at the top of the page are straightforward. The *IP* heading refers to the IP address that the user has logged in from, the *Login Time* and *Client* tell you when and how the user logged in and the *Category* heading lists the type of user who has logged in: Admin (Administrator); Normal user (User).

This page also gives the administrator the option of forcing a user logout by selecting the user and clicking **End Session** at the bottom of the main panel.

7. Administration

7.7.7 Access

Administrators use the *Access* page to set user access and configuration rights for ports.

Note: The *Access* page only appears for users with *User Management* permissions. It is not available for other users.

Browser GUI Interface

If a port is chosen in the Sidebar, the Main panel will appear similar to the one shown below:

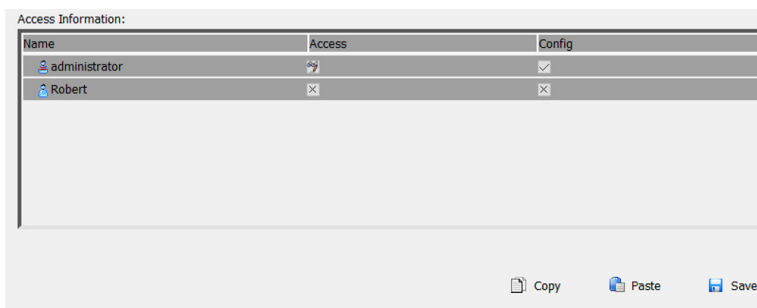

The main panel consists of two columns: *Name*, and *Access Rights*:

- *Name* lists all the users that have been created.
- *Access Rights* indicates the users who have access rights privileges. A check mark () indicates that the user has permission to make changes to the switch configuration settings (see **11. Device Management**); an X means that the user is denied permission to make configuration changes. Click the icon to toggle permission between *Full Access*, *View Only*, and *No Access*.
- *Config* indicates the users who have Configuration privileges. A check mark () indicates that the user has permission to make changes to the switch configuration settings (see **11. Device Management**); an X means that the user is denied permission to make configuration changes. Click the icon to toggle permission for Administrators and Users (Super Administrators always have configuration privileges).
- The Copy and Paste buttons at the bottom of the main panel provide a shortcut method of assigning the permissions settings of one port to any of the other ports. To do so:
 1. Select the port whose permissions you want the other port(s) to follow.
 2. Click **Copy**.
 3. Select the port you want to receive the permissions.
 4. Click **Paste**.
 5. When you have finished making your configuration changes, click **Save**.

7. Administration

AP GUI Interface

The *AP GUI Access* page is similar to the Browser GUI version.

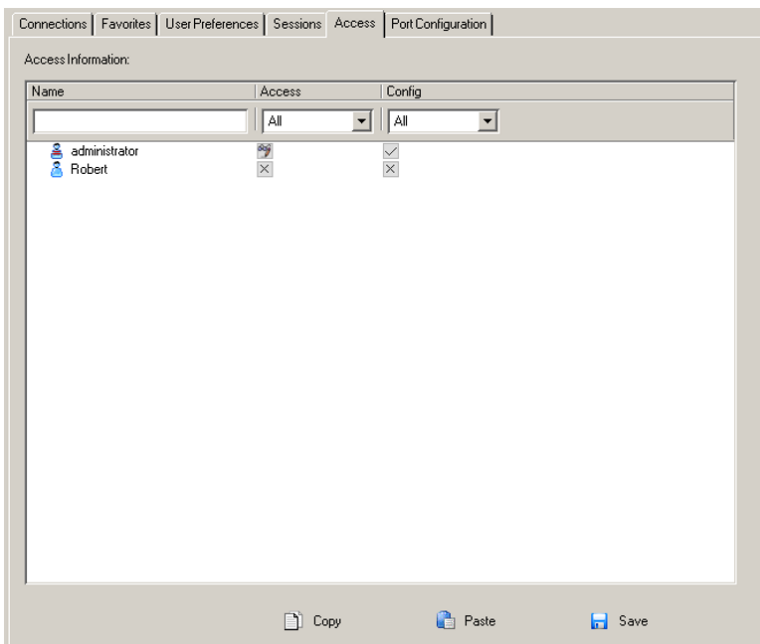

For information on using this page, see **7.7.7 Access**.

Saving Changes

Click the **Save** button at the lower right corner of the page to save any changes made on the Access page.

7.7.8 Port Configuration

The *Port Configuration* page displays status information and allows you to set the properties of a port that has been selected in the Sidebar.

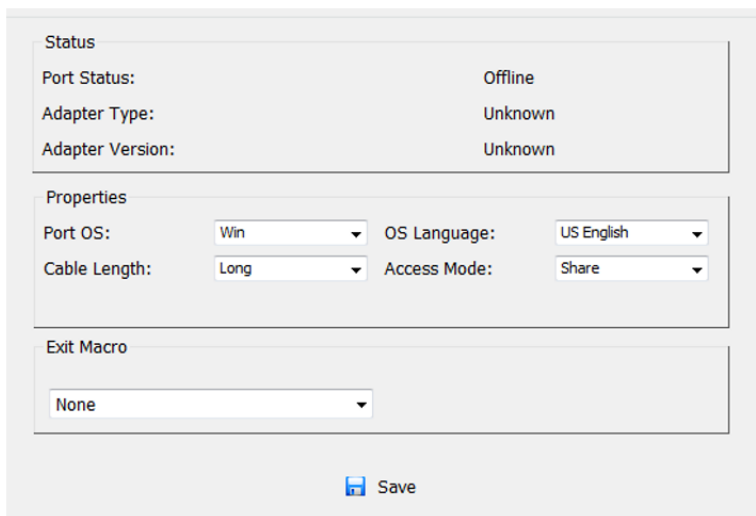

- The *Status* panel provides information as to whether port is online or offline, the Adapter cable used to connect the server (or other device) to the port and the Adapter's firmware level.
- The *Properties* panel allows you to make configuration settings for the selected port.
- The *Exit Macro* panel contains a drop-down list of user created System macros. You can select a macro from the list that will execute when exiting the remote server.

7. Administration

An explanation of the configuration fields is provided in the table below:

Field	Explanation
Port OS	Specifies the operating system that the server on the connected port is using. Choices are Win, Mac, Sun, and Other. The default is Win.
OS Language	Specifies the OS language being used by the server on the connected port. Use the drop down to see the available choices. The default is English US.
Cable Length	Specifies the length of the Cat5e/6 cable that is used to connect the server to the port. Choices are Short (less than 33 ft./10 m), Medium (33-82 ft./10-25 m), and Long (greater than 82 ft./25 m). The default is Short. Note: Cable length can affect video quality. Shorter cables offer better quality. This setting is designed to compensate for longer or shorter cable lengths. You can experiment to find the setting that best suits your connection.
Access Mode	Defines how the port is to be accessed when multiple users have logged on: Exclusive: The first user to switch to the port has exclusive control over the port. No other users can view the port. The <i>Timeout</i> function does not apply to ports which have this setting. Occupy: The first user to switch to the port has control over the port. However, additional users may view the port's video display. If the user who controls the port is inactive for longer than the time set in the <i>Timeout</i> box, port control is transferred to the first user to move the mouse or strike the keyboard. Share: Users simultaneously share control over the port. Input from the users is placed in a queue and executed chronologically.
Exit Macro	The <i>Exit Macro</i> panel contains a drop-down list box of user created System macros. You can select a macro from the list that will execute when exiting the remote server.

7.7.9 Associated Link

The *Associated Links* page provides a method of associating other ports on the same switch to the selected port. This function is primarily intended to be used when connecting both KVM and serial ports from a single server to the switch.

- To associate a port with the currently selected one, click **Add**. In the dialog box that appears, key in the port's number, then click **OK**. The port's number and name appear in the main panel.
- To remove an unwanted associated port, select it in the main panel, then click **Remove**.

7.7.10 Occupy Timeout

When a switch is selected in the sidebar, the *Occupy Timeout* setting appear when Port Configuration is selected on the menu bar:

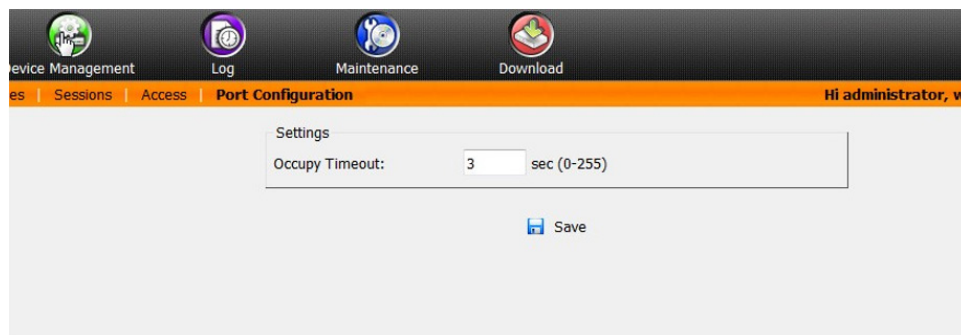

Use *Occupy Timeout Mode* to set a time threshold for users on ports whose Operation Mode has been set to Occupy (see **7.7.8 Port Configuration**). If there is no activity from the user occupying the port for the amount of time set here, the user is timed out and keyboard and mouse control on the port is released, after which the first user to send keyboard or mouse input will occupy the port. However, the user originally connected to the port will still see the port's video output.

Input a value from 0 to 255 seconds. The default is 3 seconds. A setting of 0 causes the port to be released the instant there is no input.

7. Administration

7.8 User Management

When you select the *User Management* tab the screen opens with the *Users* page displayed:

Browser GUI

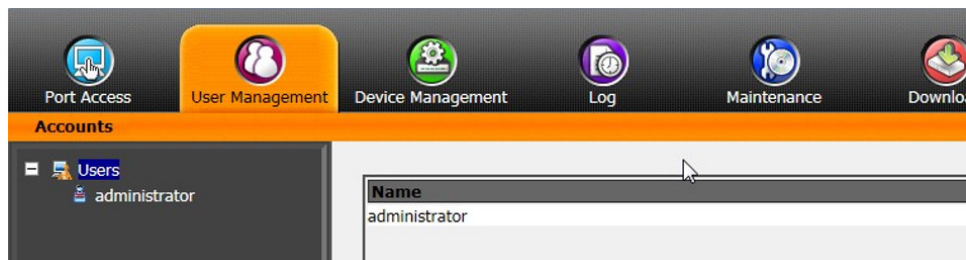

AP GUI

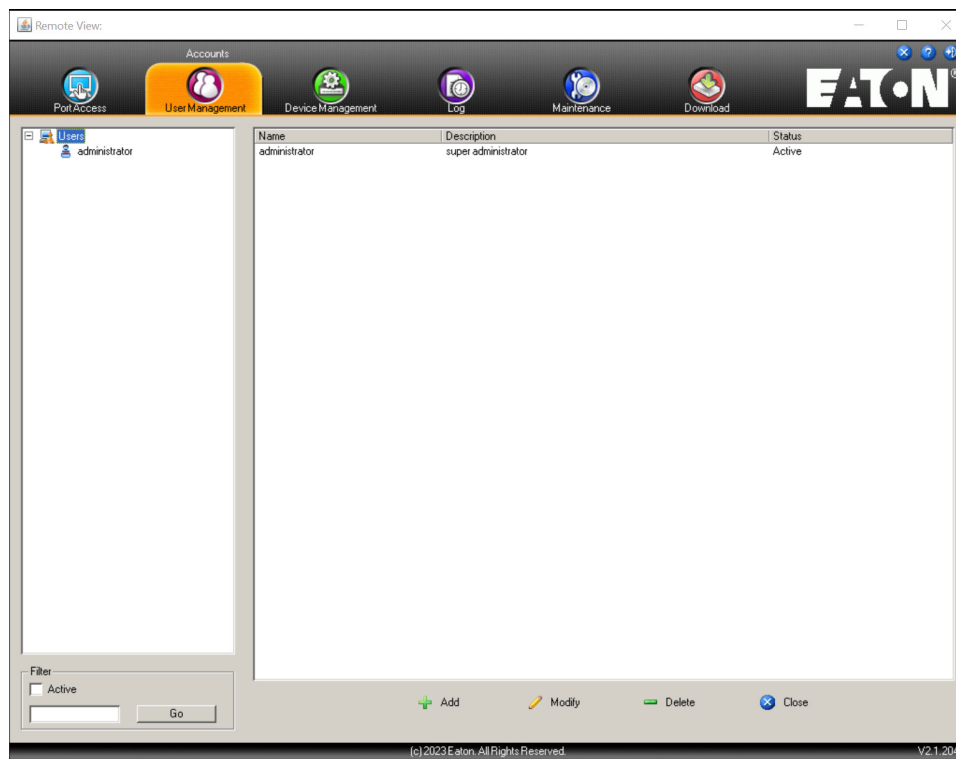

- Users appear in the panel on the left of the page. The large panel at the right provides more detailed information.
- The buttons below the main panel are used to manage users.

7. Administration

7.8.1 Users

The B064C-16-1-IP supports three types of user accounts:

User Type	Role
Super Administrator	Access and manage ports and devices. Manage Users. Configure the overall installation. Configure personal working environment.
Administrator	Access and manage authorized ports and devices. Manage Users. Configure personal working environment.
User	Access authorized ports and devices. Manage authorized ports and devices. Configure personal working environment. Note: Users who have been given permission to do so may also manage other users.

Adding Users

To add a user and assign user permissions:

1. Select *Users* in the Sidebar (Browser GUI)

- or -

Select *Users* in the Sidebar (AP GUI).

2. To add a user, click **Add** at the bottom of the main panel. The User notebook opens, with the *User* tab selected:

The screenshot displays the Eaton User Management web interface. The top navigation bar includes icons for Port Access, User Management (highlighted), Device Management, Log, Maintenance, and Download, along with the Eaton logo. The left sidebar shows 'Accounts' with 'Users' and 'administrator' listed. The main content area is titled 'User' and contains a 'User Information' form. The form includes fields for Username, Password, Confirm Password, and Description. The 'Role' section has radio buttons for Super Administrator, Administrator, and User (selected). The 'Permissions' section has checkboxes for Device Management, Maintenance, Windows Client (checked), Port Configuration, System Log, Java Client (checked), User Management, View only, and Force to Grayscale. The 'Status' section has checkboxes for Disable account, Account never expires (selected), Account expires on, User must change password at next logon, User cannot change password, Password never expires (selected), and Password expires after (with a '0' days input field). A 'Save' button is located at the bottom right of the form. The footer contains the text '(c) 2023 Eaton. All Rights Reserved.'

7. Administration

3. Enter the required information in the appropriate fields. A description of each of the fields is given in the table below:

Field	Description
Username	Enter a username with a minimum of 6 and maximum of 16 characters.
Password	Enter a password with a minimum of 6 and maximum of 16 characters.
Confirm Password	To ensure there is no mistake in the password, you will be asked to enter it again. The two entries must match.
Description	Additional information about the user that you may wish to include.
Role	<p>There are three categories: <i>Super Administrator</i>, <i>Administrator</i> and <i>User</i>. There is no limitation on the number of accounts that can be created in each category.</p> <ul style="list-style-type: none"> The <i>Super Administrator</i> is responsible for the overall installation configuration and maintenance, user management and device and port assignments. The Super Administrator's permissions are automatically assigned by the system and cannot be altered. The default permissions for <i>Administrators</i> include everything except Force to Grayscale, but the permissions can be altered for each Administrator by checking or unchecking any of the permissions checkboxes. The default permissions for <i>Users</i> include the Win, Java, and SSH clients, but the permissions can be altered for each User by checking or unchecking any of the permissions checkboxes. <p>Note: <i>Users who have been given User Management privileges cannot access or configure Groups.</i></p>
Permissions	<ul style="list-style-type: none"> Enabling <i>Device Management</i> allows a user to configure and control the settings for overall operations (see 7.9 Device Management). Enabling <i>Maintenance</i> allows a user to perform all the Maintenance operations available under the Maintenance tab (see 7.11 Maintenance). Enabling <i>Windows Client</i> allows a user to download the Windows Client AP software, and access the B064C-16-1-IP with it, in addition to (or instead of) the browser access method. Enabling <i>Port Configuration</i> allows a user to configure and control the settings for individual ports (see 7.7.8 Port Configuration). Enabling <i>System Log</i> allows a user to access the system log (see 7.10 Log). Enabling <i>Java Client</i> allows a user to download the Java Client AP software and access the B064C-16-1-IP with it, in addition to (or instead of) the browser access method. Enabling <i>User Management</i> allows a user to create, modify and delete user and group accounts. Enabling <i>View Only</i> limits users to only being able to view the display of connected devices. They cannot control port access, nor can they input any keyboard or mouse signals to the devices they view. <i>Force to Grayscale</i> forces the user's view of the remote display to be in grayscale. This can speed up I/O transfer in low bandwidth situations.

Note: For ordinary users, in addition to enabling *Device Management*, *Port Configuration*, and *Maintenance* permissions, the user must also be given those rights for each device and port that he will be allowed to manage. See **7.8.2 Device Assignment** for details.

7. Administration

Field	Description
Status	<p>Status allows you to control the user's account and access the installation.</p> <ul style="list-style-type: none">• <i>Disable Account</i> lets you suspend a user's account without actually deleting it, so that it can be easily reinstated in the future.• If you do not want to limit the time scope of the account, select <i>Account never expires</i>; if you do want to limit the amount of time that the account remains in effect, select <i>Account expires on</i> and key in the expiration date.• To require a user to change his password at the next logon, select <i>User must change password at next logon</i>. This can be used by the administrator to give the user a temporary password to log in for the first time, then let the user set the password of their choice for future logins.• To make a password permanent so the user cannot change it to something else, select <i>User cannot change password</i>.• For security purposes, administrators may want users to change their passwords periodically.<ul style="list-style-type: none">o If not, select <i>Password never expires</i>. This allows users to keep their current passwords for as long as they like.o If so, select <i>Password expires after</i>, and key in the number of days allowed before the password expires. Once the time is up, a new password must be set.

4. When your selections have been made click **Save**.
5. When the *Operation Succeeded* message appears, click **OK**.
6. Click **Users** in the Sidebar to return to the main screen. The new user will in the Sidebar list and in the main panel.
 - o The *Sidebar Users* list can expand and collapse. If the list is expanded, click the minus symbol (-) next to the *Users* icon to collapse it; if it is collapsed there is a plus symbol (+) next to the icon. Click the plus symbol to expand it.
 - o The icon for administrators has one red band.
 - o The large main panel shows the user's name; the description that was given when the account was created and whether the account is currently active or has been disabled.

Modifying User Accounts

To modify a user account:

1. In the *Sidebar User* list, click the user's name
 - or -
 - In the main panel, select the user's name
2. Click **Modify**.
3. In the *User* page that opens, make your changes, then click **Save**.

Deleting User Accounts

To delete a user account:

1. In the main panel, select the user's name.
2. Click **Delete**.
3. Click **OK**.

7. Administration

7.8.2 Device Assignment

When a user logs in to the B064C-16-1-IP, the interface opens with the *Port Access* page displayed. All the ports the user is permitted to access are listed in the Sidebar on the left of the page. Access permissions for those ports and the devices connected to them are assigned on a port-by-port basis from the User list on the Sidebar of the *User Management* page.

Note: When a Super Administrator account is selected, you will not be able to select the Devices tab since these accounts have full permissions and they cannot be change.

Assigning Device Permissions from the User's Notebook

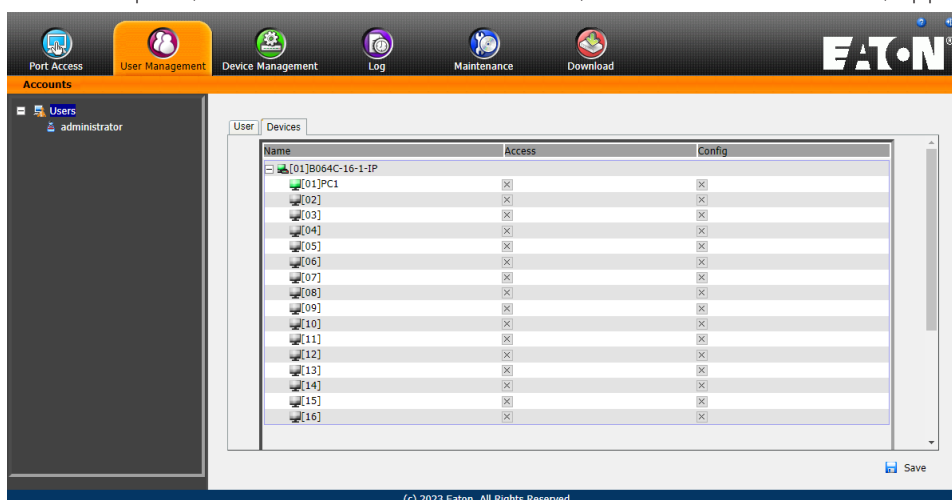

- In the *Sidebar User* list, click the user's name
- or -
In the main panel, select the user's name.
- Click **Modify**.
- In the *User* notebook that opens, select the *Devices* tab. A screen, similar to the one below, appears:



- Make your permission settings for each port according to the information provided below:

Name: Each port accessible to the user is listed under the *Names* column.

Access: The *Access* column is where device access rights are set. Click the icon in the row that corresponds to the port you want to configure to cycle through the choices. The meanings of the icons are described in the table below:

	Full Access	The user can view the remote screen and perform operations on the remote server from his keyboard and monitor.
	View Only	The user can only view the remote screen and cannot perform any operations on it.
	No Access	No access rights - the Port will not appear on the User's list on the Main Screen.

- Once you have finished making your choices, click **Save**.
- In the confirmation popup that appears, click **OK**.

Note: In any of the columns, you can use *Shift-Click* or *Ctrl-Click* to select a group of ports to configure. Clicking to cycle through the choices on any one of the selected ports will all to cycle in unison.

7. Administration

7.9 Device Management

7.9.1 KVM Devices

Device Information

The *Device Management* page opens with the top level B064C-16-1-IP selected in the Sidebar and the *Device Configuration* item selected on the menu bar:

Browser GUI

The screenshot displays the Eaton Device Management web interface. The top navigation bar includes icons for Port Access, User Management, Device Management (highlighted), Log, Maintenance, and Download. Below this is a secondary menu with tabs for Device Information, Operating Mode, Network, ANMS, Security, and Date/Time. The left sidebar shows a tree view with 'B064C-16-1-IP' selected. The main content area shows the 'General' configuration for this device:

General	
Device Name:	B064C-16-1-IP
MAC Address:	00-06-67-08-27-20
Firmware Version:	V2.1.201 Build20230728
IP Address:	10.3.166.208
Subnet Mask:	255.255.254.0
Gateway:	10.3.167.254
Preferred DNS Server:	10.3.167.250
Alternate DNS Server:	10.3.152.2
IPv6 Address:	FE80:0:0:206:67FF:FE08:2720
IPv6 Subnet Prefix Length:	0

At the bottom right of the configuration area are 'Save' and 'Close' buttons. The footer contains the copyright notice '(c) 2023 Eaton. All Rights Reserved.'

AP GUI

The screenshot displays the Eaton AP GUI. The top navigation bar is identical to the previous screenshot. The secondary menu has tabs for Device Information, Operating Mode, Network, ANMS, Security, and Date/Time. The left sidebar shows a tree view with 'B020-U16-19-IP' selected. The main content area shows the 'General' configuration for this device:

General	
Device Name:	B020-U16-19-IP
MAC Address:	00-06-67-00-0a-11
Firmware Version:	V2.1.204 Build20230630
IP Address:	172.17.18.194
Subnet Mask:	255.255.255.0
Gateway:	172.17.18.254
IPv6 Address:	FE80:0:0:206:67FF:FE00:A1F
IPv6 Subnet Prefix Length:	0

At the bottom right of the configuration area are 'Save' and 'Close' buttons. The footer contains the copyright notice '(c) 2023 Eaton. All Rights Reserved.' and the version number 'V2.1.204'.

7. Administration

7.9.2 Operating Mode

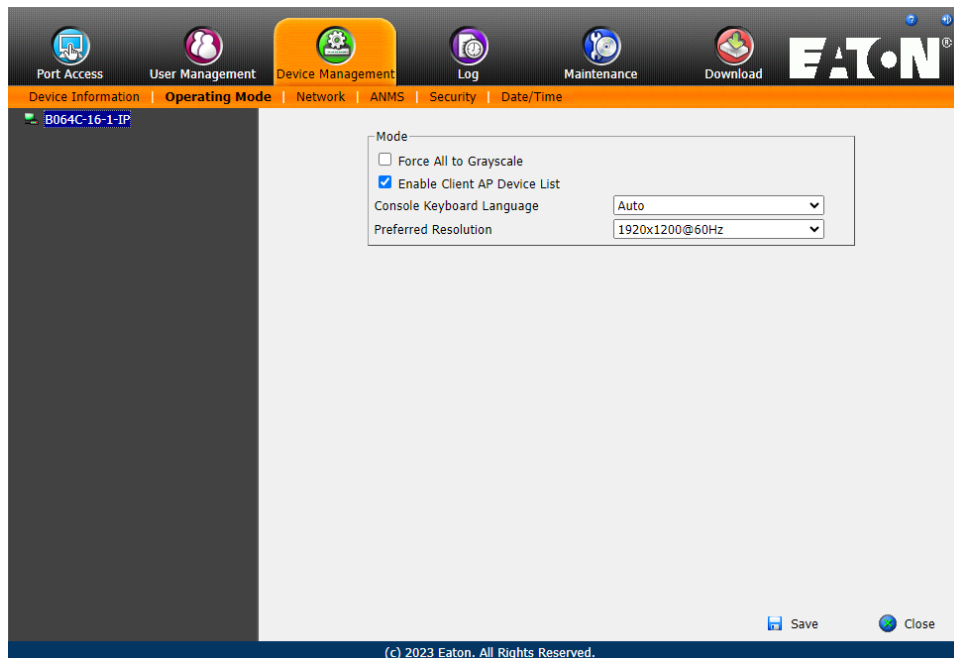

The *Operating Mode* page is used to set working parameters.

- If *Force all to grayscale* is enabled, the remote displays of all devices connected to the B064C-16-1-IP are changed to grayscale. This can speed up I/O transfer in low bandwidth situations.
- If *Enable Client AP Device List* is enabled, the switch appears in the Server List when using the WinClient or Java Client AP (see **7.5.3 Windows Client AP Login** and **7.5.4 Java Client AP Login**). If this option is not enabled, the switch can still be connected but its name will not appear in the Server List.
- The *Console Keyboard Language* setting lets you specify which keyboard mapping is being used by the Local Console keyboard. Use the drop down list to make your choice.
- *Preferred Resolution* allows you to set a resolution that the switch sends to the KVM adapter cables. The adapter cables provide the connected computer's video card information about the monitor connected to the switch. This affects the video quality of the console monitor.
 - o *Monitor Default Setting*: Sends the EDID information provided by the display connected to the console port to the KVM adapter cable.

7. Administration

7.9.3 Network

The *Network* page is used to specify the network environment.

IP Installer		
<input checked="" type="radio"/> Enabled	<input type="radio"/> View Only	<input type="radio"/> Disabled
Service Ports		
Program:	<input type="text" value="9000"/>	
HTTP:	<input type="text" value="80"/>	
HTTPS:	<input type="text" value="443"/>	
IPv4 Settings		
IP Address:		
<input checked="" type="radio"/> Obtain IP address automatically [DHCP]		
<input type="radio"/> Set IP address manually [Fixed IP]		
IP Address:	<input type="text" value="10.3.166.155"/>	
Subnet Mask:	<input type="text" value="255.255.254.0"/>	
Default Gateway:	<input type="text" value="192.168.10.30"/>	
DNS Server:		
<input checked="" type="radio"/> Obtain DNS server address automatically		
<input type="radio"/> Set DNS server address manually		
Preferred DNS server:	<input type="text" value="0.0.0.0"/>	
Alternate DNS server:	<input type="text" value="0.0.0.0"/>	
IPv6 Settings		
IP Address:		
<input checked="" type="radio"/> Obtain IPv6 address automatically [DHCP]		
<input type="radio"/> Set IPv6 address manually [Fixed IP]		
IPv6 Address:	<input type="text"/>	
Subnet Prefix Length:	<input type="text" value="64"/>	
Default Gateway:	<input type="text"/>	
DNS Server:		
<input checked="" type="radio"/> Obtain DNS server address automatically		
<input type="radio"/> Set DNS server address manually		
Preferred DNS server:	<input type="text"/>	
Alternate DNS server:	<input type="text"/>	
Network Transfer Rate:	<input type="text" value="99999"/> KBps	

7. Administration

IP Installer

The *IP Installer* is an external Windows-based utility for assigning IP addresses to the B064C-16-1-IP.

Click one of the radio buttons to select *Enable*, *View Only* or *Disable* for the IP Installer utility.

Notes:

- If you select *View Only*, you will be able to see the B064C-16-1-IP in the IP Installer's Device List, but you will not be able to change the IP address.
- For security, we strongly recommend you set this to *View Only* or *Disable* after each use.

Service Ports

As a security measure, if a firewall is being used the Administrator can specify the port numbers that the firewall will allow. If a port other than the default is used, users must specify the port number as part of the IP address when they log in. If an invalid port number (or no port number) is specified, the B064C-16-1-IP will not be found. An explanation of the fields is provided in the table below:

Field	Explanation
Program	This is the port number for connecting with the WinClient ActiveX Viewer, WinClient AP, Java Applet Viewer or Java Client AP. The default is 9000.
HTTP	The port number for a browser login. The default is 80.
HTTPS	The port number for a secure browser login. The default is 443.

Notes:

- Valid entries for all the Service Ports are from 1-65535.
- Service ports cannot have the same value. You must set a different value for each one.
- If there is no firewall (on an Intranet, for example), it does not matter what these numbers are set to, as they have no effect.

Network Configuration

• IPv4 Settings

o IP Address:

IPv4 is the traditional method of specifying IP addresses. The KVM switch can have its IP address assigned dynamically (DHCP) or it can be given a fixed IP address.

- o For dynamic IP address assignment, select the *Obtain IP address automatically* radio button (this is the default setting).
- o To specify a fixed IP address, select the *Set IP address manually* radio button and fill in the fields with values appropriate for your network.

Note: If the switch is on a network that uses DHCP to assign network addresses, and you need to ascertain its IP address, see **7.1 IP Address Determination** for details.

• DNS Server

- o For automatic DNS Server address assignment, select the *Obtain DNS Server address automatically* radio button.
- o To specify the DNS Server address manually, select the *Set DNS server address manually* radio button and fill in the addresses for the Preferred and Alternate DNS servers with values appropriate for your network.

Note: Specifying the Alternate DNS Server address is optional.

• IPv6 Settings

o IP Address:

IPv6 is the new (128-bit) format for specifying IP addresses. The KVM switch can either have its IPv6 address assigned dynamically (DHCP), or it can be given a fixed IP address.

- o For dynamic IP address assignment, select the *Obtain IP address automatically* radio button. (This is the default setting.)
- o To specify a fixed IP address, select the *Set IP address manually* radio button and fill in the fields with values appropriate for your network.

7. Administration

- DNS Server
 - o For automatic DNS Server address assignment, select the *Obtain DNS Server address automatically* radio button.
 - o To specify the DNS Server address manually, select the *Set DNS server address manually* radio button, and fill in the addresses for the Preferred and Alternate DNS servers with values appropriate for your network.

Note: *Specifying the Alternate DNS Server address is optional.*

Network Transfer Rate

This setting allows you to tailor the size of the data transfer stream to match network traffic conditions by setting the rate at which the KVM over IP switch transfers data between itself and the client computers. The range is from 4- 99999 Kilobytes per second (KBps).

7.9.4 ANMS

The *ANMS* (Advanced Network Management Settings) page is used to set up login authentication and authorization management from external sources.

Event Destination

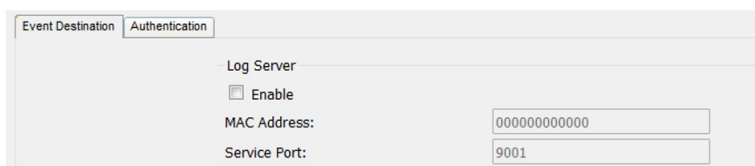

The screenshot shows a configuration window with two tabs: "Event Destination" and "Authentication". The "Event Destination" tab is active. Under the heading "Log Server", there is a checked checkbox labeled "Enable". Below this, there are two input fields: "MAC Address:" with the value "000000000000" and "Service Port:" with the value "9001".

- Log Server
 - When *Enable Log Server* is checked, important transactions that occur on the B064C-16-1-IP, such as logins and internal status messages, are kept in an automatically generated log file.
 - o Specify the MAC address of the computer that the Log Server runs on in the *MAC address* field.
 - o Specify the service port used by the computer that the Log Server runs on to listen for log details in the *Port* field. The valid port range is 1- 65535. The default port number is 9001.

Notes:

- *The port number must be different than the one used for the Program port.*
- See **7.14 The Log Server** for details on setting up the log server.

7. Administration

Authentication and Authorization

RADIUS Settings

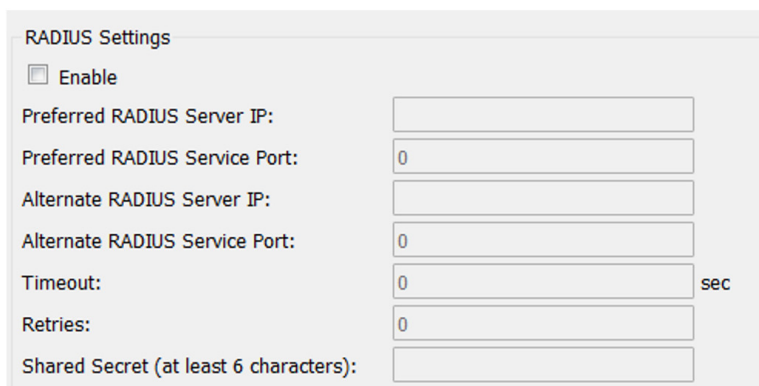

RADIUS Settings

Enable

Preferred RADIUS Server IP:

Preferred RADIUS Service Port:

Alternate RADIUS Server IP:

Alternate RADIUS Service Port:

Timeout: sec

Retries:

Shared Secret (at least 6 characters):

To allow authentication and authorization for the B064C-16-1-IP through a RADIUS server, do the following:

1. Check **Enable**.
2. Fill in the IP addresses and service port numbers for the Preferred and Alternate RADIUS servers. You can use the IPv4 address, the IPv6 address or the domain name in the IP fields.
3. In the *Timeout* field, set the time in seconds that the B064C-16-1-IP waits for a RADIUS server reply before it times out.
4. In the *Retries* field, set the number of allowed RADIUS retries.
5. In the *Shared Secret* field, key in the character string that you want to use for authentication between the B064C-16-1-IP and the RADIUS Server. A minimum of 6 characters is required.
6. On the RADIUS server, Users can be authenticated with any of the following methods:
 - o Set the entry for the user as su/xxxx
 - o Where xxxx represents the Username given to the user when the account was created on the B064C-16-1-IP.
 - o Use the same Username on both the RADIUS server and the B064C-16-1-IP.

7. Administration

LDAP / LDAPS Authentication and Authorization Settings

To allow authentication and authorization via LDAP or LDAPS, the Active Directory's LDAP Schema must be extended so that an extended attribute name for the B064C-16-1-IP - *iKVM36-userProfile* is added as an optional attribute to the person class.

To manually determine the attribute name of the B064C-16-1-IP - *iKVM36-userProfile*, go to *Ping Host* under *Maintenance* and execute a **tc get** command (see **7.11.5 Ping Host** for details).

To configure the LDAP server, you will need to complete the following:

1. Install the Windows Server Support Tools.
2. Install the Active Directory Schema Snap-in.
3. Extend and Update the Active Directory Schema.

The screenshot shows a configuration window titled "AD/LDAP Settings". It contains the following elements:

- An "Enable" checkbox.
- A "Type" section with two radio buttons: "LDAP" (which is selected) and "LDAPS".
- Input fields for "LDAP Server:", "Port:", "Admin DN:", "Admin Name:", "Password:", and "Search DN:". The "Port:" field has a value of "0" and is followed by "sec".
- A "Timeout:" field with a value of "0" and "sec" next to it.

To allow authentication and authorization for the B064C-16-1-IP via LDAP / LDAPS, refer to the information in the table below:

Item	Action
Enable	Put a check in the <i>Enable</i> checkbox to allow LDAP / LDAPS authentication and authorization.
Type	Click a radio button to specify whether to use LDAP or LDAPS.
LDAP Server IP and Port	Fill in the IP address and port number for the LDAP or LDAPS server. <ul style="list-style-type: none">• You can use the IPv4 address, the IPv6 address or the domain name in the <i>LDAP Server</i> field.• For LDAP, the default port number is 389; for LDAPS, the default port number is 636.
Timeout	Set the time in seconds that the B064C-16-1-IP waits for an LDAP or LDAPS server reply before it times out.
Admin DN	Consult the LDAP / LDAPS administrator to ascertain the appropriate entry for this field. For example, the entry might look like this: <code>ou=B064C161IP,dc=eaton,dc=com</code>
Admin Name	Key in the LDAP administrator's username.
Password	Key in the LDAP administrator's password.
Search DN	Set the distinguished name of the search base. This is the domain name where the search starts for user names.

On the LDAP / LDAPS server, Users can be authenticated with an MS Active Directory schema.

7. Administration

7.9.5 Security

The *Security* page is divided into six main panels.

Login Failures

For increased security, the Login Failures section allows administrators to set policies governing what happens when a user fails to log in successfully.

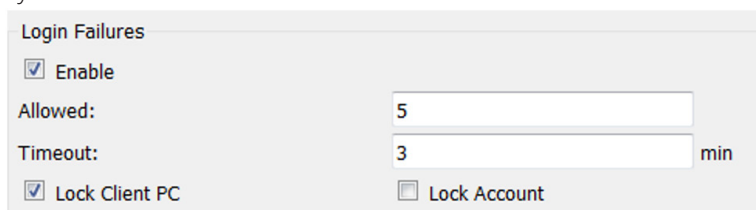

Login Failures

Enable

Allowed:

Timeout: min

Lock Client PC Lock Account

To set the Login Failures policy, check the *Enable* checkbox (the default is for Login Failures to be enabled). The entries are explained in the table below:

Entry	Explanation
Allowed	Sets the number of consecutive failed login attempts that are permitted from a remote computer. The default is 5 times.
Timeout	Sets the amount of time a remote computer must wait before attempting to login again after it has exceeded the number of allowed failures. The default is 3 minutes.
Lock Client PC	If this is enabled, after the allowed number of failures have been exceeded the computer attempting to log in from that IP is automatically locked out. No logins from that computer will be accepted. The default is enabled. Note: <i>If the IP is changed, the computer will no longer be locked out.</i>
Lock Account	If this is enabled, after the allowed number of failures have been exceeded, the user attempting to log in is automatically locked out. No logins from the username and password that have failed will be accepted. The default is enabled.

Note: *If Login Failures is not enabled, users can attempt to log in an unlimited number of times with no restrictions. For security purposes, we recommend you enable this function and enable the lockout policies.*

7. Administration

Filter

The screenshot shows a configuration window titled "Filter". It is divided into two main sections: "IP Filter" and "MAC Filter".

- IP Filter Section:**
 - Checkbox: Enable IP Filter
 - Radio buttons: Include, Exclude
 - List box: An empty list box with a vertical scrollbar.
 - Buttons: Add, Modify, Delete
- Login String Section:**
 - Text field: A single-line text input field.
- MAC Filter Section:**
 - Checkbox: Enable MAC Filter
 - Radio buttons: Include, Exclude
 - List box: An empty list box with a vertical scrollbar.
 - Buttons: Add, Modify, Delete

- IP and MAC Filtering

IP and MAC Filters control access to the B064C-16-1-IP based on the IP and/or MAC addresses of the client computers attempting to connect. A maximum of 100 IP filters and 100 MAC filters are allowed. If any filters have been configured, they appear in the IP Filter and/or MAC Filter list boxes.

To enable IP and/or MAC filtering, Click to put a check mark in the *IP Filter Enable* and/or *MAC Filter Enable* checkbox.

- If the include button is checked, all the addresses within the filter range are allowed access; all other addresses are denied access.
 - If the exclude button is checked, all the addresses within the filter range are denied access; all other addresses are allowed access.
- Adding Filters

To add an IP filter:

1. Click **Add**. A script prompt dialog box appears.
2. Specify whether you are filtering an IPv4 or IPv6 address.
3. Key the address you want to filter in the *From:* field.
 - o To filter a single IP address, click to put a check in the *Single IP* checkbox.
 - o To filter a continuous range of addresses, key in the end number of the range in the *To:* field.

Note: This description is for the AP GUI. The Browser GUI differs as follows:

- It does not offer an IPv4 or IPv6 choice. It only has *From* and *To* fields for IPv4 filtering.
 - It does not have a checkbox to specify a single IP address. To filter a single IPv4 address, key the same address in both the *From* and *To* fields.
4. After filling in the address, click **OK**.
 5. Repeat these steps for any additional IP addresses you want to filter.

7. Administration

To add a MAC filter:

1. Click **Add**. A script prompt dialog box.
 2. Specify the MAC address in the dialog box, then click **OK**.
 3. Repeat these steps for any additional MAC addresses you want to filter.
- IP Filter / MAC Filter Conflict

If there is a conflict between an IP filter and a MAC filter (e.g., if a computer's address is allowed by one filter but blocked by the other), then the blocking filter takes precedence (the computer's access is blocked).

- Modifying Filters

To modify a filter, select it in the IP Filter or MAC Filter list boxes and click **Modify**. The Modify dialog box is similar to the Add dialog box. When it opens, simply delete the old address(es) and replace with the new one(s).

- Deleting Filters

To delete a filter, select it in the IP Filter or MAC Filter list box and click **Delete**.

Login String

The *Login String* entry field lets the super administrator specify a login string (in addition to the IP address) that users must add to the IP address when they access the B064C-16-1-IP with a browser.

For example, if *192.168.0.126* were the IP address, and *abcdefg* were the login string, then the user would key in:

192.168.0.126/abcdefg

Notes:

- Users must place a forward slash between the IP address and the string.
- If no login string is specified here, anyone will be able to access the B064C-16-1-IP login page using the IP address alone. This makes your installation less secure.

The following characters are allowed in the string: 0-9 a-z A-Z ~ ! @ \$ & * () _ - = + [] , . |

The following characters are not allowed:

% ^ " : / ? # \ ' { } ; ' < > [Space]

Compound characters (E < fi ... etc.)

The following examples are not allowed:

192.168.0.126/.

192.168.0.126/..

192.168.0.126/...

For security purposes, we recommend you change this string occasionally.

Account Policy

In the *Account Policy* section, administrators can set policies governing usernames and passwords.

Account Policy	
Minimum Username Length:	<input type="text" value="6"/>
Minimum Password Length:	<input type="text" value="6"/>
Password Must Contain At Least	<input type="checkbox"/> One Upper Case
	<input type="checkbox"/> One Lower Case
	<input type="checkbox"/> One Number
<input type="checkbox"/> Enforce Password History	<input type="text" value="3"/>

7. Administration

The meanings of the Account Policy entries are explained in the table below:

Entry	Explanation
Minimum Username Length	Sets the minimum number of characters required for a username. Acceptable values are from 1-16. The default is 6.
Minimum Password Length	Sets the minimum number of characters required for a password. Acceptable values are from 0-16. A setting of 0 means that no password is required. Users can login with only a Username. The default is 6.
Password Must Contain At Least	Checking any of these items requires users to include at least one uppercase letter, one lowercase letter or one number in their password. Note: <i>This policy only affects user accounts created after this policy has been enabled and password changes to existing user accounts. Users accounts created before this policy was enabled and there is no change to the existing passwords are not affected.</i>
Enforce Password History	Checking this box will require users to create a unique password that does not match the last x passwords they've used prior. X equals the number entered in the dialog box.

Encryption

These flexible encryption alternatives for keyboard/mouse and video let you choose any combination of DES; 3DES; AES; RC4; or a Random cycle of any or all of them.

Enabling encryption affects system performance and no encryption offers the best performance. The greater the encryption, the greater the adverse effect. If you enable encryption, the performance considerations are as follows:

- RC4 offers the least impact on performance; DES is next; followed by 3DES or AES.
- The RC4 + DES combination offers the least impact of any combination.

Mode

An explanation of the Mode items is provided in the table, below:

Item	Explanation
Enable ICMP	If <i>ICMP</i> is enabled , the B064C-16-1-IP can be pinged. If it is not enabled, the device cannot be pinged. The default is Enabled.
Enable Multiuser Operation	Enabling <i>Multiuser</i> operation permits up to 32 users to log in at the same time to share the remote bus. If not enabled, only one user can log in at a time. The default is Enabled.
Enable Browser	Enabling Browser Service allows the administrator to restrict browser access to the KVM over IP switch. After checking Browser Service, use the drop down list to select the degree of restriction: Disable Browser: No browser access is permitted. Disable HTTP: Browser access is permitted, but users must access the switch with an HTTPS URL. Disable HTTPS: Browser access is permitted, but users must access the switch with an HTTP URL.

7. Administration

Private Certificate

When logging in over a secure (SSL) connection, a signed certificate is used to verify that the user is logging in to the intended site. For enhanced security, the *Private Certificate* section allows you to use your own private encryption key and signed certificate, rather than the default certificate.

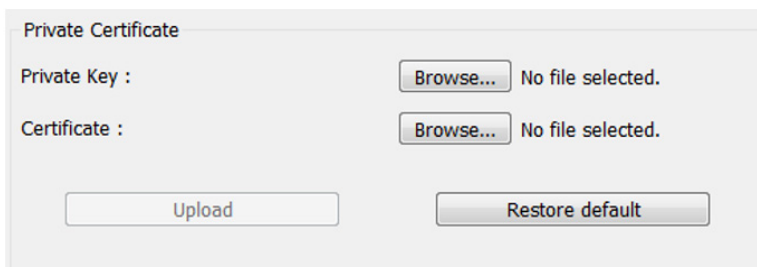

The screenshot shows a form titled "Private Certificate". It contains two rows of input fields. The first row is labeled "Private Key :" and has a "Browse..." button followed by the text "No file selected.". The second row is labeled "Certificate :" and also has a "Browse..." button followed by "No file selected.". At the bottom of the form, there are two buttons: "Upload" and "Restore default".

There are two methods for establishing your private certificate: generating a self-signed certificate and importing a third-party certificate authority (CA) signed certificate.

- Generating a Self-Signed Certificate

If you wish to create your own self-signed certificate, a free utility - openssl.exe - is available for download over the web. See **7.1.3 Self-Signed Private Certificates** for details about using OpenSSL to generate your own private key and SSL certificate.

- Obtaining a CA Signed SSL Server Certificate

For the greatest security, we recommend using a third-party certificate authority (CA) signed certificate. To obtain a third-party signed certificate, go to a CA (Certificate Authority) website to apply for an SSL certificate. After the CA sends you the certificate and private encryption key, save them to a convenient location on your computer.

- Importing the Private Certificate

1. Click **Browse** to the right of *Private Key*, then browse to where your private encryption key file is located and select it.
2. Click **Browse** to the right of *Certificate*, then browse to where your certificate file is located and select it.
3. Click **Upload** to complete the procedure.

Notes:

Clicking **Restore Default** returns the device to using the default certificate.

Both the private encryption key and the signed certificate must be imported at the same time.

Certificate Signing Request

The *Certificate Signing Request* (CSR) section provides an automated way of obtaining and installing a CA signed SSL server certificate.

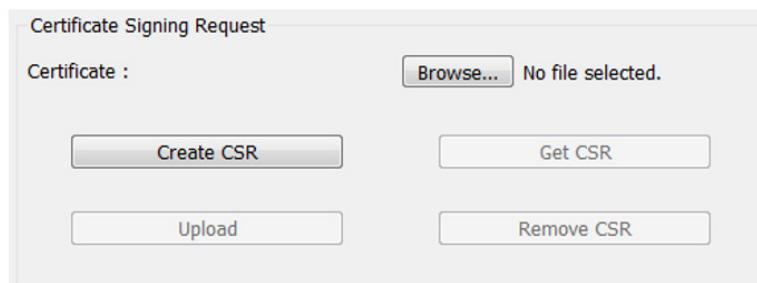

The screenshot shows a form titled "Certificate Signing Request". It contains a "Certificate :" label with a "Browse..." button and "No file selected." text. Below this, there are four buttons arranged in a 2x2 grid: "Create CSR" (top-left), "Get CSR" (top-right), "Upload" (bottom-left), and "Remove CSR" (bottom-right).

7. Administration

To perform this operation:

1. Click **Create CSR**. The following dialog box appears:

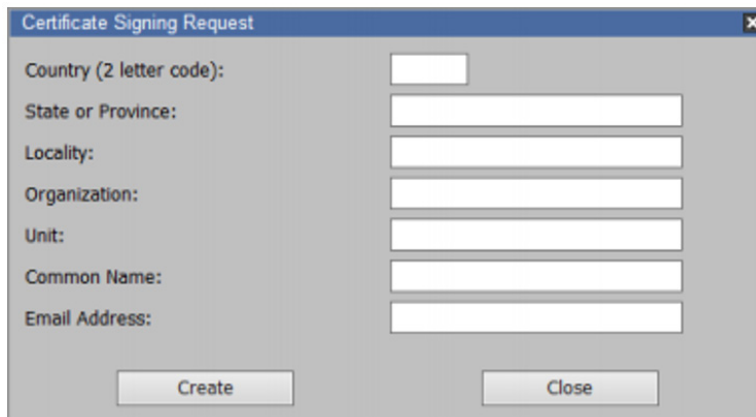

The image shows a dialog box titled "Certificate Signing Request" with a close button (X) in the top right corner. It contains seven text input fields, each with a label to its left: "Country (2 letter code)", "State or Province", "Locality", "Organization", "Unit", "Common Name", and "Email Address". At the bottom of the dialog, there are two buttons: "Create" on the left and "Close" on the right.

2. Fill in the form with entries that are valid for your site.

Information	Example
Country (2 letter code)	US
State or Providence	USA Eaton State (i.e. IL)
Locality	USA
Organization	Your Company, Ltd.
Common Name	mycompany.com Note: This must be the exact domain name of the site that you want the certificate to be valid for. If the site's domain name is www.mycompany.com, and you only specify mycompany.com, the certificate will not be valid.
E-mail Address	administrator@yourcompany.com

3. After filling in the form (all fields are required), click **Create**.

A self-signed certificate based on the information you just provided is now stored on the KVM over IP switch.

4. Click **Get CSR** and save the certificate file (csr.cer) to a convenient location on your computer.

This is the file that you give to the third-party CA to apply for their signed SSL certificate.

5. After the CA sends you the certificate, save it to a convenient location on your computer. Click **Browse** to locate the file, then click **Upload** to store it on the KVM over IP switch.

Note: When you upload the file, the KVM over IP switch checks the file to make sure the specified information still matches. If it does, the file is accepted; if not, it is rejected.

If you want to remove the certificate (to replace it with a new one because of a domain name change, for example), simply click **Remove CSR**.

7. Administration

7.9.6 Date/Time

The *Date/Time* dialog page sets the B064C-16-1-IP time parameters.

Time Zone

(GMT-12:00) Eniwetok Kwajalein

Daylight Savings Time

Date

February < 2018 >

February 2018

Su	Mo	Tu	We	Th	Fr	Sa
				1	2	3
4	5	6	7	8	9	10
11	12	13	14	15	16	17
18	19	20	21	22	23	24
25	26	27	28			

Time

10 : 02 : 08 Set

Network Time

Enable auto adjustment

Preferred time server

AU | ntp1.cs.mu.OZ.AU

Preferred custom server IP

Alternate time server

AU | ntp1.cs.mu.OZ.AU

Alternate custom server IP

Adjust time every 1 days Adjust Time Now

Time Zone

- To establish the time zone that the B064C-16-1-IP is located in, drop down the *Time Zone* list and choose the city that most closely corresponds to where it is at.
- If Daylight Savings Time (summer time) is currently in effect, check the corresponding checkbox. After the period of Daylight Savings Time ends (winter time), the checkbox should be unchecked.

Date

- Select the month from the dropdown list.
- Click < or > to move backward or forward by one year increments.
- In the calendar, click on the day.
- To set the time, use the 24 hour HH:MM:SS format.
- Click **Set** to save your settings.

7. Administration

Time

To manually set the time, enter the values in the boxes and click **Set**.

Network Time

To have the time automatically synchronized to a network time server:

1. Check the *Enable auto adjustment* checkbox.
2. Drop down the time server list to select your preferred time server.

- or -

Check the *Preferred custom server IP* checkbox and key in the IPv4 address, IPv6 address or domain name of the time server of your choice.

3. If you want to configure an alternate time server, check the *Alternate time server* checkbox and repeat step 2 for the alternate time server entries.
4. Key in your choice for the number of days between synchronization procedures.
5. If you want to synchronize immediately, click **Adjust Time Now**.

7.10 Log

The B064C-16-1-IP logs all the events that take place on it. To view the contents of the log, click the *Log* tab.

Browser GUI

Time	Severity	User	Log Information
2023/09/04 13:39:16	Most	System	OP: User administrator from 10.3.32.109 (00-1A-C1-59-E1-C1) attempting to login via browser.
2023/09/04 13:38:25	Most	System	OP: User administrator from 10.3.32.109 (00-1A-C1-59-E1-C1) logged out via browser.
2023/09/04 13:38:23	Most	System	OP: User administrator from 10.3.32.109 (00-1A-C1-59-E1-C1) attempting to login via browser.
2023/09/01 14:26:15	Least	administrator	OP: User administrator changes to [01-01] 7170.
2023/09/01 14:23:21	Most	administrator	OP: Local user administrator logged in.
2023/09/01 14:22:50	Most	System	SYS: Accept new IP address 10.3.166.208 for network interface 1
2023/09/01 14:22:46	Most	System	SYS: Loading system setting

7. Administration

AP GUI

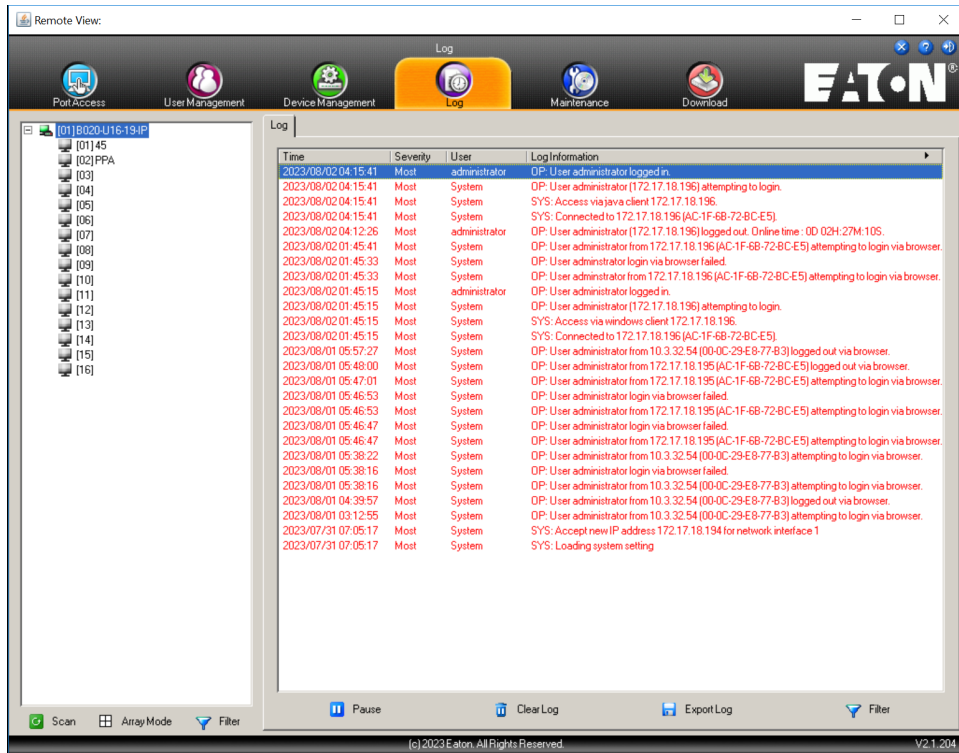

7.10.1 Log Information

The *Log* page displays events that take place on the B064C-16-1-IP, and provides a breakdown of the time, user and a description of each. You can change the sort order of the display by clicking on the column headings.

The log file tracks a maximum of 512 events. When the limit is reached, the oldest events get discarded as new events come in.

7. Administration

7.11 Maintenance

The *Maintenance* function is used to upgrade firmware, backup and restore configuration and account information, and restore default values.

Browser GUI

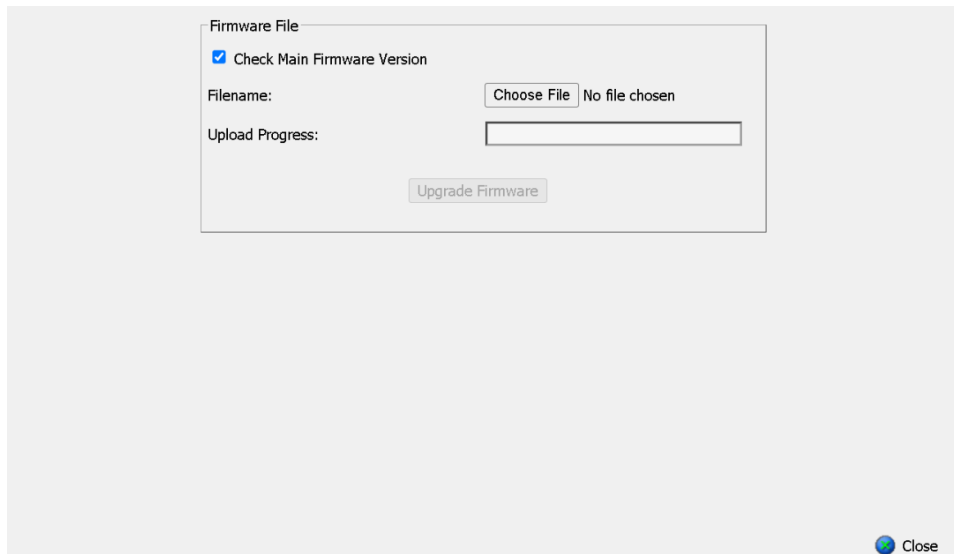

AP GUI

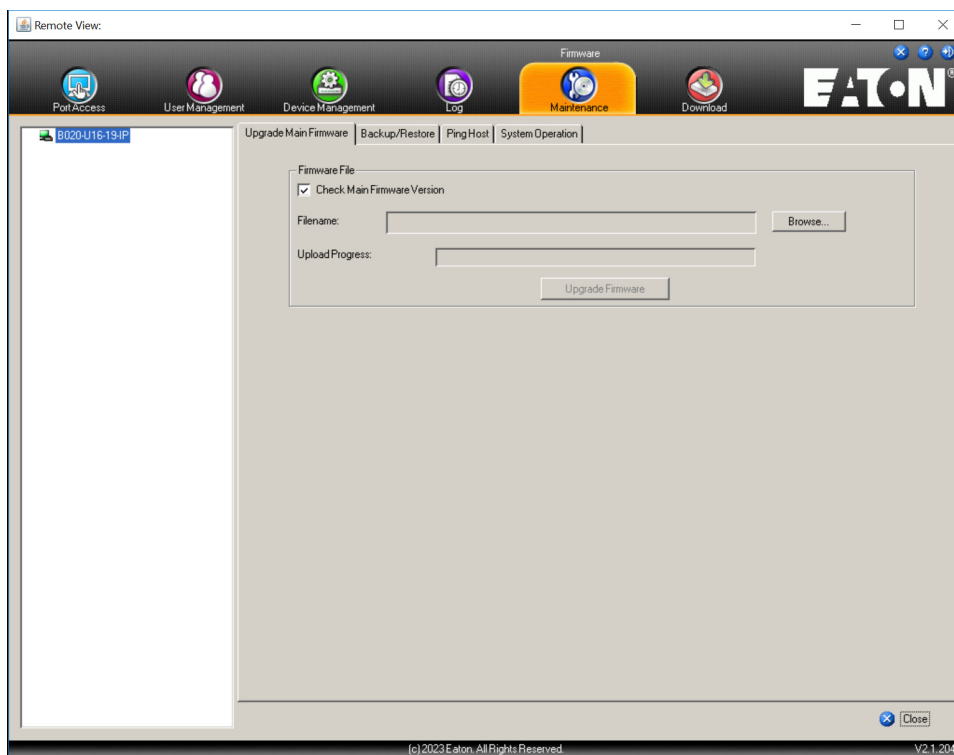

7. Administration

7.11.1 Device IP Card Firmware Upgrade

As new versions of the firmware become available, they can be downloaded from our website:

TrippLite.Eaton.com/products/management-firmware-matrix. Check the website regularly to find the latest information and packages.

To upgrade the device firmware:

1. Download the latest IP card firmware to your computer.
2. Log in to the B064C-16-1-IP and click the *Maintenance* tab. The Maintenance tab opens to the *Firmware File* page:

Firmware File

Check Main Firmware Version

Filename: No file selected.

Upload Progress:

3. Click **Browse**. Navigate to the directory that the new IP card firmware file is in and select the file.
4. Click **Upgrade Firmware** to start the upgrade procedure.
 - If you enabled *Check Main Firmware Version*, the current firmware version is compared with that of the upgrade file. If the current version is equal to or higher than the upgrade version, a popup message appears and stops the upgrade procedure.
 - If you did not enable *Check Main Firmware Version*, the upgrade file is installed without checking what version it is.
 - As the upgrade proceeds, progress information is shown in the *Progress* bar.
 - Once the upgrade completes successfully, the switch will reset.
5. Log in again and check the firmware version to be sure it is the new one.

Note: To recover from a "failed upgrade" situation, see **7.11.3 Recovering from Failed Firmware Upgrade**.

7.11.2 Mainboard and KVM Adapter Cable Firmware Upgrade

The *Upgrade Adapters* page is used to upgrade the firmware of the Stations / KVM adapter cables. *Station* in this section refers to the mainboard firmware of a KVM switch.

Options

Check Station/Adapter Firmware Version

Name	Station/Adapter	F/W Version	Status
B064C-16-1-IP	B064C-16-1-IP	V1.6.158	
[01]PC1	B055-001-USB	V3.4.332	

7. Administration

Mainboard Firmware Upgrade

1. Log in to the B064C-16-1-IP and click the *Maintenance* tab, then select the *Upgrade Adapter* menu item.
Note: *The mainboard firmware package contains software for device mainboards as well as KVM adapter cables.*
2. The *Adapter Firmware* info button will now display a list of the mainboard firmware and adapter version that are stored in current device IP card.
3. Compare the mainboard firmware version stored in the firmware package with the version listed in the *Current FIW Version* column of the Main Panel. If the version stored in the new firmware package is newer than the one on the mainboard, perform the upgrade.
4. In the *Name* column of the Main Panel, check the port whose device you want to upgrade. Here you can select whether to upgrade the firmware for just the mainboard (top checkbox), just the KVM adapter cables (bottom checkbox) or both.
5. Click **Upgrade** to start the upgrade procedure.

When the procedure completes, the new adapter firmware version is displayed.

KVM Adapter Cable Firmware Upgrade

1. Log in to the B064C-16-1-IP, click the *Maintenance* tab, then select the *Upgrade Adapter* menu item.
Note: *The mainboard firmware package contains software for device mainboards as well as KVM adapter cables.*
2. The *Adapter Firmware* info button will display a list of the mainboard firmware and adapter versions that are stored in the current device IP card.
3. Compare the adapter firmware version stored in the main firmware with the version listed in the *Current FIW Version* column of the Main Panel. If the version stored in the new firmware package are newer than the one on the adapter, perform the adapter upgrade.
4. In the *Name* column of the Main Panel, check the port whose device you want to upgrade. Here you can select whether to upgrade the firmware for just the mainboard (top checkbox), just the KVM adapter cables (bottom checkbox), or both.
5. Click **Upgrade** to start the upgrade procedure.

When the procedure completes, the new adapter firmware version is displayed.

Notes:

- *The switch may work with older adapter firmware versions, but for optimum compatibility we recommend upgrading your KVM adapter cable firmware to that stored in the switch's latest mainboard firmware package.*
- *You can perform the upgrade procedure any time you add an KVM adapter cable to the installation to make sure it is working with the latest firmware version.*
- *To recover from a "failed upgrade" situation, see **7.11.3 Recovering from Failed Firmware Upgrade**.*

7. Administration

Station/Adapter Firmware Info

The *Station / Adapter Firmware Info* button provides a list of the adapter cable firmware stored on the switch's main firmware. You can use this information to compare it to the *FW Version* listed for the connected adapter cables. For optimum compatibility, we recommend upgrading your adapter cable's firmware to match that stored with the switch's main firmware.

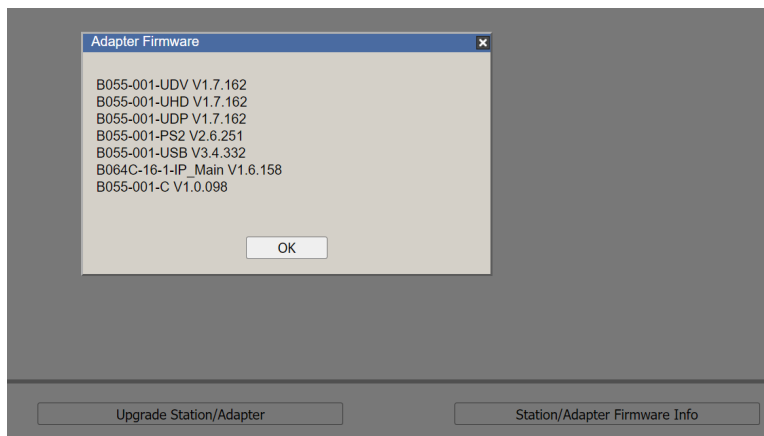

7.11.3 Recovering from Failed Firmware Upgrade

Station (Mainboard) and Adapter Firmware

Should the adapter firmware upgrade procedure fail for one of the KVM adapter cables and the adapter becomes unusable, follow the steps below to resolve the problem:

1. Unplug the adapter from the server it is connected to.
2. Slide its *firmware upgrade switch* (located next to the Cat5e connector) to the **RECOVER** position.
3. Plug the adapter back into the server.
4. Repeat the adapter upgrade procedure.
5. After the adapter has been successfully upgraded, unplug the adapter from the server it is connected to, slide the firmware upgrade switch back to the **NORMAL** position and plug the adapter back in.

7. Administration

7.11.4 Backup/Restore

Selecting the *Backup / Restore* menu item gives you the ability to back up the switch's configuration and user profile information:

The screenshot shows a web interface for Backup and Restore operations. It is divided into two main sections: Backup and Restore. The Backup section includes a Password field and a Backup button. The Restore section includes a Filename field with a Browse... button and the text 'No file selected.', a Password field, three radio buttons (Select All, User Account, User Select), and an Options box containing six checked checkboxes: Account, ANMS, Date/Time, Network, Security, and Operating Mode. A Restore button is located at the bottom of the Restore section.

Backup

To backup the device's settings:

1. In the *Password* field, key in a password for the file.

Notes:

- *Setting a password is optional. If you do not set a password, the file can be restored without specifying a password.*
- *If you do set a password, make a note of it to be able to restore the file.*

2. Click **Backup**.
3. When the browser asks what you want to do with the file, select *Save to disk*, then save it in a convenient location.

Restore

To restore a previous backup, do the following:

1. Click **Browse**, navigate to the file and select it.

Note: *If you renamed the file, you can leave the new name. Returning it to its original name is unnecessary.*

2. If you set a password when you created the file, key it in the *Password* field.
3. Select as many of the options that are presented as you wish to restore.
4. Click **Restore**.

Once the file is restored, a message will appear to inform you the procedure was successful.

7. Administration

7.11.5 Ping Host

The *Ping Host* page allows you to ping a device's IP address by entering the hostname or IP address and view or configure options. After entering commands, the window will display the results.

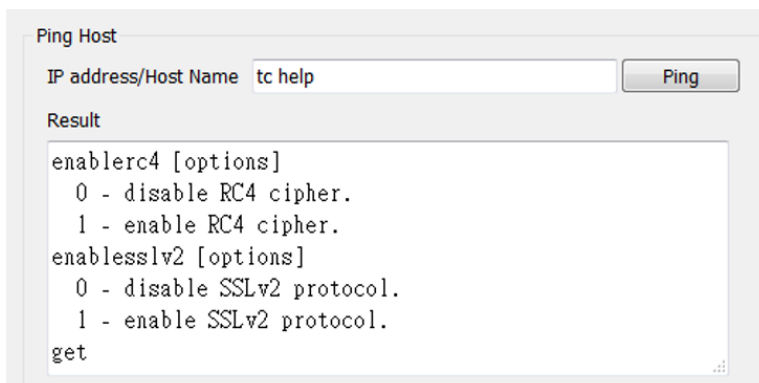

Use the table below to enter Commands in the box and click **Ping** to run the command.

Type	Function	Command
Help	Lists the available commands	tc help
Get Status	Lists the current configuration for all options	tc get
SSLv2	Show current SSLV2 configuration	tc enablessl2
	Disable SSLv2	tc enablessl2 0
	Enable SSLv2	tc enablessl2 1
TLSv1	Show current TLSv1.0 configuration	tc enabletlsv1.0
	Disable TLSv1.0	tc enabletlsv1.0 0
	Enable TLSv1.0	tc enabletlsv1.0 1
TLSv1.1	Show current TLSv1.1 configuration	tc enabletlsv1.1
	Disable TLSv1.1	tc enabletlsv1.1 0
	Enable TLSv1.1	tc enabletlsv1.1 1
RC4 Cipher	Show current RC4 cipher configuration	tc enablerc4
	Disable RC4 cipher	tc enablerc4 0
	Enable RC4 cipher	tc enablerc4 1
SSL Cipher	Show current SSL Cipher configuration	tc setsslcipher
	Use LOW, MEDIUM and HIGH ciphers	tc setsslcipher 0
	Use MEDIUM and HIGH ciphers	tc setsslcipher 1
	Use HIGH ciphers only	tc setsslcipher 2

7. Administration

7.11.6 System Operation

The *System Operation* page lets you restore certain configuration changes that were made to the B064C-16-1-IP to their original factory default values.

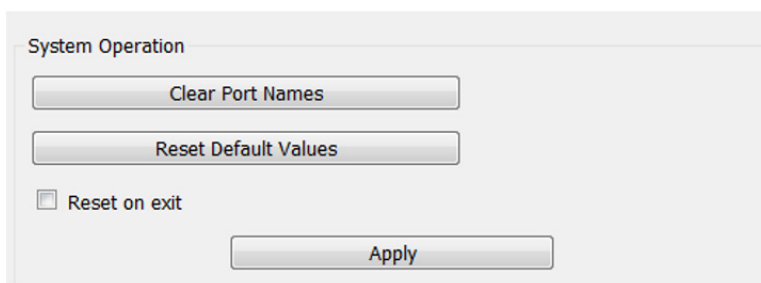

The functions performed on this page are as follows:

Clear Port Names

Clicking this button removes names that have been assigned to the ports.

Reset Default Values

Clicking this button undoes all Customization page changes that have been made to the B064C-16-1-IP (except for the Port Names), as well as the Network Transfer Rate (on the Network page) and returns the parameters to the original factory default settings.

Apply

Clicking this button resets the B064C-16-1-IP and implements all new settings when you log out. Following the reset, wait approximately 30 to 60 seconds before logging back in.

Note: Even though the changed IP settings are ignored, they still remain in the network settings fields. The next time you open this page, the *Reset on exit* checkbox will automatically be enabled and when the switch resets the new IP settings presumed discarded will become the ones used by the switch. To avoid this problem, go back to the network settings page and be sure that the IP settings appearing in the fields are those you want to use.

7.12 Download

Download is used to download stand-alone AP versions of the Windows Client, Java Client and Log Server.

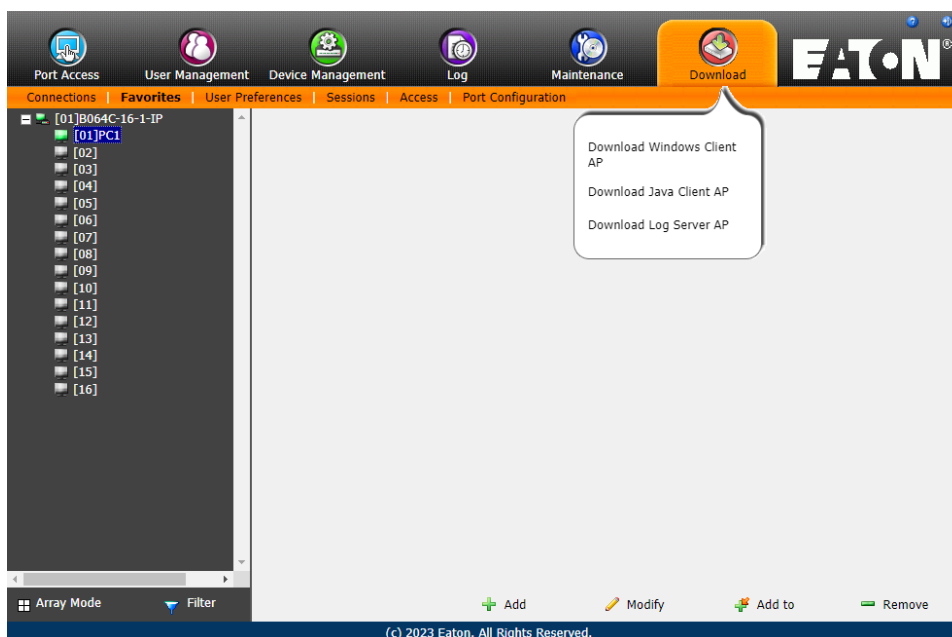

7. Administration

Click the *Download* tab to select the program you want to download, save it to a convenient location on your hard disk and run it.

7.13 Port Operation

Once you have successfully logged in (see **7.5 Logging In**), the B064C-16-1-IP opens to the *Port Access tab's Connections* page, with the first B064C-16-1-IP selected in the sidebar:

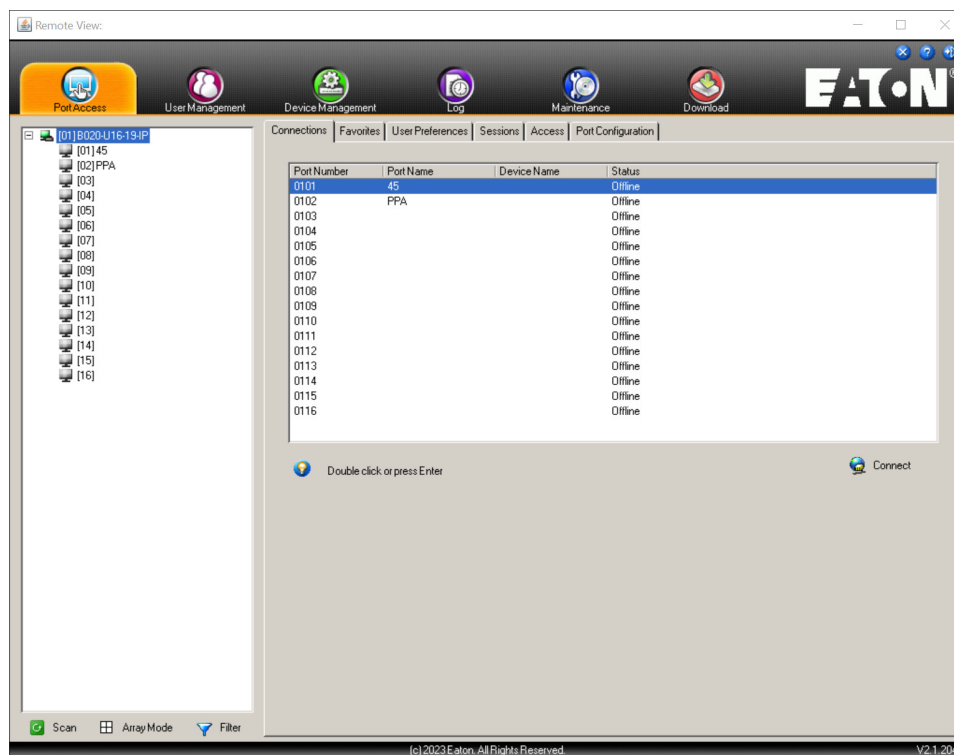

7.13.1 Connecting to a Port

All the devices, ports and outlets that a user is permitted to access are listed in the Sidebar on the left of the page.

- To connect to a port when a device is selected in the Sidebar, double click its icon in the Sidebar, double click anywhere on its line entry in the main central panel or select it in the main panel and click **Connect** at the bottom right of the page.
- To connect to a port when the port is selected in the Sidebar, click **Connect** at the right of the *Status* panel.

Once you switch to a port, its screen will display on your monitor and your keyboard and mouse input will work with the remote server:

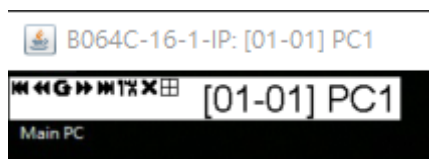

7. Administration

7.13.2 Port Toolbar

The B064C-16-1-IP interface provides a toolbar to assist with port switching operations from within the captured port. To access the toolbar, tap the OSD Hotkey (Scroll Lock or Ctrl), twice. The toolbar appears at the upper left corner of the screen:

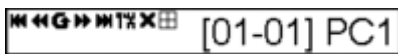

Depending on the settings that were selected for ID Display, the Port Number and/or the Port Name display at the right of the toolbar.

When the toolbar displays, mouse input is confined to the toolbar area and keyboard input has no effect on the server connected to the port. To carry out operations on the server, close the toolbar by clicking its **X** icon.









To return to the Port Access Connections page, click the appropriate icon or tap the OSD hotkey again.

Notes:

- You can adjust the toolbar transparency.
- The toolbar functions and icons are also incorporated in the Control Panel. If you choose to enable them in the Control Panel, you can disable the Toolbar (see **7.7.5 User Preferences**). To recall the Port Access Connections page when there is no Toolbar, simply tap the OSD hotkey twice.

Toolbar Icons

The meanings of the toolbar icons are explained in the table below:

Icon	Purpose
	Click to skip to the first accessible port on the entire installation without having to recall the Port Access page.
	Click to skip to the first accessible port previous to the current one without having to recall the Port Access page.
	Click to begin Auto Scan Mode. The B064C-16-1-IP automatically switches among the ports that were selected for Auto Scanning. This allows you to monitor their activity without having to switch among them manually.
	Click to skip from the current port to the next accessible one without having to recall the Port Access page.
	Click to skip from the current port to the last accessible port on the entire installation without having to recall the Port Access page.
	Click to recall the Port Access page.
	Click to invoke Panel Array Mode (see 7.13.3 Panel Array Mode).
	Click to close the toolbar.

7. Administration

Toolbar Hotkey Port Switching

When the toolbar displays, you can use hotkeys to provide KVM focus to a port directly from the keyboard. The B064C-16-1-IP provides the following hotkey features:

- Going directly to a port by keying in its port number and clicking Enter.
- Auto Scanning
- Skip Mode Switching

The hotkeys are: **A** and **P** for Auto Scanning and the **Arrow Keys** for Skip Mode.

Notes:

- For hotkey operations to take place, the toolbar must be visible (see **7.13.2 Port Toolbar**).
- To use the keys designated as hotkeys (i.e. A, P, etc.) for normal, non-hotkey purposes, you must first close the toolbar.
- For issues affecting multiple user operation in Auto Scan Mode, see **7.13.4 Multiuser Operation**.

Auto Scanning

The Scan function automatically switches among all the ports that are accessible to the currently logged on user at regular intervals so the user can monitor their activity automatically.

- Setting the Scan Interval

The amount of time Auto Scan dwells on each port is set with the *Scan Duration* setting.

- Invoking Auto Scan

To start Auto Scanning with the toolbar showing tap the **A** key. The Auto Scan function cycles through the ports in order starting from the first port on the installation. An **S** appears in front of the Port ID Display to indicate the port is being accessed in Auto Scan Mode.

- Pausing Auto Scan

While you are in Auto Scan Mode, you can pause scanning to better maintain focus on a particular server by pressing **P**. During the time that Auto Scanning is paused, the **S** in front of the Port ID will blink.

Pausing when you want to maintain focus on a particular server can be more convenient than exiting Auto Scan Mode because when you *Resume* scanning, you start from where you left off. If on the other hand, you were to exit and then restart Auto Scan Mode, the scanning would start over from the very first server on the installation.

To *Resume* Auto Scanning after a pause, press any key except [Esc] or the [Spacebar]. Scanning continues from where it left off.

- Exiting Auto Scan

While Auto Scan Mode is in effect, ordinary keyboard functions are suspended. You must exit Auto Scan Mode to regain normal control of the keyboard. To exit Auto Scan Mode, press **[Esc]** or **[Spacebar]**. Auto Scanning stops when you exit Auto Scan Mode.

Skip Mode

Skip Mode allows you to switch ports to monitor the servers manually. You can focus on a particular port for as long or as little as you like (as opposed to Auto Scanning, which automatically switches after a fixed interval). The Skip Mode hotkeys are the four Arrow keys.

Arrow	Action
←	Skips from the current port to the first accessible port previous to it.
→	Skips from the current port to the first accessible port that comes after it.
↑	Skips from the current port to the first accessible port on the installation.
↓	Skips from the current port to the last accessible port on the installation.

7. Administration

Recalling the Port Access Page

To dismiss the toolbar and return to the Port Access page, do one of the following:

- Tap the OSD Hotkey once.
- From the toolbar, click the icon that recalls the Port Access page.

The toolbar will close and the Port Access Page will appear.

OSD Hotkey Summary Table

The following table presents a summary of the OSDHotkey actions after you have accessed a port. See **7.7.5 User Preferences** to set the OSD Hotkey.

To...	Do This...	
Open the Toolbar	Click the OSD Hotkey twice	
Open the Port Access Page	The Toolbar is open	Click the OSD Hotkey once
	The Toolbar is not open	Click the OSD Hotkey three times

7.13.3 Panel Array Mode

Clicking the toolbar's *Panel* icon invokes Panel Array Mode. Under this mode, the screen divides into a grid of up to 42 panels:

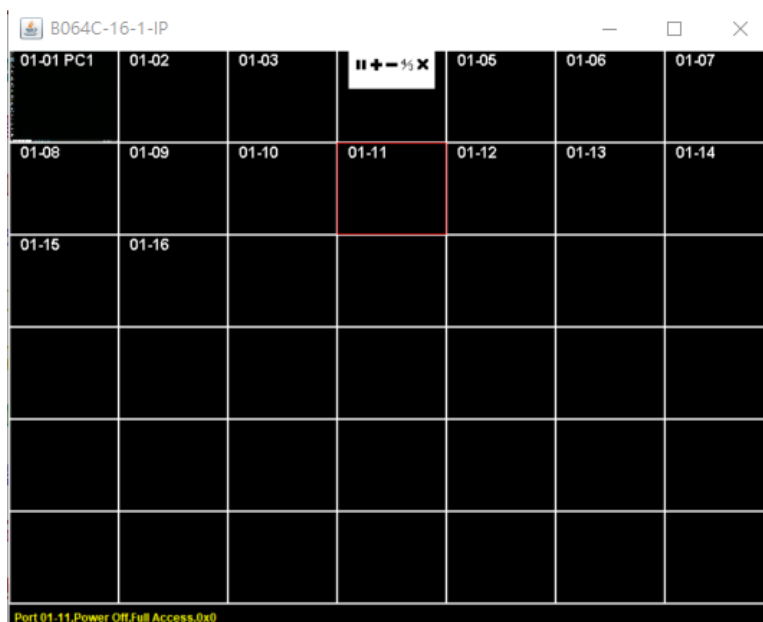







- Each panel represents one of the switch's ports beginning with Port 1 at the upper left, and going from left to right, top to bottom.
- The number of panels in the array can be selected by clicking the *Show More Ports* and *Show Fewer Ports* symbols on the panel array toolbar.
- Only ports that are accessible to the user are displayed. For ports that are not accessible, the panel will be blank.
- If the server connected to a port is online, its screen displays in its panel; otherwise the panel will be blank.
- Hovering a mouse over a panel displays information about the port (port name, online status, port access status and resolution).
- You can access a server connected to a port by moving the mouse pointer over its panel and clicking. You can switch to the server exactly as if you had selected it from the Port Access page.

7. Administration

Panel Array Toolbar

The panel array toolbar provides shortcut navigation and control of the panel array. The toolbar can be dragged anywhere on the screen. Mousing over an icon opens a “tooltip” that provides a short description of the icon’s function.

Icon	Purpose
	Click and drag to move the toolbar. Note: This icon is only available with the Windows Clients. To move the Java Client toolbars, click on any empty space and drag.
	Pause panel scanning, leaving the focus on the panel that currently has it.
	Show More Ports: Increase the number of panels in the array.
	Show Fewer Ports: Decrease the number of panels in the array.
	Toggle 4/3 aspect ratio.
	Exit Panel Array mode.

7.13.4 Multiuser Operation

The B064C-16-1-IP supports multiuser operation. When multiple users simultaneously access the switch from client computers, the rules of precedence that apply are shown in the following table:

Operation	Rule
General	The switches utilize a single shared bus implementation. Although they support local and remote login at the same time, they do not support independent operation. If a local user logs in while a remote user has already opened a session, the local user sees the same screen that the remote user is working on
Auto Scan Mode	If a user has invoked Auto Scan Mode and another user logs on, at first the new user will see the GUI Main Page. However, as soon as they access any port, they will automatically enter Auto Scan Mode. Any user can halt Auto Scan Mode by recalling the GUI Main Page. When this occurs, Auto Scan Mode stops and all the other users on the bus are switched to the port that was being accessed when Auto Scan Mode stopped.
Panel Array Mode	<ul style="list-style-type: none">• If a user has invoked Panel Array Mode and another user logs on, the new user will enter the GUI Main Page. However as soon as they access any port, they will automatically enter Panel Array Mode.• Panel Array Mode continues until the original user stops it (Administrators can override Panel Array Mode, however).• Only the user who starts Panel Array Mode can use the Skip Mode function.• Only the user who starts Panel Array Mode can switch ports. Other users automatically switch to the ports that the original user selects. However, if one of the other users does not have access rights to the port that the original user switches to, that user will not be able to view the port.• Individual users can increase or decrease the number of panels they wish to view in Panel Array Mode. However, the picture quality may decrease as the number of panels increases.

7. Administration

7.14 Log Server

The Windows-based Log Server is an administrative utility that records all events that take place on selected B064C-16-1-IP units and writes them to a searchable database.

7.14.1 Log Server Installation

1. Log into the B064C-16-1-IP.
2. Click the *Download* tab and download the *Log Server AP* program.
3. Go to the location on your hard disk that you downloaded the Log Server program to and double click its icon (*LogSetup.exe*) to access the Windows Client Connection Screen.

Note: *If the browser cannot run the file, save it to disk and run the file from your disk.*

The Log Server installation screen will appear:

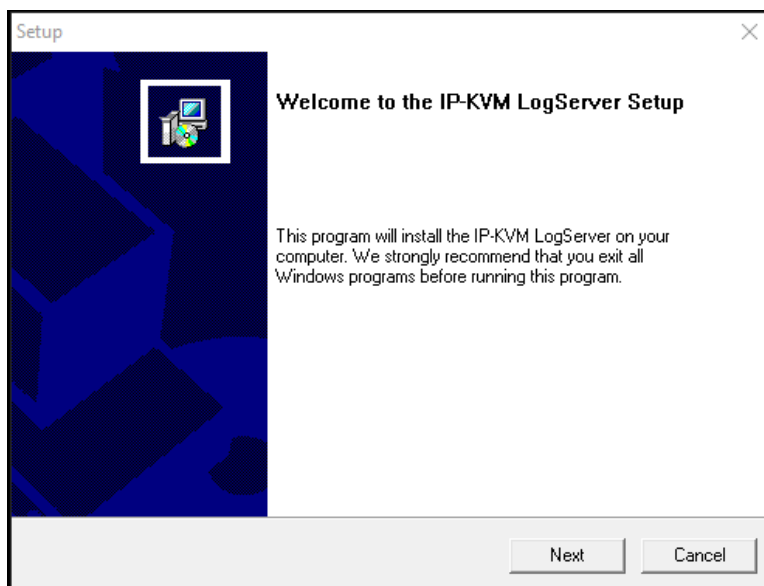

4. Click **Next**, then follow the on-screen instructions to complete the installation and have the Log Server program icon placed on your desktop.

7. Administration

7.14.2 Log Server Start Up

To start the *Log Server*, double click the program icon or key in the full path to the program on the command line. The first time you run it, a screen similar to the one below will appear:

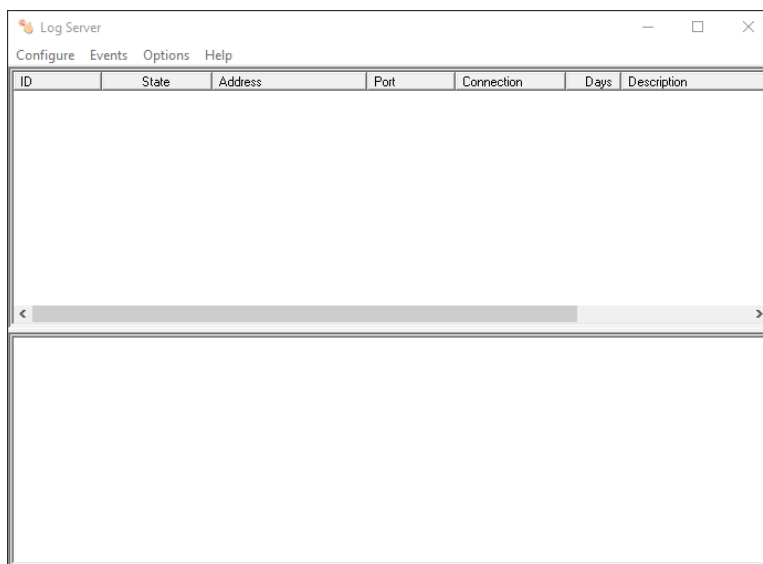

Notes:

- The MAC address of the Log Server computer must be specified in the *ANMS settings*.
- The Log Server requires the Microsoft Jet OLEDB 4.0 driver.

The Menu Bar

The *Menu Bar* consists of four items:

- Configure
- Events
- Options
- Help

Note: If the *Menu Bar* appears to be disabled, click in the *List* window to enable it.

Configure

The *Configure* menu contains three items: *Add*, *Edit* and *Delete*. They are used to add new units to the *List*, edit the information for units already on the list or delete units from the list.

- To add a unit to the list, click **Add**.
 - To edit or delete a listed unit, first select the target in the *List* window, then open this menu and click **Edit** or *Delete*.
- When you choose *Add* or *Edit*, a dialog box similar to the one below will appear:

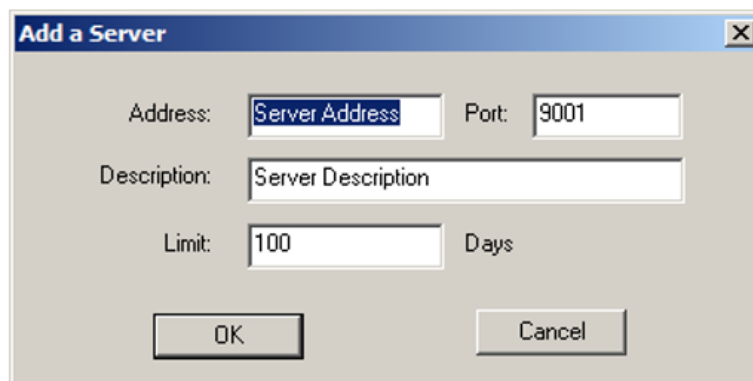

7. Administration

A description of the fields is provided in the table below:

Field	Explanation
Address	This can either be the IP address of the computer the Log Server is running on, or its DNS name.
Port	The port number that was assigned to the Log Server under <i>Device Management</i> (see 7.14 Log Server).
Description	This field is provided so that you can put in a descriptive reference for the unit to help identify it.
Limit	This specifies the number of days an event should be kept in the Log Server's database. Events that exceed the amount of time specified here can be removed with the Maintenance function (see 7.11 Maintenance).

Fill in or modify the fields, then click **OK** to finish.

Events

The *Events Menu* has two items: *Search* and *Maintenance*.

Search

Search allows you to search for events containing specific words or strings. When you access this function, a screen similar to the one below will appear:

The screenshot shows a 'Search Dialog' window with the following components:

- Search Options:** Three radio buttons: 'New search' (selected), 'Search last results', and 'Search excluding last results'.
- Server List:** A text box containing '172.17.18.194'.
- Priority List:** A text box containing 'Least', 'Less', and 'Most'.
- Filters:** Fields for 'Start date' (8/ 1/2023), 'Start time' (5:24:10 AM), 'End date' (8/ 2/2023), 'End time' (5:24:10 AM), and 'Pattern'.
- Result:** A list of search results for server 172.17.18.194:
 - 2023/08/02 05:17:28 : DM: User administrator clear log.
 - 2023/08/02 05:18:25 : DM: User administrator modified ANMS setting.
 - 2023/08/02 05:19:13 : DP: User administrator from 172.17.18.196 (AC-1F-6B-72-BC-E5) logged out via browser.
 - 2023/08/02 05:19:27 : DP: User administrator from 172.17.18.196 (AC-1F-6B-72-BC-E5) attempting to login via browser.
 - 2023/08/02 05:22:59 : DM: User administrator modified ANMS setting.
 - 2023/08/02 05:23:08 : Log Server start - 172.17.18.196
- Buttons:** Search, Print, Export, and Exit.

7. Administration

A description of the items is provided in the table below:

Item	Description
New Search	This is one of three radio buttons that define the scope of the search. If it is selected, the search is performed on all the events in the database for the selected unit.
Search Last Results	This is a secondary search performed on the events that resulted from the previous search.
Search Excluding Last Results	This is a secondary search performed on all the events in the database for the selected unit excluding the events that resulted from the previous search.
Server List	B064C-16-1-IP units are listed according to their IP address. Select the unit that you want to perform the search on from this list. You can select more than one unit for the search. If no units are selected, the search is performed on all.
Priority	Sets the level for how detailed the search results display should be. Least is the most general and Most is the most specific. Least results appear in black and Less results appear in blue; most results appear in red.
Start Date	Select the date that you want the search to start from. The format follows the YYYY/MM/DD convention, as follows: 2024/11/04
Start Time	Select the time that you want the search to start from. The format follows the HH:MM:SS convention.
End Date	Select the date that you want the search to end at.
End Time	Select the time that you want the search to end at.
Pattern	Key in the pattern that you are searching for here. The multiple character wildcard (%) is supported. (e.g., h%ds would match hands and hoods).
Results	Lists the events that contained matches for the search.
Search	Click this button to start the search.
Print	Click this button to print the search results.
Export	Click this button to save the search results to file.
Exit	Click this button to exit the Log Server.

Maintenance

This function allows the administrator to perform manual maintenance of the database, such as erasing specified records before their expiration time is up.

7. Administration

Options

Network Retry allows you to set the number of seconds that the Log Server should wait before attempting to connect if its previous attempt to connect failed. When you click this item, a dialog box similar to the one below will appear:

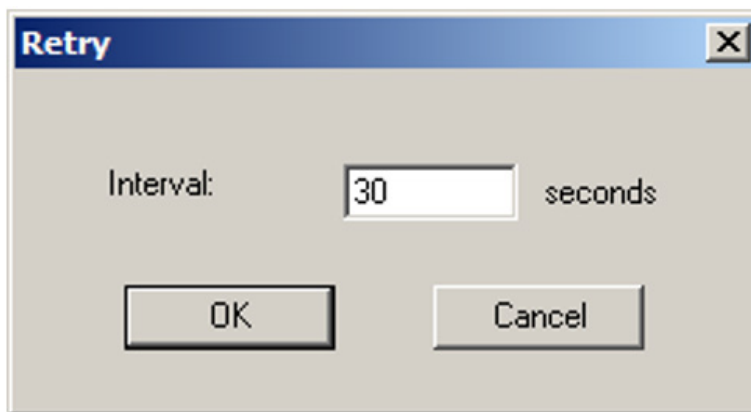

Key in the number of seconds, then click **OK** to finish.

Help

From the *Help* menu, click Contents to access the online Windows Help file. The help file contains instructions on how to set up, operate and troubleshoot the Log Server.

7.14.3 The Log Server Main Screen

The *Log Server Main Screen* is divided into two main panels.

- The upper (List) panel lists all units that have been selected for the Log Server to track.
- The lower (Event) panel displays the tick information for the currently selected unit (if there are more than one unit, the selected unit is the one that is highlighted).
- To select a unit in the list, simply click on it.

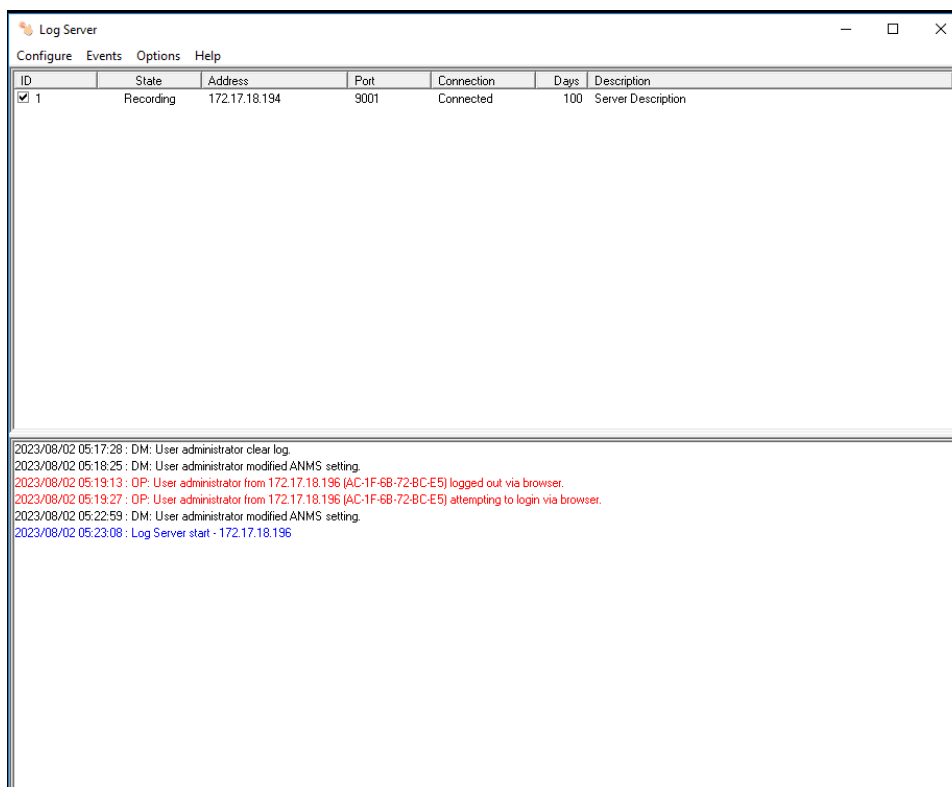

7. Administration

The List Panel

The *List* panel contains six fields:

Field	Explanation
Recording	Determines whether or not the Log Server records the ticks for this unit. If the Recording checkbox is checked, the field displays Recording and the ticks are recorded. If the Recording checkbox is not checked, the field displays Paused and the ticks are not recorded. Note: <i>Even though a unit is not the currently selected one, if its Recording checkbox is checked, the Log Server will still record its ticks.</i>
Address	This is the IP Address or DNS name that was given to the unit when it was added to the Log Server.
Port	This is the Access Port number assigned to the unit.
Connection	<ul style="list-style-type: none">• If the Log Server is connected to the unit, this field will display as <i>Connected</i>.• If the Log Server is not connected, this field will display as <i>Waiting</i>. This means that the Log Server's MAC address has not been set properly and needs to be set on the <i>Date/Time</i>.
Days	This field displays the number of days that the unit's log events are to be kept in the Log Server's database before expiration.
Description	This field displays the descriptive information given for the unit when it was added to the Log Server.

The Event Panel

The lower panel displays log events for the currently selected unit. Note that if there is more than one unit, even though they are not currently selected if their *Recording* checkbox is checked, the Log Server will record their log events and keep them in its database.

8. Troubleshooting

8.1 Administration

Problem	Resolution
After upgrading firmware, the B064C-16-1-IP still appears to be using the old firmware version.	Your Internet browser is displaying cached web pages, not new ones. Clear your browser cache, delete all temporary Internet files and cookies, close the Internet browser, and then open a new instance of the browser.
The default network setting for the B064C-16-1-IP is DHCP, but the network uses fixed IP addresses and does not have a DHCP server.	Use the local console OSD's F4 function to give the B064C-16-1-IP a fixed IP address.

8.2 General Operation

Problem	Resolution
Erratic Operation	Press and hold the Reset Switch for longer than three seconds.
Mouse and/or keyboard not responding due to improper mouse and/or keyboard reset.	Unplug the cable(s) from the console port(s), then plug it back in again.
Sudden loss of network connection due to local reset of B064C-16-1-IP.	Close your B064C-16-1-IP connection. Wait approximately 30 seconds and log in again.
Mouse Pointer Confusion	If you find the display of two mouse pointers (local and remote) to be confusing or annoying, you can use the <i>Toggle Mouse Display</i> function to shrink the non-functioning pointer.
Some characters that are keyed in do not display on the remote system	This is likely due to the local OS keyboard language and the remote OS keyboard language being different. Make sure that the keyboard language for both systems are the same.
Keyboard and/or mouse do not work after computer boots up.	For computers with PS/2 connectors, if you are using 2L-520xP cables, make sure all connectors (keyboard, video, and mouse) are plugged into their ports on the computer before starting the computer. Plugging the cables in after the computer has booted will not resolve the problem.
When I emulate the Sun keyboard, I cannot go into OK Mode ([Stop] [A]).	To go into OK Mode, use the following key sequence: 1. Press and release [Ctrl]. 2. Press and hold [T]. 3. Press and hold [A]. 4. Release [T] and [A] together.
There are ghost images on the external monitor.	The distance between the external console and the B064C-16-1-IP is too great. The maximum VGA cable distance should not exceed 65 ft. (20 m) and in some cases, may need to be shorter. Replace the VGA cable with one of an appropriately short length.
I cannot set the computers' screen resolutions higher than 1280 x 1024, even though the B064C-16-1-IP supports 1920 x 1200 for remote computers.	The maximum screen resolution of the B064C-16-1-IP's integrated LCD monitor is 1280 x 1024. To protect it from being damaged by resolutions that are beyond its display capability, we recommend the screen resolutions of the connected computers be set to 1280 x 1024 or lower. If you wish to set the screen resolutions of the connected computers to something higher than 1280 x 1024, see 8.8 Screen Resolutions Higher than 1280 x 1024 .

8. Troubleshooting

Problem	Resolution
When I switch to one of the computers on my installation, the LCD monitor screen goes blank. All I see is a black screen.	<p>The maximum screen resolution of the B064C-16-1-IP's integrated LCD monitor is 1280 x 1024. The screen resolution of the problem computer is set to something that is too high for the B064C-16-1-IP's LCD monitor to display.</p> <p>To resolve the problem, connect an external KVM console (with a monitor capable of displaying the problem computer's screen resolution) to the B064C-16-1-IP's external console ports. Use the external console to access the problem computer and reduce its resolution to 1280 x 1024.</p> <p>Note: Although the LCD monitor only supports video resolutions of up to 1280 x 1024, the B064C-16-1-IP, itself can support video resolutions up to 1920 x 1200 @ 60 Hz. If you wish to set the screen resolutions of the connected computers to something higher than 1280 x 1024, see 8.8 Screen Resolutions Higher than 1280 x 1024 for details.</p>
My B064C-16-1-IP unit is not listed in the Device List of the IP Installer.	<ul style="list-style-type: none"> • Make sure the Broadcast function is enabled from your switch or router for the auto-discover to work properly. • Make sure to turn off your firewall and/or antivirus software temporarily for the auto-discover to work properly. • Make sure the unit and the PC are under the same network segment.

8.3 Windows Client

Problem	Resolution
A "Login Failed" error appears and Windows Client Viewer cannot be run.	<ol style="list-style-type: none"> 1. Make sure your KVM over IP Switch is updated to the latest firmware version. 2. Make sure the required service ports, such as 80, 443, and 9000, are allowed by your firewall. 3. Close the viewer and try again.
Will not connect to the B064C-16-1-IP.	DirectX 8.0 or higher must be installed on your computer.
Remote mouse pointer is out of sync.	<ol style="list-style-type: none"> 1. Use the <i>AutoSync</i> feature to sync the local and remote monitors. 2. If that does not resolve the problem, use the <i>Adjust Mouse</i> feature to bring them back in sync. 3. If the two methods described above fail to resolve the problem, use the <i>Toggle Mouse Display</i> function.
Part of remote window is off my monitor.	Use the <i>AutoSync</i> feature to synchronize the local and remote monitors.
My antivirus program reports that there is a trojan after I access the B064C-16-1-IP with my browser and then open the Windows Client Viewer.	The Windows Client Viewer uses an ActiveX plug-in (windows.ocx) that some antivirus programs mistakenly see as a virus or trojan. We have tested our firmware extensively and found no evidence of a virus or trojan. You can add the plug-in to your antivirus program's White List and use the Viewer safely. If you are reluctant to use the Windows Client Viewer, however, you can simply use the Java Client Viewer, instead.

8. Troubleshooting

8.4 Java Client

Problem	Resolution
Java Client will not connect to the B064C-16-1-IP.	<ol style="list-style-type: none">1. Java JRE 6 update 3 or higher must be installed on your computer.2. Make sure to include the correct name of the web page when you specify the B064C-16-1-IP's IP address.3. Close the Java Client, reopen it and try again.
A "Login Failed" error appears and Java Client Viewer cannot be run.	<ol style="list-style-type: none">1. Make sure your KVM over IP Switch is updated to the latest firmware version.2. Make sure the required service ports, such as 80, 443, and 9000, are allowed by your firewall.3. Close the viewer and try again.
Pressing the Windows Menu key has no effect.	Java does not support the Windows Menu key.
Java Client performance deteriorates.	Exit the program and start again.
National language characters do not appear.	When entering national language characters, if your local keyboard is set to a non-English national language layout, you must set the remote computer's keyboard layout to English.

8.5 Log Server

Problem	Resolution
The Log Server program does not run.	<p>The Log Server requires the Microsoft Jet OLEDB 4.0 driver to access the database.</p> <p>This driver is automatically installed with Windows ME, 2000, and XP.</p> <p>For Windows 98 and NT you will have to go to the Microsoft download site: http://www.microsoft.com/data/download.htm to retrieve the driver file:</p> <p>MDAC 2.7 RTM Refresh (2.70.9001.0)</p> <p>Since this driver is used in Windows Office Suite, an alternate method of obtaining it is to install Windows Office Suite. Once the driver file or Suite has been installed, the Log Server will run.</p>

8.6 Panel Array Mode

Problem	Resolution
Low resolution video in Panel Array Mode.	Increase the number of panels that are displayed.
Some users only receive a partial image when multiple remote users are logged in concurrently.	The first user to invoke Panel Array Mode should set it to display a minimum of four panels.

8. Troubleshooting

8.7 Sun Systems

Problem	Resolution
Video display problems with HDB-15 interface systems (e.g., Sun Blade 1000 servers).	The display resolution should be set to 1024 x 768. Under Text Mode: 1. Go to OK mode and issue the following commands: <code>setenv output-device screen:r1024x768x60</code> <code>reset-all</code> Under XWindow: 1. Open a console and issue the following command: <code>m64config -res 1024x768x60</code> 2. Log out. 3. Log in.
Video display problems with 13W3 interface systems (e.g. Sun Ultra servers)*	The display resolution should be set to 1024 x 768. Under Text Mode: 1. Go to OK mode and issue the following commands: <code>setenv output-device screen:r1024x768x60</code> <code>reset-all</code> Under XWindow: 1. Open a console and issue the following command: <code>ffbconfig -res 1024x768x60</code> 2. Log out. 3. Log in.

*These solutions work for most common Sun VGA cards. If using them fails to resolve the problem, consult the Sun VGA card's manual.

8.8 Screen Resolutions Higher than 1280 x 1024

The maximum screen resolution of the B064C-16-1-IP's integrated LCD monitor is 1280 x 1024. To protect it from being damaged by resolutions that are beyond its display capability, we recommend the screen resolutions of the connected computers be set to 1280 x 1024 or lower.

If you wish to display screen resolutions higher than 1280 x 1024, follow the procedure described below.

Notes:

- We strongly recommend you close the B064C-16-1-IP LCD console before continuing (see **6.1.2 Closing the Console**). Using the LCD monitor to view computers that are set to resolutions that exceed its maximum capability can damage it and shorten its life span.
- To access computers from the external local console when the integrated console is closed, simply connect an external KVM console with a monitor that supports 1920 x 1200 @ 60 Hz to the B064C-16-1-IP's external console ports.

1. From a remote computer, log in to the B064C-16-1-IP and access the computer whose screen resolution you wish to change.
2. Open the computer's *Control Panel* and double-click **Display**. The *Display Properties* dialog box will appear.
3. Click the **Settings** tab, then click **Advanced**.
4. In the dialog box that appears, click the **Monitor** tab.
5. Under *Monitor settings*, click to clear the *Hide modes that this monitor cannot display* check box.
6. Click **Apply**.
7. Click the **Adapter** tab, then click **List All Modes**. The *List All Modes* dialog box appears.
8. Under *List of valid modes*, select the display mode that you want the computer to use.

Note: The maximum screen resolution and refresh rate that the supported for the external local console and remote computers is 1920 x 1200 @60 Hz.

8. Troubleshooting

9. Click **OK**, and then click **Apply**. The display mode will change to the one you selected.
 10. If the *Monitor Settings* dialog box appears requesting you to confirm the settings change, click **Yes**.
 11. After the *Monitor Settings* dialog box closes, click **OK**.
 12. In the *Display Properties* dialog box, click **OK**.
- Repeat these steps for any other computer whose screen resolution you wish to change.

8.9 Additional Mouse Synchronization Procedures

If the mouse synchronization procedures mentioned in the manual fail to resolve mouse pointer problems for particular computers, try the following:

Notes:

- *These procedures are to be performed on the computers attached to the B064C-16-1-IP's ports, not on the computer you are using to access the B064C-16-1-IP.*
- *For the local and remote mice to synchronize, you must use the generic mouse driver supplied with the Windows operating system. If you have a third party driver installed (such as one supplied by the mouse manufacturer), you must remove it.*

8.9.1 Windows

1. Windows 2000:
 - a) Open the *Mouse Properties* dialog box (Control Panel → Mouse → Mouse Properties)
 - b) Click the **Motion** tab.
 - c) Set the mouse speed to the middle position (6 units in from the left).
 - d) Set the mouse acceleration to *None*.

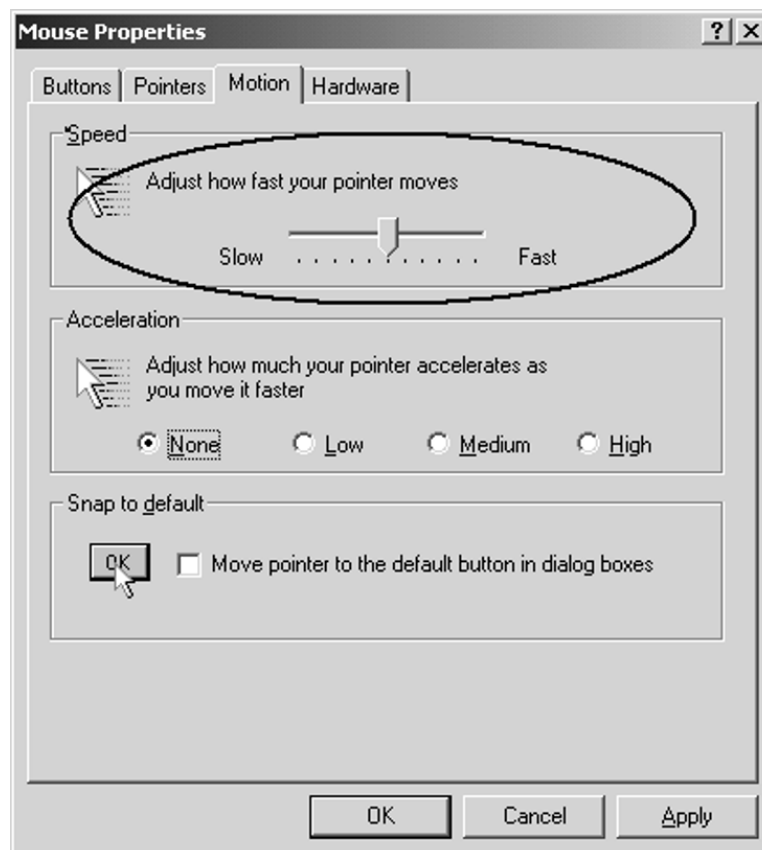

8. Troubleshooting

2. Windows XP / Windows Server 2003:

- a) Open the Mouse Properties dialog box (Control Panel → Mouse)
- b) Click the **Pointer Options** tab.
- c) Set the mouse speed to the middle position (6 units in from the left).
- d) Disable *Enhance Pointer Precision*.

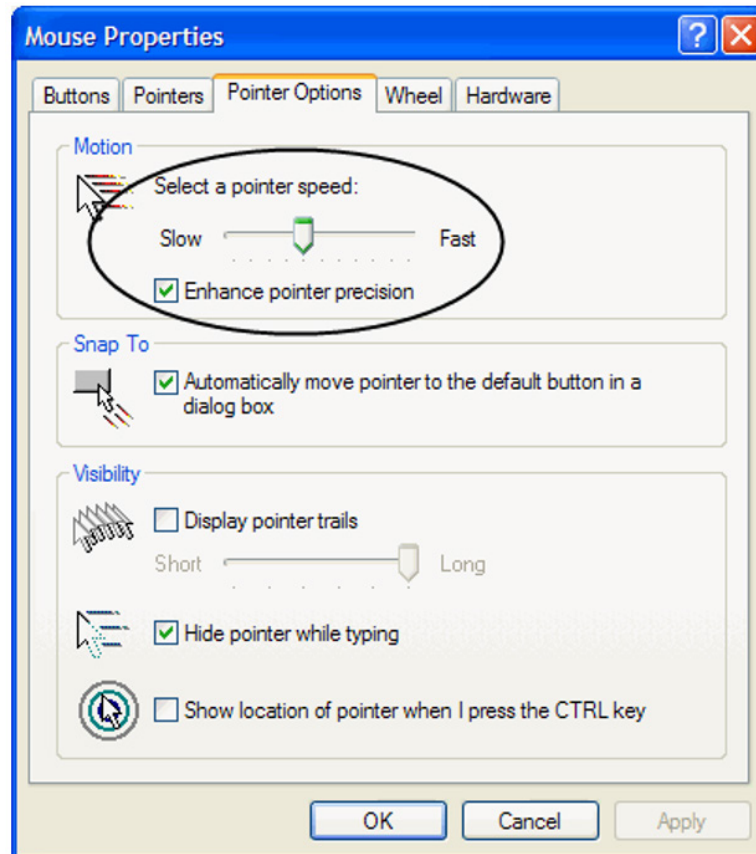

3. Windows ME:

Set the mouse speed to the middle position and disable mouse acceleration (click **Advanced** to get the dialog box).

4. Windows NT / Windows 98 / Windows 95: Set the mouse speed to the slowest position.

8.9.2 Sun / Linux

Open a terminal session and issue the following command:

Sun: `xset m 1`

Linux: `xset m 0`

8. Troubleshooting

8.10 Clear Login Information

If you are unable to log in as an Administrator (for example, corrupted or forgotten Username and Password), you can clear the login information with the following procedure.

Note: Performing this procedure also returns all settings to their defaults.

1. Power off the B064C-16-1-IP and remove its housing.
2. Short the jumper labeled J15.

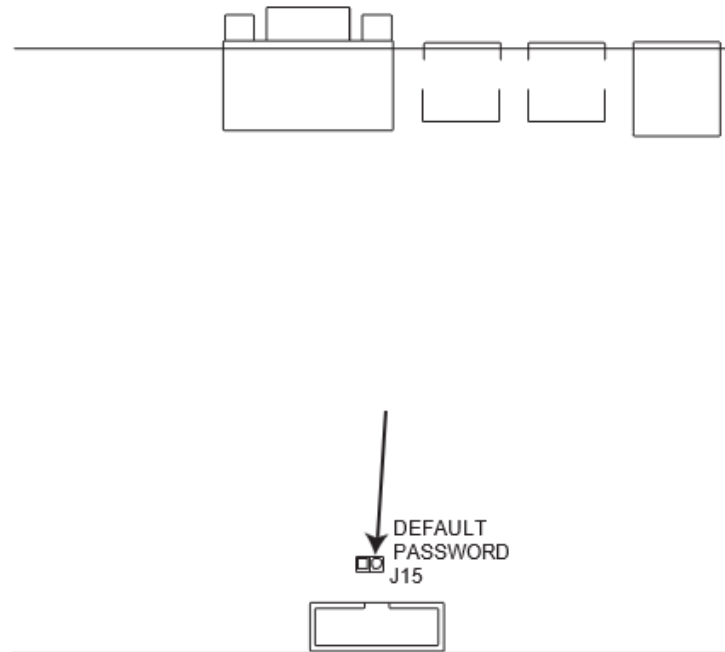

3. Power on the switch.
The onscreen display will show a message informing you that the password information has been cleared.
 4. Power off the switch.
 5. Remove the jumper cap from J15.
 6. Close the housing and restart the B064C-16-1-IP.
- After restarting the unit, you can use the default Username and Password to log in (see **7.2.1 OSD Overview**).

8. Troubleshooting

8.11 OSD Factory Default Settings

Setting	Default
OSD Hotkey	[Scroll Lock] [Scroll Lock]
Port ID Display Position	Upper Left Corner
Port ID Display Duration	3 Seconds
Port ID Display Mode	The Port Number plus the Port Name
Scan Duration	5 Seconds
Scan/Skip Mode	All
Screen Blanker	OFF
Hotkey Command Mode	ON
Hotkey	[Num Lock] + [-]
Logout Timeout	OFF
Beeper	ON
OSD Language	English

9. Specifications

Console Connections	
Local	1 (Share Remote Bus)
Remote	1
Computer Connections	
Direct	16
Maximum	136 (via Daisy-chain with B022-U08)
Port Selection	OSD, Hotkey, Pushbutton
Connectors	
Console Ports	2 x USB-A Female (White) 1 x 6-pin Mini-DIN Female (Purple) 1 x 6-pin Mini-DIN Female (Green) 1 x HDB-15 Female (Blue)
External Mouse Port	1 x USB-A Female
KVM Ports	16 x RJ45 Female
Daisy-Chain Ports	1 x DB-25 Male
Firmware Upgrade	1 x RJ11 Female
LAN Ports	1 x RJ45 Female
Power	1 x IEC 60320/C14
Switches	
Port Selection	16 x Pushbutton
Station Selection	2 x Pushbutton
Reset	1 x Semi-recessed Pushbutton
Firmware Upgrade	1 x Slide Switch
Power	1 x Rocker Switch
LCD Power	1 x Pushbutton
LCD Adjustment	4 x Pushbutton
LEDs	
Online	16 (Green)
Selected	16 (Orange)
Station Selection	2 x 7 Segments (Orange)
Link	1 (Green)
10/100/1000 Mbps	FHD: 100/1000 Mbps (Orange / Green)
Power	1 (Blue)
LCD Power	1 (Orange)
Lock	1 x Num Lock (Green) 1 x Caps Lock (Green) 1 x Scroll Lock (Green)
Video	
Local / Remote	FHD: 1920 x 1200 @ 60 Hz

9. Specifications

Panel Spec	
LCD Module	19" TFT-LCD
Resolution	1280 x 1024 @ 75 Hz
Pixel Pitch	0.294 mm x 0.294 mm
Response Time	5 ms
Viewing Angle	170° (H), 160° (V)
Support Color	16.7M colors
Contrast Ratio	1000:01
Luminance	250 cd/m2
Emulation	
Keyboard / Mouse	PS/2; USB
Scan Interval	1-255 sec.
Maximum Input Power Rating	100-240V AC, 50-60 Hz, 1A
Power Consumption	AC 110V: 24.4W: 125 BTU AC 220V: 25.4W: 130 BTU
Environmental	
Operating Temperature	32 ~104°F (0 ~ 40°C)
Storage Temperature	-4 ~140°F (-20 ~ 60°C)
Humidity	0-80% RH, Non-condensing
Physical Properties	
Housing	Metal
Weight	33.92 lb. (15.4 kg)
Dimensions	18.9 x 27.61 x 1.73 in. (48.00 x 70.12 x 4.40 cm)

10. Warranty

1-YEAR LIMITED WARRANTY

We warrant our products to be free from defects in materials and workmanship for a period of one (1) year from the date of initial purchase. Our obligation under this warranty is limited to repairing or replacing (at its sole option) any such defective products. Visit TrippLite.Eaton.com/support/product-returns before sending any equipment back for repair. This warranty does not apply to equipment which has been damaged by accident, negligence or misapplication or has been altered or modified in any way.

EXCEPT AS PROVIDED HEREIN, WE MAKE NO WARRANTIES, EXPRESS OR IMPLIED, INCLUDING WARRANTIES OF MERCHANTABILITY AND FITNESS FOR A PARTICULAR PURPOSE. Some states do not permit limitation or exclusion of implied warranties; therefore, the aforesaid limitation(s) or exclusion(s) may not apply to the purchaser.

EXCEPT AS PROVIDED ABOVE, IN NO EVENT WILL EATON BE LIABLE FOR DIRECT, INDIRECT, SPECIAL, INCIDENTAL OR CONSEQUENTIAL DAMAGES ARISING OUT OF THE USE OF THIS PRODUCT, EVEN IF ADVISED OF THE POSSIBILITY OF SUCH DAMAGE. Specifically, we are not liable for any costs, such as lost profits or revenue, loss of equipment, loss of use of equipment, loss of software, loss of data, costs of substitutes, claims by third parties, or otherwise.

Regulatory Compliance Identification Numbers

For the purpose of regulatory compliance certifications and identification, your product has been assigned a unique series number. The series number can be found on the product nameplate label, along with all required approval markings and information. When requesting compliance information for this product, always refer to the series number. The series number should not be confused with the marking name or model number of the product.

WEEE Compliance Information for Customers and Recyclers (European Union)



Under the Waste Electrical and Electronic Equipment (WEEE) Directive and implementing regulations, when customers buy new electrical and electronic equipment from Eaton, they are entitled to:

- Send old equipment for recycling on a one-for-one, like-for-like basis (this varies depending on the country)
- Send the new equipment back for recycling when this ultimately becomes waste

Warning

Use of this equipment in life support applications where failure of this equipment can reasonably be expected to cause the failure of the life support equipment or to significantly affect its safety or effectiveness is not recommended.

Eaton has a policy of continuous improvement. Specifications are subject to change without notice. Photos and illustrations may differ slightly from actual products.



Powering Business Worldwide

Eaton
1000 Eaton Boulevard
Cleveland, OH 44122
United States
Eaton.com

© 2024 Eaton
All Rights Reserved
Publication No. 24-03-197 / 93-4806_RevB
April 2024



Eaton is a registered trademark.

All trademarks are property
of their respective owners.